

ACOUSTICS

12" SB34NRX75-6

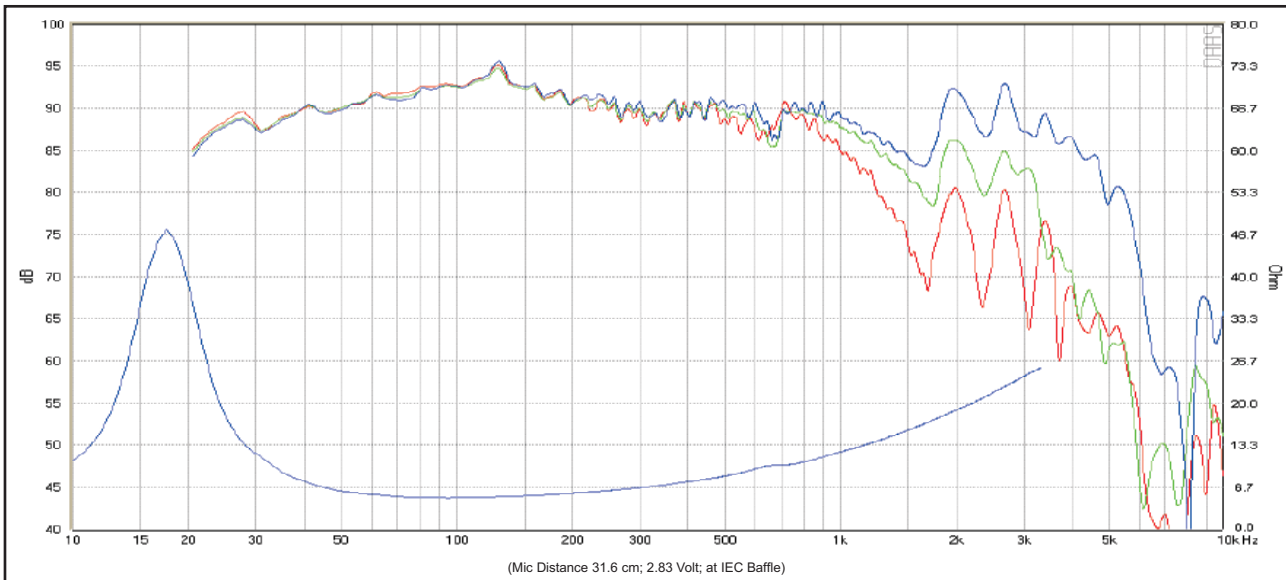
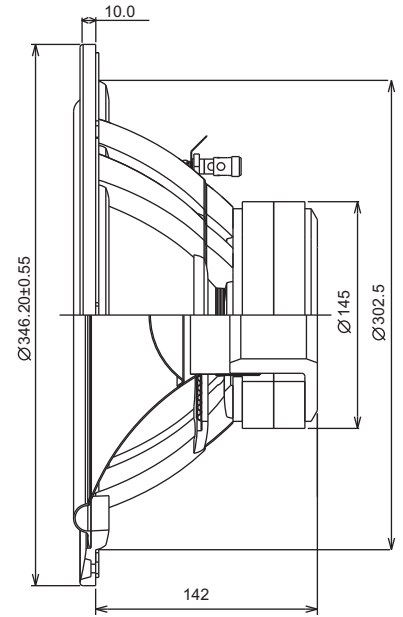
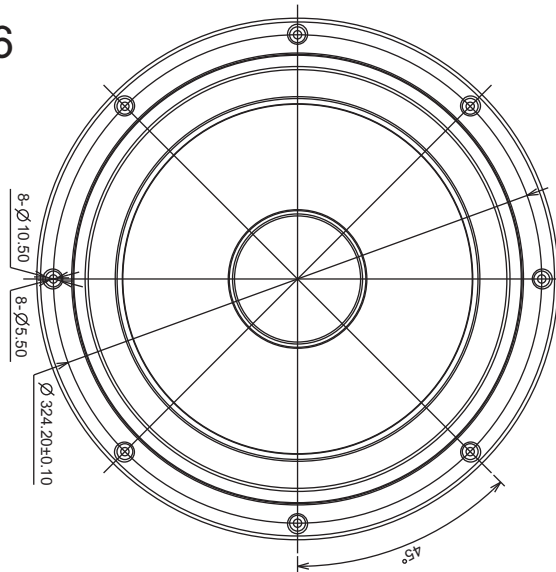

Response Curve :

— (Blue) : on axis — (Green) : 30 off-axis — (Red) : 60 off-axis

Specs :

Nominal Impedance	6 Ω	Free air resonance, Fs	19 Hz
DC resistance, Re	4.2 Ω	Sensitivity (2.83 V/1m)	90 dB
Voice coil inductance, Le	1.8 mH	Mechanical Q-factor, Qms	5.1
Effective piston area, Sd	508 cm ²	Electrical Q-factor, Qes	0.43
Voice coil diameter	75.6 mm	Total Q-factor, Qts	0.40
Voice coil height	28 mm	Moving mass incl.air, md	99 g
Air gap height	6 mm	Force factor, Bl	10.7 Tm
Linear coil travel (p-p)	22 mm	Equivalent volume, Vas	260 liters
Magnetic flux density	0.9 T	Compliance, Cms	0.71 mm/N
Magnet weight	2.1 kg	Mechanical loss, Rm	2.3 kg/s
Net weight	5.85 kg	Rated power handling	200 watt

The parameter are measured on drive units that are broken in