



# Plena Public Address Solutions



- ▶ High quality
- ▶ Ideal for small-to-mid-sized applications
- ▶ Easy expandability
- ▶ Easy to install and maintain

Plena Solutions can be used to tailor the public address system to the precise needs of small-to-mid-sized locations.

Plena offers facilities for background music, paging and playing pre-recorded commercials and additional power for applications such as hotels, offices and shopping malls.

Find below our latest back ground music source products.

## Ordering Information

Product Placeholder	CTN
<b>Accessories</b>	
<b>PLN-2AI0120 BGM/Paging System</b> all-in-one solution to cover background music (BGM), announcements and paging people	<b>PLN-2AI0120</b>
<b>PLN-DVDT Plena BGM Source</b> high-quality source for background music (BGM) in public address systems.	<b>PLN-DVDT</b>

**Americas:**

Bosch Communications Systems  
12000 Portland Avenue South  
Burnsville, Minnesota 55337, USA  
Phone: +1-800-392-3497  
Fax: +1-800-955-6831  
audiosupport@us.bosch.com  
www.boschsecurity.com

**Europe, Middle East, Africa:**

Bosch Security Systems B.V.  
P.O. Box 80002  
5600 JB Eindhoven, The Netherlands  
Phone: +31 40 2577 284  
Fax: +31 40 2577 330  
emea.securitysystems@bosch.com  
www.boschsecurity.com

**Asia-Pacific:**

Robert Bosch (SEA) Pte Ltd  
11 Bishan Street 21  
Singapore 573943  
Phone: +65 6571 2600  
Fax: +65 6571 2698  
apr.securitysystems@bosch.com  
www.boschsecurity.com

**Represented by**

# Plena Public Address Solutions

A flexible approach to sound management



**BOSCH**

Invented for life



## Your easy-to-expand **public address system**

Whether it is a local supermarket, a larger retail chain, an office complex, warehouse, or a popular self-service lunch spot, every location is unique with its own specific requirements. This is why the Bosch engineers designed this comprehensive and highly functional range of public address equipment.

Plena Public Address Solutions can be used to tailor virtually any public address system to the precise needs of small-to-mid-sized locations. It can develop to an extensive, multi-zone public address configuration with digital messaging, automated functions and additional power capability.

A qualified Bosch dealer will be more than happy to advise which Plena Public Address Solutions are best suited to the site and desired functionality. Bosch dealers can help you automate your current Plena system with a digital message manager and weekly timer, increase your input options with a background music source or even help you extend your system's power capabilities. With Plena Public Address Solutions, extending a public address system or integrating time-saving automation is easy and efficient.

Sturdy and durable, all Plena Public Address Solutions by Bosch are built to last without overlooking user-friendly functionality, sound quality and speech intelligibility.



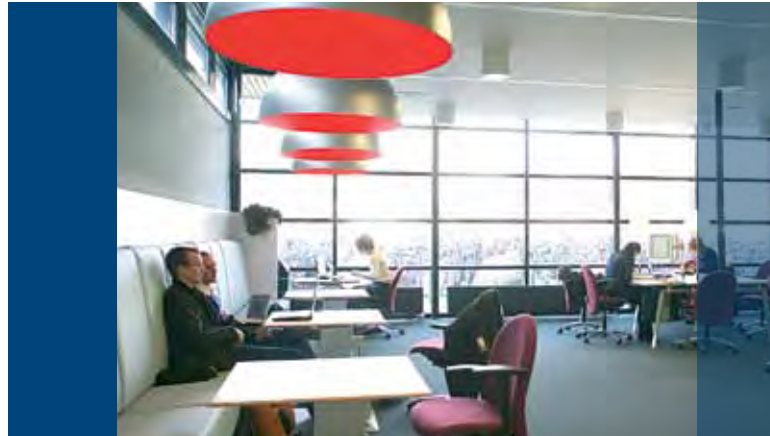

Improve speech intelligibility in difficult acoustic environments

Time your messages and music levels

Announcements in up to 6 zones

High performance system pre-amplifiers for every application

Loop amplifier for users of hearing aids



Watching, listening, mixing and amplifying in one device

Extra power for large spaces or distances

Listen to the radio, a CD or watch a DVD





## System Pre-Amplifier

- ▶ Six-zone capability
- ▶ Two inputs for multiple loop-through call stations
- ▶ Separate music and call channels with dedicated tone controls
- ▶ Emergency input with Voice Activated Switching (VOX)
- ▶ Selectable alarm tone, time signal and chimes

This high performance, versatile public address pre-amplifier features single channel and dual channel operation for simultaneous calls and background music. Extremely flexible with up to six-zone coverage, this amplifier is designed to be used with the Plena message manager/timer and Plena amplifiers.

## Power Amplifiers

- ▶ EN 54-16, ISO 7240-16 and EN 60849 certified (evacuation standards)
- ▶ 120 W\*, 240 W, 480 W and 1000 W units
- ▶ 70 V, 100 V and low-impedance outputs
- ▶ Temperature-controlled fan
- ▶ 3 inputs with priority switching

Compact, these power amplifiers with pilot tone supervision are available in 120 W, 240 W, 480 W and 1000 W versions. Highly dependable and solidly built, these amplifiers are protected against overload, short circuits and overheating. With 100 V - 8 ohm (70 V - 4 ohm) main power and a 24 V backup power connection, they provide the required power for any application.

\* not EN54/ISO7240 certified





## All-in-One BGM/Paging System

- ▶ **Out-of-the-box solution for music and announcements**
- ▶ **Dual zone 120 W mixer amplifier**
- ▶ **Emergency input with Voice Activated Switching (VOX)**
- ▶ **DVD/CD player with MP3 compatibility**
- ▶ **Digital FM tuner with 10 presets**

A versatile audio/video solution for background music, announcements, paging and video presentation, this all-in-one unit is easy to install and use. Practical and universally compatible, users can listen to the radio and play DVDs and CDs including MP3-encoded discs.



**DVD/CD player**



**2 zones**







## BGM Source

- ▶ **Seperate tuner and disc output**
- ▶ **Professional DVD/CD player with MP3**
- ▶ **Combined radio and disc output with automatic switch over**
- ▶ **Digital FM tuner with 10 presets**
- ▶ **Simultaneously plays images and music from a single disc**

This professional-quality DVD/CD player lets users program up to 999 MP3 tracks. Thanks to separate outputs, the radio and DVD/CD player can operate simultaneously.



## Feedback suppressor

- ▶ **Acoustic feedback suppression based on unique patented algorithm**
- ▶ **Suppresses feedback before it occurs**
- ▶ **Easy-to-install and operate**
- ▶ **2 input automatic microphone mixer**
- ▶ **Superb audio performance**

Any installation with a microphone and speakers in the same room can benefit from this professional quality feedback suppressor with sophisticated digital sound processing to maintain top quality sound. With 2 microphone inputs and a built-in auto-mixer, it's extremely easy-to-use, making it a popular choice in houses of worship, community centers, boardrooms and small-scale conference facilities.





## Message Manager

- ▶ Stores 12 prerecorded messages
- ▶ 12 trigger inputs with front-panel and remote control capability
- ▶ Zone control for the Plena system pre-amplifier
- ▶ EN 60849 compliant for emergency sound systems

This highly flexible stand-alone digital message manager plays up to 12 messages in WAV format via either trigger inputs or buttons. Users can easily create, manage and upload messages.

## Weekly Timer

- ▶ Two schedules possible
- ▶ Starts timed messages in combination with message manager
- ▶ Operation of up to 6 contact outputs
- ▶ Timed music level control
- ▶ Back-up battery keeps clock running

This accurate digital timing unit is suited for schools, retail chains and shopping malls, office buildings and other venues that need regularly timed messages, signals or automatic actions. Besides automated messages, the system can also be programmed to save energy, shutting off lights and stopping escalators.





## Loop Amplifier

- ▶ High power loop amplifier for up to 600 square meters (6458 sq. feet)
- ▶ Two mic/line inputs
- ▶ Built-in limiter and automatic volume control (AVC)
- ▶ Metal loss compensation
- ▶ EN 60849 compliant

An ideal way to integrate a solution for assistive listening device users, this loop amplifier is a cost effective unit designed to drive an installed wire loop located in either the floor or ceiling.





## Charger

- ▶ **EN 54-4 certified**
- ▶ **Fully supervised 12 A battery charger**
- ▶ **Under-voltage and over-voltage protection**
- ▶ **6x 40 A, 3x 5 A outputs**
- ▶ **150 A back-up current**

An intelligent, microprocessor-controlled (24 V) charger guarantees that the system batteries are always charged. Rack-mountable, it charges lead-acid batteries and simultaneously provides 24 V for system components that use 24 V exclusively. This charger is fully compliant and certified to EN 54-4.

## Call stations

- ▶ **All-call and six-zone call stations**
- ▶ **Uni-directional condenser microphone on a flexible stem**
- ▶ **Excellent speech quality**
- ▶ **Matching tabletop condenser microphone**
- ▶ **6 zone call station features selectable gain and speech filter.**

Available with or without chimes, all call stations have a flexible stem condenser microphone with a sturdy metal base for excellent stability or flush-mounting.





As a world-class expert with industry-leading research and development, Bosch is known around the world for premium communications products and systems.

A company synonymous with innovation, quality and reliability, Bosch consistently introduces trustworthy yet versatile products based on years of experience and close customer interaction.

**For more information about the Plena Easy Line Range, Plena Public Address Solutions and Plena Voice Alarm products, please feel free to contact your nearest Bosch representative or visit our website: [www.boschsecurity.com](http://www.boschsecurity.com)**



### **A Tradition of Quality and Innovation**

For over 100 years, the Bosch name has stood for quality and reliability. Bosch is the global supplier of choice for innovative technology, backed by the highest standards for service and support.

Bosch Security Systems proudly offers a wide range of security, safety, communications and sound solutions that are relied upon every day in applications around the world, from government facilities and public venues to businesses, schools and homes.



### **Bosch Security Systems**

To learn more about our product offering, please visit [www.boschsecurity.com](http://www.boschsecurity.com) or send an e-mail to [emea.securitysystems@bosch.com](mailto:emea.securitysystems@bosch.com)

© Bosch Security Systems, 2011  
Modifications reserved  
Printed in The Netherlands  
PA-EH-en-01\_F01U519328\_02

# Bosch Plena Public Address

Weekly Timer in shopping malls



**BOSCH**

Invented for life



# Bosch Plena Weekly Timer in shopping malls



## Summary of requirements

- **Scheduled BGM volume level settings**
- **Announcing opening and closing times**
- **Broadcasting promotional messages at preset times**
- **Broadcasting standard announcements at regular intervals**
- **Switching external events or systems**

## Shopping malls

Public address systems in small to medium-sized shopping malls typically incorporate several zones, including public walkways, parking garages and shops. Certain zones require background music (BGM) while others need only to receive public announcements. National and international regulations can demand a future upgrade to voice alarm functionality.

## Introduction

Bosch Plena public address meets the requirements of shopping malls and similar applications. The family of call stations, system amplifiers, power amplifiers and auxiliary units like the message manager and timer are easily combined to produce tailored-made configurations. Moreover, Plena offers a cost-effective combined solution for an EVAC-certified voice alarm system with full public address functionality.

## Solution

The Plena Timer offers a perfect solution together with the Plena Voice Alarm System or the Plena Message Manager. It can be programmed to perform two different week schedules. Every minute can be programmed for a specific event, and each event can contain a BGM volume level change, a chime or a switched combination of the six contact outputs to trigger pre-recorded announcements.

## BGM level control

The BGM level control adjusts the volume of a BGM source (connected to the timer) at user-programmable preset times. For example, if shopping mall is located close to a residential area, the BGM volume can be reduced at specific times to prevent noise pollution.





**Announcements at preset times**

Some announcements, such as pickpocket warnings or reminding shoppers that closing time is approaching, are always broadcast at preset times. Other announcements, such as advertisements for sales actions, will only be required at preset times for a limited period. The Timer caters for both these types of announcements. Furthermore the unit can be programmed to broadcast one of the built-in 14 chimes or to control external devices, such as locks or decorative lighting, for example, to switch off storefront displays 30 minutes after closing time.

**Easy to use and configure**

The clear user interface is designed to enable timer settings to be entered directly via the front panel controls or via the user-friendly PC configuration program (supplied). Features such as automatic Summer/Wintertime adjustment are built in to further simplify operation.

**Typical Event Schedule**

Shops open at 9.00 AM, close at 7.00 PM

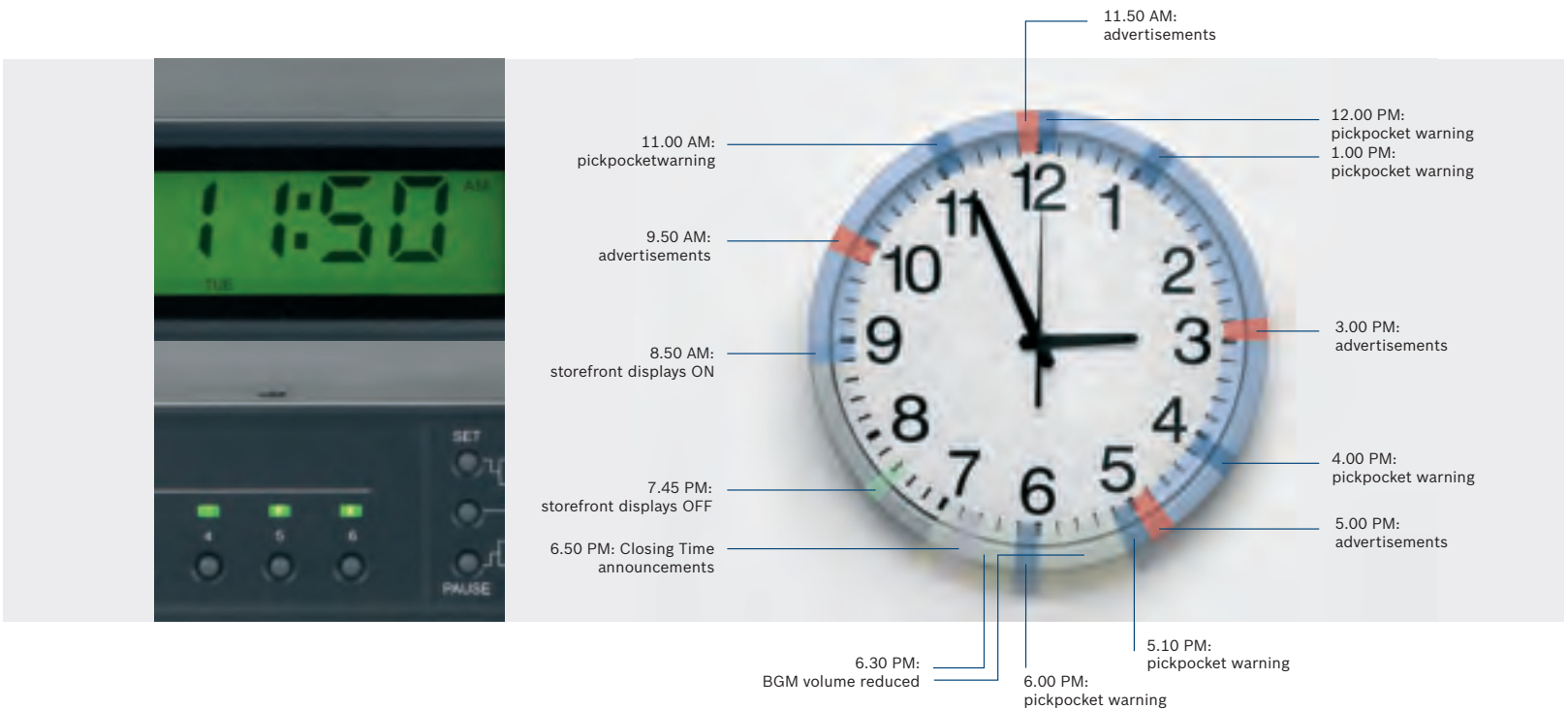

**Bosch Security Systems**

For more information please visit  
[www.boschsecurity.com](http://www.boschsecurity.com)

Printed in The Netherlands  
Data subject without notice  
PA-EH-en-06\_F01U517689\_02

**Tradition of quality and innovation**

For over 100 years, the Bosch name has stood for quality and reliability. Bosch Security Systems proudly offers a wide range of fire, intrusion, social alarm, CCTV, management and communication systems and components to help you find the solution for any application. We are the global supplier of choice for innovative technology backed by the highest level of service and support. When you need solutions you can rely on, choose Bosch.

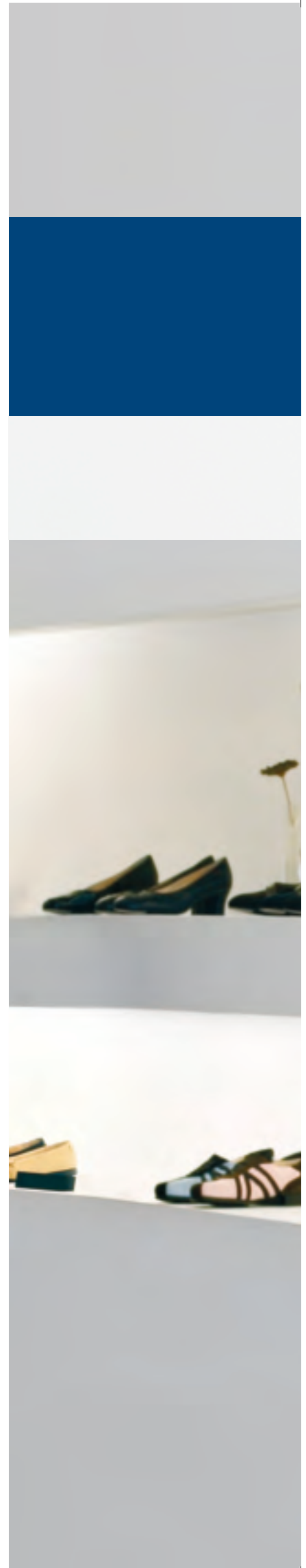

## Application Note

### Counter Induction Loop



**BOSCH**

Invented for life

**Consulting**

Jack van de Watering

+31 76 57 21 407

jack.vandewatering@nl.bosch.com

**Update**

07/08/2007

**Version**

V\_00

## Table of Contents

<b>Table of Contents</b>	<b>2</b>
<b>1. Introduction</b>	<b>3</b>
<b>2. Loop design</b>	<b>4</b>
<hr/>	
2.1 Dimensions and placement	4
2.2 Explanation of operation	4
2.3 Construction of the loop	4
2.4 Microphone	5

## 1. Introduction

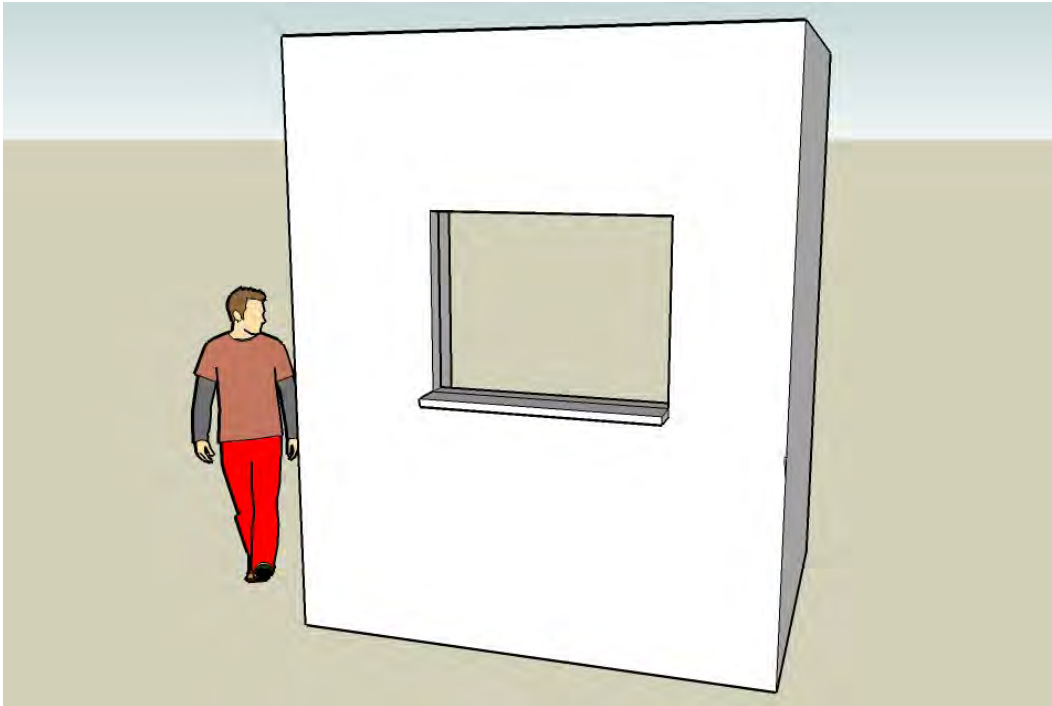

Although the Plena Loop Amplifier is primarily intended for inductive loops covering large areas it is even suitable for a small application like a counter inductive loop. The solution will allow the customer to fulfill all his need for assistive listening devices with just one type of equipment.

## 2. Loop design

### 2.1 Dimensions and placement

Recommended is a square loop size of 80 cm x 80 cm. It is folded and placed as indicated in red on the picture.

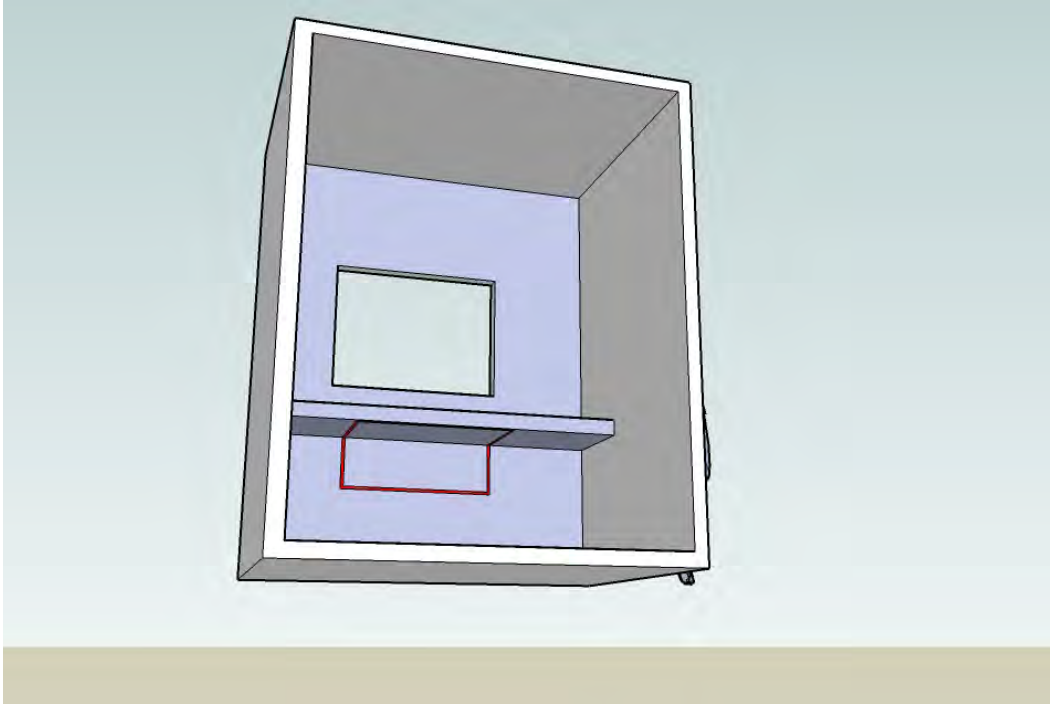

The loop size is not very critical. A variation in size will not have a significant effect on correct operation, although it can have some effect on the adjustment of the signal in the loop. If required the loop can have a larger width to cover a bigger counter width. The depth of the loop can be less when the table at the back office side is smaller.

### 2.2 Explanation of operation

A loop which is folded in the way described here actually behaves like a loop which is tilted at an angle of 45°, thus aiming at the chest of the visitor at the counter. The field lines will curve in such a way that they are close to vertical at the position of the hearing aid. This means that the field strength will be maximized for the visitor.

### 2.3 Construction of the loop

For adequate field strength the loop should have approximately 4 windings. The impedance of the loop wiring should be between 1 and 3  $\Omega$ , which can be achieved with an AWG28 cable or cable with similar core diameter.

# Hearing aid assistance in public buildings

- ▶ 2 unique solutions for Public Address and Conferences
- ▶ Excellent sound reproduction for announcements and music
- ▶ Excellent speech intelligibility



**BOSCH**  
Invented for life



## A choice of two solutions

Hearing aid users must be able to hear announcements in public buildings and take part in conferences, places of worship and other gatherings. In public spaces, high background sound levels and long reverb make it difficult to understand speech. Just turning up the hearing aid sensitivity causes various kinds of discomfort.

To ensure equal opportunities for people with disabilities, more and more countries are introducing legislation (such as the Disability Discrimination Act in the UK). Bosch offers two solutions for hearing aid users, and both make use of the standard T-mode (telecoil) setting on hearing aids.

**The first solution** is a cost-effective single-channel system based on the Plena Loop Amplifier. This solution enables hearing aid users in the area enclosed by the wire loop to hear all announcements and music.

**The second solution** is a multi-channel system based on the Integrus infrared (IR) wireless language distribution system. This approach can also be used for applications where it is not possible (or viable) to install a wire loop.

# Solution with Induction Loop System

## Places of worship

This solution enables hearing aid users in churches, mosques and synagogues to hear via the T-mode of their hearing aids. It is also suitable for indoor applications such as theaters, cinemas, courtrooms, lecture halls and situations where the public are in a single area or auditorium.

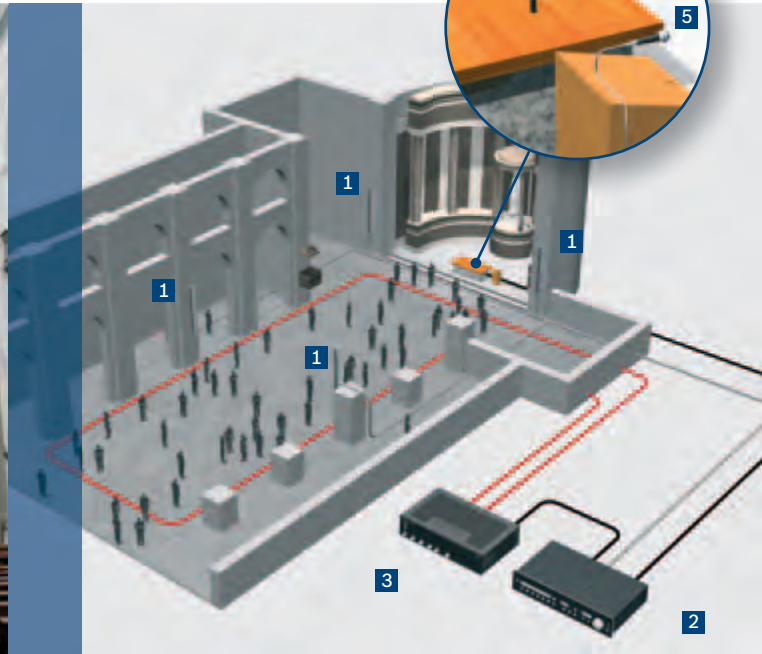

(See config. table at backside)

## Introduction

The hearing enjoy speech and song reproduction via an amplifier/loudspeaker configuration optimized for specific acoustic conditions (the Plena Mixer Amplifier with XLA Line Array Loudspeakers is a typical configuration for reverberant buildings with hard surfaces). Such a system is easily expanded to cater for hearing aid users by installing a loop amplifier and a wire loop around the listening area.

## Summary of requirements

- Sermon/proceedings in one language only
- Congregation/audience in one area up to 600 m<sup>2</sup>

## Solution

The Plena Loop Amplifier drives a loop installed into the floor or ceiling in an area up to 600 m<sup>2</sup>. In this example, the loop amplifier is connected to a mixing amplifier's line-level output. In the T-mode, hearing aid users benefit from enhanced speech intelligibility and good music reproduction.

## Compliance

Reliable T-mode compatibility for hearing aid users is also essential for emergency evacuation. The Plena Loop Amplifier has full supervision, a fault output and a priority input making it suitable for IEC60849 compliant voice alarm systems. Also it is EN60118-4 compliant, the recognized standard for induction loop installations.

## Easy to install and expand

Installation requires a single induction loop to be built into the floor or ceiling around the listening area and a connection to the Plena Loop Amplifier output. Since the Plena Loop Amplifier is stackable (master/slave configuration), low spill schemes are also supported. It provides uniform field strengths over very large areas without the need for additional equipment. This is useful for applications like multi-screen cinemas.



# Solution with Infrared System

## Conference hall assemblies

In conference hall assemblies, hearing aid users must have a reliable means of following meetings and proceedings. This solution is also suitable for cinemas and theaters, and in applications spread over several rooms such as museums and conference centers with breakout rooms.

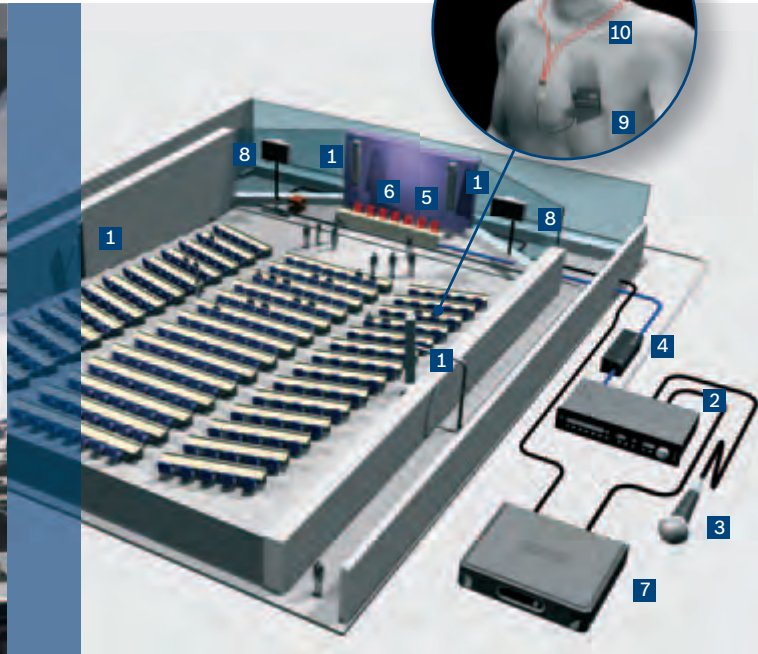

(See config. table at backside)

## Introduction

The solution for multi-room or large area applications uses a wireless language distribution system, and hearing aid users with receivers with an inductive loop neckband. This system provides extra freedom of movement and gives the hearing aid wearer a choice of channels, allowing different languages (where interpretations are provided) or special confidential information to be listened to.

## Summary of requirements

- multiple adjacent rooms, with each their own meeting
- confidential meetings
- a choice of languages may be provided

## Solution

The Bosch Integrus is a digital IR language distribution system with up to 32 channels. It connects to a conference or discussion system (like the Bosch CCS 800 Ultro or DCN) or a public address system, and transmits the proceedings

via Integrus radiators to carriers of Integrus receivers. For the hearing aid users, an inductive loop neckband is connected to the receiver and hung around the neck to make an inductive coupling to the hearing aid.

Integrus radiators provide large coverage, ensuring excellent reception over a large area. The system is immune to interference from lighting and bright sunlight. Its digital technology preserves audio quality, so users of the Integrus clearly hear the speech and music via an inductive loop neckband and their hearing aids. IR transmission also increases privacy, as signals do not pass through walls or ceilings. This example uses four CCS 800 Ultro discussion units connected via a control unit to the Integrus transmitter. Bosch XLA Line Array Loudspeakers for the hearing and a microphone on a long lead for public input are also included.



### Configuration for application 1

LBC 3201/00	XLA 3200 Line Array Speaker 60 W	: 4x	<b>1</b>
PLE 2MA120	Plena Mixer Amplifier 120 W	: 1x	<b>2</b>
PLN 1LA10	Plena Loop Amplifier 10 A	: 1x	<b>3</b>
LBB 1949/00	Condenser Gooseneck Microphone	: 1x	<b>4</b>
LBC 2900/xx	Unidirectional Dynamic Handheld Microphone	: 1x	<b>5</b>

### Configuration for application 2

LBC 3201/00	XLA 3200 Line Array Speaker 60 W	: 4x	<b>1</b>
PLE 2MA120	Plena Mixer Amplifier 120 W	: 1x	<b>2</b>
LBB 2900/xx	Unidirectional Dynamic Handheld Microphone	: 1x	<b>3</b>
CCS-CU	CCS 800 Ultro Control Unit	: 1x	<b>4</b>
LBB 3331/00	CCS 800 Ultro Chairman Unit	: 1x	<b>5</b>
LBB 3330/00	CCS 800 Ultro Delegate Unit	: 1x	<b>6</b>
INT-TX04	Integrus 4-Channel Transmitter	: 1x	<b>7</b>
LBB 4512/00	Integrus High Power Radiator	: 2x	<b>8</b>
LBB 4540/04	Integrus 4-Channel Receiver	: 10x	<b>9</b>
HDP-ILN	Inductive Loop Neckband	: 10x	<b>10</b>

© **Bosch Security Systems, 2008**

To learn more about our product offering,  
please visit [www.boschsecurity.com](http://www.boschsecurity.com)  
or send an e-mail to  
[emea.securitysystems@bosch.com](mailto:emea.securitysystems@bosch.com)

# Plena Feedback Suppressor

## Press rooms



Security Systems



The Plena Feedback Suppressor is an easy-to-use solution for press rooms suffering from acoustic feedback. It uses a DSP to suppress acoustic feedback by actively filtering out unwanted room reverb. By shifting the frequency of the output signal by 5 Hz or by adding inaudible noise to the output signal, it detects the reverb component of a signal and removes it before feedback occurs. A built-in 2-input mixer allows two microphones to be used to capture the voice of a moving speaker without increasing the risk of acoustic feedback. It does this by automatically reducing the gain of the microphone with the weakest signal and increasing the gain of the microphone with the strongest signal, thus tracking the moving speaker and optimizing speech intelligibility. The feedback suppressor's adaptive filter has a fast mode (for where the microphone positions change over time) and an accurate mode (for fixed microphone positions).

### Press rooms:

This application note describes how the Plena Feedback Suppressor overcomes potential acoustic feedback problems in press rooms and other applications where two non-fixed microphones are used to allow journalists to ask questions to participants in a press conference.

### Introduction:

Press rooms require loudspeakers to clearly relay the proceedings of a conference (possibly in another room or venue) to the journalists. And even when microphones are positioned reasonably far away from these loudspeakers, it is not always possible to avoid feedback. If the person asking the question is unaware of the possibility of feedback, he or she may not speak loudly and clearly enough in the microphone, thus requiring extra amplification by the sound system. Since such a microphone is not in a fixed position, the feedback path constantly changes.

**Summary of requirements:**

- 2 non-fixed microphones for journalists
- Fixed or temporary installations
- No acoustic feedback
- Quality loudspeakers with excellent speech intelligibility
- Conference system for press conference panel

**Solution:**

This situation requires fast adaptive feedback suppression as provided by the Plena Feedback Suppressor. Two microphones (4) for the press to ask questions are connected via the two XLR microphone inputs of the feedback suppressor. During operation, the feedback suppressor (1) automatically selects the microphone with the strongest signal, thus avoiding feedback from the unused microphone. The output signal of the feedback suppressor is fed into one of the inputs of a Plena Mixer Amplifier (3).

**Integrated conference system:**

In addition, a CCS 800 Ultro Congress System (5) for use by participants in the press conference itself is connected to the same Plena Mixer Amplifier.

**Line array loudspeakers:**

Two LBC 3200/00 Line Array Loudspeakers (2) completes the system. Despite their small size, these loudspeakers deliver excellent speech intelligibility and can cover a large area, making them particularly suitable for this kind of application. For coverage of an even larger area, additional loudspeakers can be installed at appropriate intervals.

**Easy set-up:**

In common with all Plena equipment, the Plena Feedback Suppressor is easy to set-up according to the ‘plug and play’ philosophy. The suppression process is completely automatic, and does not require the manual setting up of unpredictable filters to achieve perfect results. The LBC 3200/00 Loudspeaker is also easy to adjust for a specific coverage area by determining the appropriate mounting height using a chart supplied with the loudspeakers. This means that the complete installation can be installed and functionally optimized without the need for specific expertise.

Configuration		
<b>LBB 1968/00</b>	Plena Feedback Suppressor	: 1 x (1)
<b>LBC 3200/00</b>	XLA 3200 45/30 W Line Arrays	: 2 x (2)
<b>LBC 1906/10</b>	Plena 90/60 W Mixer Amplifier	: 1 x (3)
<b>LBC 2900/xx</b>	Dynamic hand-held microphone	: 2 x (4)
<b>CCS 800 Ultro Congress System</b>		(5)

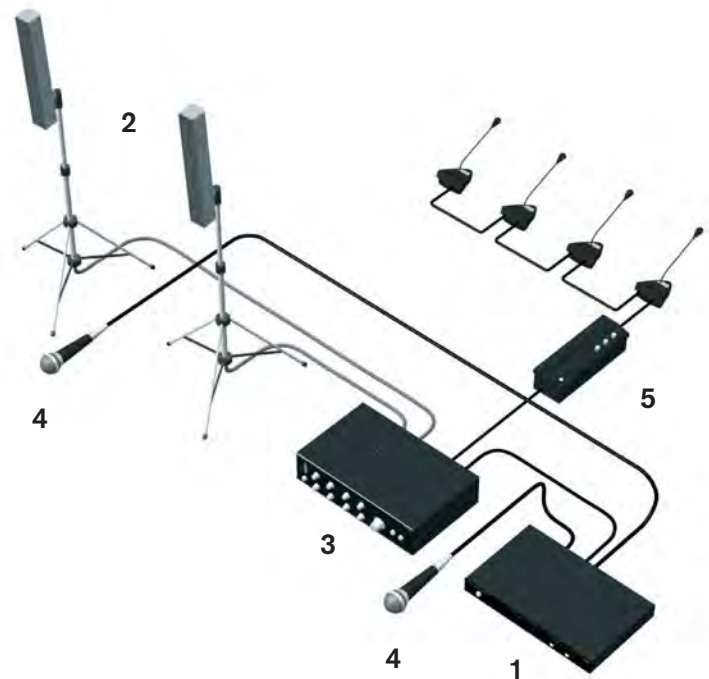

Bosch Security Systems  
 For more information please visit  
[www.boschsecuritysystems.com](http://www.boschsecuritysystems.com)



# Plena Feedback Suppressor Places of worship



Security Systems

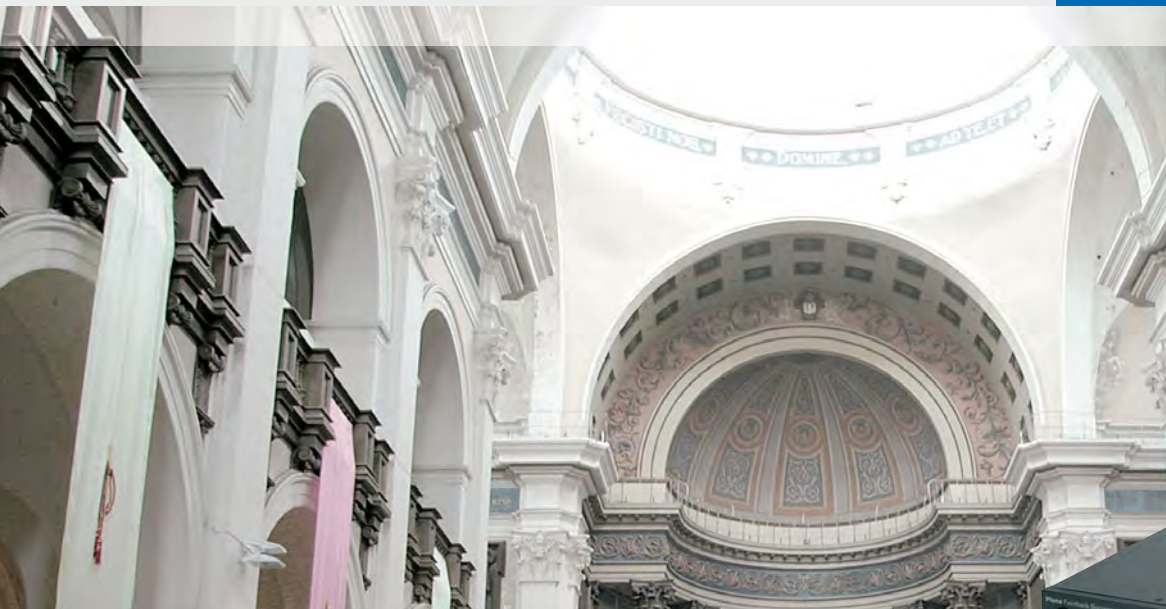

The Plena Feedback Suppressor is an easy-to-use solution for reducing acoustic feedback in places of worship. It uses a DSP to suppress feedback by actively filtering out unwanted room reverb. By shifting the frequency of the output signal by 5 Hz or by adding inaudible noise to the output signal, it detects the reverb component of a signal and removes it before feedback occurs. A built-in 2-input mixer allows two microphones to be used to capture the voice of a moving speaker without increasing the risk of acoustic feedback. It does this by automatically reducing the gain of the microphone with the weakest signal and increasing the gain of the microphone with the strongest signal, thus tracking the moving speaker and optimizing speech intelligibility. The feedback suppressor's adaptive filter has a fast mode (for where the microphone positions change over time) and an accurate mode (for fixed microphone positions).

## House of worship:

This application note describes how the Plena Feedback Suppressor overcomes potential acoustic feedback problems in houses of worship where typically several microphones are used, for example by the minister (or other religious leader) in the pulpit and alter, and another for the choir.

## Introduction:

In general, houses of worship are large rooms with hard surfaces such as marble, concrete, exposed brick, tiled walls and high ceilings. This type of environment is very reverberant, and when loudspeakers are carefully positioned for adequate coverage, there is an increased risk of feedback from any of the several microphones typically used in this type of venue.

**Summary of requirements:**

- Several fixed microphone positions
- No acoustic feedback
- Amplified sound should originate close to person speaking
- Quality loudspeakers with speech intelligibility and music reproduction

**Solution:**

The Plena Feedback Suppressor is an ideal solution for this type of application. It suppresses feedback before it even occurs and automatically adapts itself to the difficult acoustical environment. In this example, the feedback suppressor (5) is connected to the insertion sockets of a Plena Mixer Amplifier (2), using a dual cinch-to-cinch cable. In this way, the feedback suppression will be effective on the signals from all microphones. Up to four microphones (items 3 and 4) can be connected to this mixer amplifier. If necessary, additional microphones can be connected using a Plena Universal Preampfier.

**Line array loudspeakers:**

The LBC 3201/00 Line Array Loudspeakers (1) complete the system. They can cover a large area and deliver high-quality reproduction of both speech and song. The used line array technology provide an uniform sound distribution throughout the entire listening area, so not too loud at the front and no too quiet at the back. For a more extensive listening area, additional loudspeakers connected to delay units can be positioned further down the venue.

**Easy set-up:**

In common with all Plena equipment, the Plena Feedback Suppressor is easy to set-up according to the ‘plug and play’ philosophy. The suppression process is completely automatic, and does not require the manual setting up of unpredictable filters to achieve perfect results. The LBC 3201/00 Loudspeaker is also easy to adjust for a specific coverage area by determining the appropriate mounting height using a chart supplied with the loudspeakers. This means that the complete installation can be installed and functionally optimized without the need for specific expertise.

Configuration		
LBB 1968/00	Plena Feedback Suppressor	: 1 x (5)
LBC 3201/00	XLA 3201 90/60 W Line Arrays	: 4 x (1)
LBC 1912/10	Plena 180/120 W Mixer Amplifier	: 1 x (2)
LBC 1949/00	Gooseneck microphone	: 1 x (3)
LBC 2900/xx	Dynamic hand-held microphone	: 1 x (4)

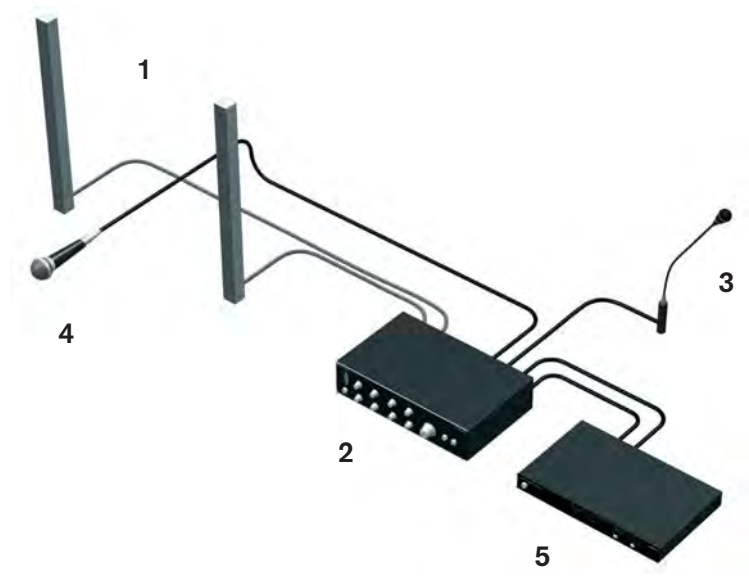

Bosch Security Systems  
 For more information please visit  
[www.boschsecuritysystems.com](http://www.boschsecuritysystems.com)



## 2.4 Microphone

The Loop Amplifier should also have a microphone connected. Due to the presence of a magnetic field a dynamic microphone cannot be used. An LBB1950/10 Plena Tabletop Unidirectional Condenser Microphone however is very suitable for this application. The microphone needs to be on permanently. Set this as follows:

1. Open the Call Station cover
  2. Set the internal switch to Toggle, without moving the keycap to the corresponding switch.
  3. Activate the toggle key
  4. Replace the call station cover
- ✓ The Call Station is on and cannot be operated with the PTT-key anymore.