

# Video Repair Parts



■ Video Heads .....	2	■ Cassette Housings .....	80
■ Akai / LG.....	5	■ Akai .....	80
■ Funai .....	5	■ Daewoo / Tempest.....	80
■ JVC.....	5	■ Funai / Teac / Palsonic.....	80
■ Hitachi .....	5	■ LG / Goldstar.....	80
■ Samsung.....	5	■ JVC / Philips.....	80
■ Video Head Cross Reference.....	6	■ Mitsubishi.....	81
■ AC Heads.....	8	■ Panasonic.....	81
■ Motors.....	9	■ Samsung.....	81
■ Akai .....	9	■ Sanyo.....	82
■ Daewoo.....	10	■ Sharp.....	82
■ Goldstar / LG.....	10	■ Sony.....	82
■ Funai / Teac / Palsonic.....	10	■ Tension Bands .....	83
■ Hitachi .....	10	■ Akai .....	83
■ JVC.....	11	■ Funai / Teac / Palsonic.....	83
■ LG / Goldstar.....	12	■ LG / Goldstar.....	83
■ Mitsubishi.....	13	■ Hitachi .....	84
■ NEC.....	14	■ JVC.....	84
■ National.....	14	■ Mitsubishi.....	84
■ Panasonic.....	14	■ NEC.....	85
■ Philips.....	15	■ Panasonic.....	85
■ Samsung.....	15	■ Samsung.....	85
■ Sanyo.....	16	■ Sanyo.....	86
■ Sharp.....	16	■ Sharp.....	86
■ Sony.....	19	■ Sony.....	87
■ Teac / Philips.....	19	■ Mode Switches.....	87
■ Video Belts .....	20	■ Akai .....	87
■ Cross Reference .....	20	■ Deitron / Tempest / Tracton.....	88
■ Belt Kits .....	22	■ Funai / Teac.....	88
■ Video Belts & Idler Tyres.....	23	■ Goldstar.....	88
■ Idler Tires.....	24	■ Hitachi .....	88
■ Pinch Rollers .....	25	■ JVC.....	89
■ Akai .....	25	■ LG.....	89
■ Daewoo.....	25	■ Mitsubishi.....	89
■ Funai / Teac.....	25	■ NEC.....	90
■ Goldstar / LG / NEC.....	25	■ National.....	90
■ Hitachi .....	25	■ Panasonic.....	91
■ JVC / Philips.....	26	■ Orion.....	91
■ Mitsubishi.....	26	■ Samsung.....	91
■ NEC.....	26	■ Sanyo.....	91
■ National.....	26	■ Sharp.....	92
■ Panasonic.....	27	■ Sony.....	93
■ Philips / Teac.....	27	■ Mode Sensors .....	94
■ Samsung.....	27	■ Universal Lamps.....	94
■ Sanyo.....	27	■ JVC.....	94
■ Sharp.....	27	■ Akai .....	94
■ Sony.....	27	■ Sharp.....	94
■ Video Pinch Roller Listing.....	28	■ LG / Goldstar.....	94
■ Overhaul Kits .....	30	■ National.....	94
■ JVC OEM.....	30	■ NEC.....	94
■ National Panasonic OEM.....	31	■ JVC.....	94
■ JVC Replacement.....	32	■ Sharp.....	94
■ National Panasonic Replacement.....	32	■ Rotational Sensor.....	94
■ Idlers & Gears .....	33	■ Reel Sensor.....	94
■ Akai .....	33	■ Infrared.....	94
■ Daewoo / NEC / AWA / Tempest.....	36	■ Components.....	94
■ Funai / Teac / Palsonic.....	38	■ Misc Parts .....	95
■ LG / Goldstar / NEC / Teac.....	40	■ Brake Pads.....	95
■ Hitachi .....	44	■ Misc Parts.....	95
■ JVC.....	45	■ Chroma.....	95
■ Mitsubishi / AWA.....	52	■ Switchmode Repair.....	95
■ NEC.....	54	■ Servicing Tools and Accessories.....	96
■ Orion.....	55		
■ Panasonic.....	55		
■ Samsung.....	63		
■ Sanyo / Fisher / Sony.....	66		
■ Sharp.....	68		
■ Sony.....	75		
■ Toshiba.....	79		
■ Teac / Philips.....	79		



## Video Heads

### VIDEO HEADS

All VCR Heads are of OEM quality. Please be careful when replacing the heads, as physically damaged items are not covered under warranty. For a head not listed here, please enquire as there may be substitutes available. VH=Upper Drum Only VHD=Upper & Lower Drum with Motor.

PLEASE REFER TO CROSS-REFERENCE LISTING FOR SUGGESTED MODELS

Replaces	Equiv.	Code
AMSTRAD 255015	FUNAI, TEAC 8059-08-05	VH146
AKAI BV-V1004A280A	BV-V1022A170A	VH50
AKAI BV-V1030A220D		VH55
AKAI BV-V1047A220A		VH56
AKAI BV-V1015A120A		VH57
AKAI BV-V1075A420G	BV-V1123A420A	VH58
AKAI BV-V1075A420B	BV-V1102A420E, V1123A420B	VH59
AKAI BV-V1039A120A		VH270
AKAI BV-V1102A420G	BV-V1102A420C, V1102A420D	VH285
AKAI BV-V1102A420D		VH286
AKAI BV-V1182A420B		VH288
AKAI BV-V1182A420E		VH289
AKAI BV-V1123A420C	CIRCUIT BOARD TYPE	VH290
AKAI BV-V1182D420A	CIRCUIT BOARD TYPE	VH291
AKAI BV-V1234D430E	PIN TYPE	VH293
DAE-WOO, TEMPEST 97SA217900		VH190
DAE-WOO, TEMPEST 97SA428700		VH191
DAE-WOO, TEMPEST 97SA428700		VH193
FUNAI, TEAC 8000-01-13		VH140
FUNAI, TEAC 8059-01-19		VH142
FUNAI, TEAC 8059-01-20		VH143
FUNAI, TANDY 8059-01-95		VH144
FUNAI, TEAC 8059-08-05 [SP]		VH145
FUNAI, TEAC NFN513		VH147
FUNAI, TEAC 62DD806501601		VH440
FUNAI, TEAC 620806501610		VH442
GOLDSTAR 413-014/50/51/75/98		VH180
GOLDSTAR 413-159A		VH182
GOLDSTAR/NEC 413165D		VH185
HITACHI 5458161	5458165	VH94
HITACHI 5458413, 5458415, 5458282	5.45899E+14	VH96
HITACHI 5458104	5458282	VH98
HITACHI 5458434	5459002	VH99
HITACHI 5459001		VH100
HITACHI 5457474		VH240
HITACHI 5436103		VH245
HITACHI 5457471		VH248
HITACHI 5457472		VH249
JVC PU31332D	PU31332-GIO	VH10
JVC PU31332J		VH12
JVC PU31332L		VH14
JVC PQ20020B		VH15
JVC PQ20016B-2		VH16
JVC PQ20013C		VH17
JVC PU20850G		VH18
JVC PU31332F		VH20
JVC PDM2119		VH202
JVC PDM2001C-8		VH203
JVC PDM2004B		VH204
JVC PDM2007A		VH205
JVC PDM2112B		VH206
JVC PQ20014C/C4		VH207
JVC PDM3403C		VH210
JVC PRD2002D		VH214
JVC PDM2002C		VH215
JVC PDM2104B-9	PDM2104D	VH217
JVC PRD30050B		VH218
JVC PDM3353L		VH219
JVC PDM3353J14		VH420
JVC NKP0003LP	428869110625	VH425
MITSUBISHI 927B72302		VH119
MITSUBISHI 928B00804	928B00803	VH120
MITSUBISHI 928B22102		VH121
MITSUBISHI 928B334020		VH122
MITSUBISHI 927B499021		VH123

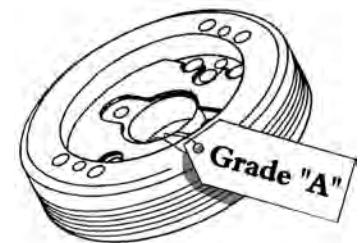

**MORE SUBSTITUTES  
AVAILABLE SEE:  
<http://www.wes.com.au/>**



## VIDEO HEADS Continued...

Replaces	Substitutes	Code
mitsubishi 928B79909		VH124
mitsubishi 928B17302	928B173050	VH125
mitsubishi 928B09004		VH126
mitsubishi 928B64109		VH127
mitsubishi 928B65409		VH128
mitsubishi 928B29602		VH130
mitsubishi 928B32207		VH132
mitsubishi 928B984021		VH133
mitsubishi 927B723014		VH134
mitsubishi 928B20702		VH135
mitsubishi 928B40409		VH136
mitsubishi 948B07002		VH137
mitsubishi 928B37107		VH138
mitsubishi 927B730021	928B65413 928B65407	VH139
NATIONAL VEH0103	VEH0131	VH30
NATIONAL VEH0322		VH31
NATIONAL VEH0366		VH32
NATIONAL VEH0339		VH33
NATIONAL VEH0416	VEH0386	VH34
NATIONAL VEH0417	VEH0385	VH36
NATIONAL VEH0288	VEH0279	VH37
NATIONAL VEH0265	VEH0231	VH38
NATIONAL VEH0343		VH39
NATIONAL VEH0121	VEH0115	VH40
NATIONAL VEH0171		VH41
NATIONAL VEH0177		VH42
NATIONAL VEH0201		VH43
NATIONAL VEH0209		VH44
NATIONAL VEH0252		VH45
NATIONAL VEH0218		VH46
NATIONAL VEH0267	VEH0256	VH47
NATIONAL VEH0287	VEH0270	VH48
NATIONAL VEH0286	VEH0295, VEH0296	VH49
NATIONAL VEH0352		VH201
NATIONAL VEH0225		VH298
NATIONAL VEH0269		VH299
NATIONAL VEH0300		VH300
NATIONAL VEH0323	VEH0324	VH303
NATIONAL VEH0400		VH304
NATIONAL VEH0415		VH305
NATIONAL VEH0433		VH310
NATIONAL VEH0467		VH315
NATIONAL VEH0454		VH317
NATIONAL VEH0531		VH319
NATIONAL VEH0532		VH320
NATIONAL VEH0548		VH330
NATIONAL VEH0598		VH335
NATIONAL VEH0599		VH336
NATIONAL VEH0601		VH337
NATIONAL VEH0653		VH340
NATIONAL VEH0679		VH343
NATIONAL VEH0712		VH346
NEC 824 23AH1		VH160
NEC 824 34AH1		VH161
NEC 826 11AH1		VH163
NEC 826 91AH1		VH164
NEC 82B 26AH1		VH165
NEC 827 63AH1		VH166
NEC NNC601		VH168
NEC 79V15036		VH172
NEC 79V15879		VH173
NEC 79V15041		VH174
ORION VH1, VH2		VH150
ORION VH3		VH155
TOSHIBA 70321968		VH89
TOSHIBA 70321320		VH91
TOSHIBA 70321488		VH92
TOSHIBA 70321994	70321827	VH93
TOSHIBA 70325174		VH389
TOSHIBA 70325185		VH390

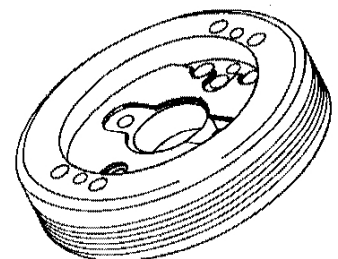
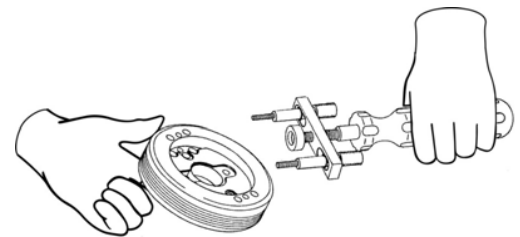
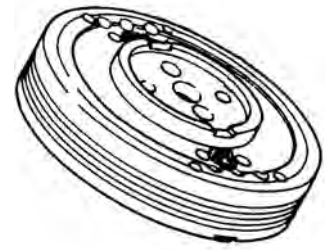

**MORE SUBSTITUTES  
AVAILABLE SEE:  
<http://www.wes.com.au>**



## VIDEO HEADS - Continued...

Replaces	Substitutes	Code
SAMSUNG 69000-390-013 (Grade "A")		VH77
SAMSUNG 69000-342-400		VH75
SAMSUNG 69000-390-012		VH76
SAMSUNG 69000-390-026		VH375
SAMSUNG 69020-124-042 (Head Only!)		VH376
SAMSUNG 69000-390-271		VH78
SANYO 613-022-0264	613-078-8672	VH79
SANYO 143-0-242V-22300/22400	143-0-242v-01700/002200	VH80
SANYO 143-0-771T-06500	143-0-771T-06800	VH81
SANYO 143-0-771T-13400	143-0-771T-09000	VH82
SANYO 143-0-762T-02000		VH85
SANYO 143-0-771T-06100	FISHER	VH87
SANYO 143-0-771T-25221		VH88
SANYO 613-096-8039		VH171
SANYO 613-164-0719		VH179
SANYO 613-166-2926		VH371
SANYO 143-0771T-09200		VH209
SHARP DDRMU0002HE09		VH21
SHARP DDRMU0004HE09	DDRMU0004HE12	VH22
SHARP DDRMU0001HE10		VH23
SHARP DDRMU0002HE04	DDRMU0002HE02 DDRMU0002HE05	VH24
SHARP DDRMU0004HE14	DDRMU0004HE17	VH26
SHARP DDRMU0004HE04		VH27
SHARP DDRMU0002HE17		VH28
SHARP DDRMW0005HE02		VH220
SHARP DDRMU0005HE10		VH224
SHARP NSH515		VH322
SHARP NSH516		VH222
SHARP NSH853		VH323
SHARP DDRMU0002HE36		VH225
SHARP DDRMU0002HE39		VH226
SHARP DDRMU0004HE22	DDRMU004HE23 TV/VCR	VH228
SHARP NSH551		VH229
SHARP NSH513		VH230
SHARP NSH852	NSH552	VH321
SONY DSR-35R		VH68
SONY DSR-43R		VH70
SONY 884-854-001		VH71
SONY DZR-27R 8848-54501		VH72
SONY 3-955-048-01		VH360
SONY 1-550-536-11		VH175
SONY 1-550-534-11		VH176
SONY 1-550-694-11		VH177
SONY 8-848-625-01		VH178

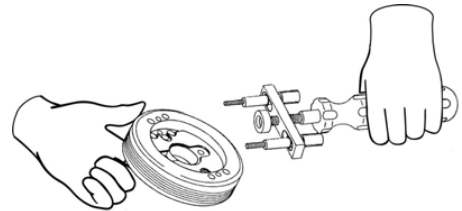

**MORE MODELS  
AVAILABLE SEE:  
<http://www.wes.com.au/>**

## DRUM ASSEMBLIES COMPLETE

Includes Upper-Drum (Video Head) with Lower-Drum & Motor

Description	Code
LG / AKAI DRUM ASSEMBLY 6723R-0101B	VHD0101
LG / AKAI DRUM ASSEMBLY 6723R-0103B	VHD0103
AKAI DRUM ASSEMBLY BV-V9009 A020A	DRM12
JVC DRUM ASSEMBLY HR-D170	DRM170
HITACHI DRUM ASSEMBLY VT128	DRM128
SAMSUNG DRUM 69017-123-710	DRM971
SAMSUNG DRUM 69017-124-042	DRM124
SAMSUNG DRUM 69017-124-059	DRM125
SAMSUNG DRUM 69017-124-061	DRM127

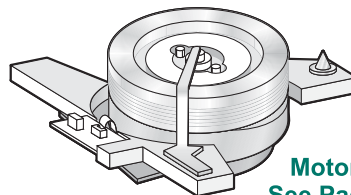

**Motor Only  
See Page 9**

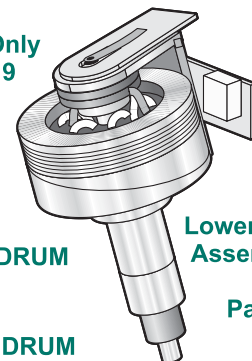

**Lower Drum  
Assemblies  
See  
Page 4-2**

### Upper/Lower Drum Assemblies

Please note that some of the latest heads are only available in this complete form.

If the Upper Drum is available separately, it will be listed as "VH" and share the same suffix number from the substitution list as the "VHD" code number. (But not "DRM").

This is because of new manufacturing and head alignment techniques.

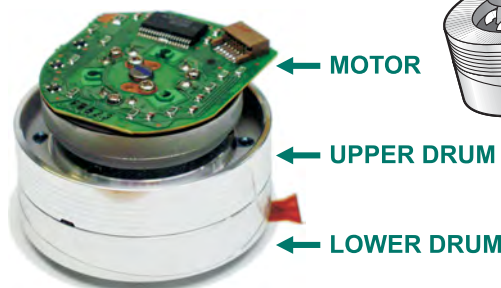





## □ Akai / LG

### AKAI / LG DRUM ASSEMBLIES

VHD Upper & Lower  
Drum assemblies  
With Motor.

**6723R-0101B**

Code  
VHD0101

**6723R-0103B**

Code  
VHD0103

Head only is available.  
See VH Listing.



## □ Servicing Tools and Accessories

### UNIVERSAL HEAD EXTRACTOR TOOL

Hand tool designed for extracting video  
heads without damage to the drum assembly.  
Adjustable for various heads.

Code  
HT800

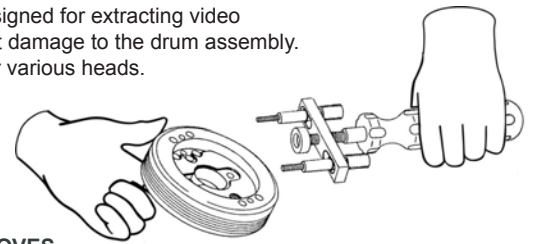

### COTTON GLOVES

Eliminate the need to clean heads after fitting by using  
gloves. Recommended by leading manufacturers.  
Sold in pairs.

Code  
GLV2

## □ Funai

### FUNAI LOWER DRUM ASSEMBLY//\*\*//3

#### NON-SOLDER TYPE

Original Part No 6004-09-01, Chassis  
V-3S

Models MV307,316,445,450,  
VCR417, 9000,  
VGX815, 820,  
VR1900, VX4000

Suit VH142 / 143 (not inc.)

Code FU901

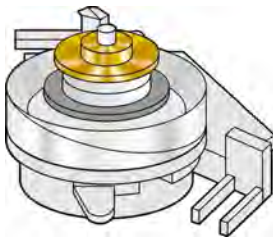

## □ Hitachi

### HITACHI DRUM ASSEMBLY//\*\*//4

Complete UPPER &  
LOWER assembly.  
Suit VT128, etc.

Code  
DRM128

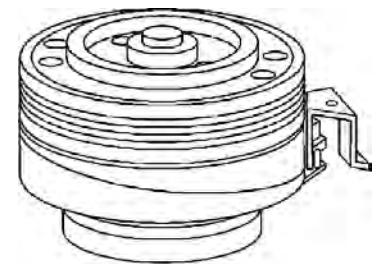

## □ JVC

### JVC COMPLETE DRUM ASSEMBLY//\*\*//5

Upper and lower  
drum assembly  
with motor, etc.  
Suit HR-D170,171, etc.

Code  
DRM170

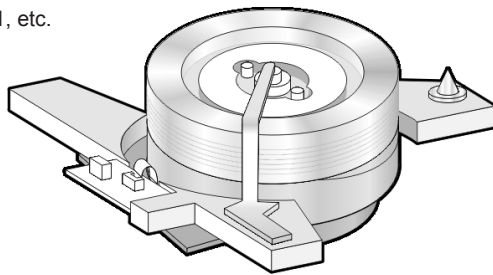

## □ Samsung

### SAMSUNG LOWER DRUM ASSEMBLIES//\*\*//6

#### 69000-370-034 (2HEAD)

Suit	Code
PB970,971,TE90H	DRM970

#### 69000-400-013 (4HEAD)

Suit	Code
VB350	LDR13

#### 69000-291-083 (2HEAD)

Suit	Code
VB306	LDR83

#### 69000-291-084 (4HEAD)

Suit	Code
VB336	LDR84

HEAD SOLD SEPARATELY

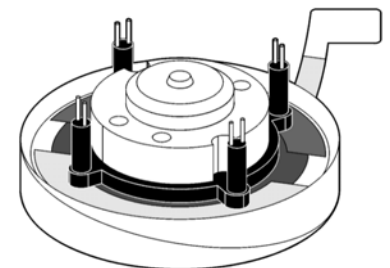

### JVC LOWER DRUM ASSEMBLY//\*\*//7

Lower drum & motor, etc.  
REQUIRES VIDEO HEAD

Suit	Code
HRD580	PDM2138H
HRDX20	PDM2138Y

#### VIDEO HEAD

Optional Upper Drum

Suit	Code
HRDX20	VH216

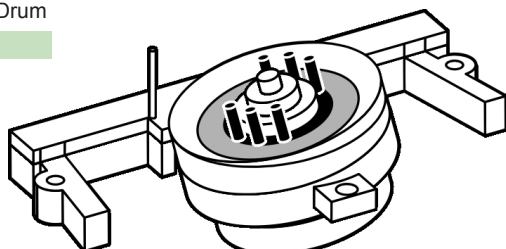

### SAMSUNG DRUM ASSEMBLY//\*\*//8

#### 69017-123-710

Suit	Code
PB970,971,972	DRM971

#### 69020-124-042

Suit	Code
SV30B, AV30BV	DRM124

#### 69020-124-059

Suit	Code
SV80, 81	DRM125

#### 69020-124-061

Suit	Code
SV140	DRM127

INCLUDES VIDEO HEAD

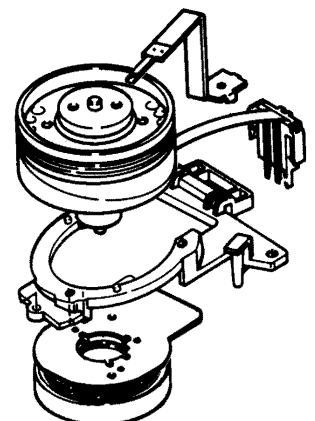







## AC Heads

### AUDIO CONTROL HEADS

#### DAEWOO / DEITRON / TEMPEST / TRACTON / ESC / VIDEO-PRO

Original Part No	Suit	Code
97PA450300	TE970/VCR32/VCR8025	VBR4503
97S8005520	DVR6158D/TE99R/VRD300L	VBR5520

#### FUNAI / PALSONIC / TEAC

Original Part No	Suit	Code
6204-15-06		FU1506
62D62041520	MV3010,30,50, VCR9688	AC1520

#### LG GOLDSTAR

Original Part No	Suit	Code
3041R-0005A	Akai VSJ200, 215, 411, 416, 700, 711, 716 LG AF293, 493, 993, AC250, 450, 950	AC0005
225-402C W903H	LG	AC5402

#### HITACHI

Suit	Code
VTM598, 838	AC4061

#### JVC

Suit	Code
HRJ200,400	PEHE0247
HRD170,171 etc	PU59253
HRD520, etc	PU60617-3

#### JVC ERASE HEAD

Original Part No	Suit	Code
TDK6B50, L491	HRDX20, 22	PU60616
QAH0010-002	HRJ255,455,655,755., Philips VR288,388. 4822-249-10557	AC0002

#### NATIONAL / PANASONIC

Suit	Code
NV300.	VBR0050
NV600,777,788,RTV322	VBR0061
NV-G7,10,12,30 etc. & NV250,280,370 etc. , & RTV301, VR6520.	VBR0070
NV-G7,10,12,30 etc. & NV250,280,370 etc. , & RTV301, VR6520.	VBR0091
NVH70A	VBR0100
NV-G7,10,12,30 etc. & NV250,280,370 etc. & RTV301, VR6520.	VBR0103A
NV730, NV770	VBR0105A
NV-G20, NV-H75	VBR0112
NV-G20, NV-H75	VBR0125
NVL15	VBR0129
NV600,777,788,RTV322	VBR0156
NVF55, NVJ11	VED0160
NVSD10,20,30,NVHD70,100	VED0182
NVH70A	VEH0233
	VEH0237
NV-G7,10,12,30 etc. & NV250,280,370 etc. & RTV301, VR6520.	VEH0247
NVH70A	VEH0248
NV730, NV770	VEH0259
NVSD220, 270, 420, 620, 670	VED0363
NVSD220, 270, 420, 620, 670	VED0412

#### NEC

Original Part No	Suit	Code
79501140, 79501094		AC1140
79501145	N9033,N9034	AC1145
79501153	DX3000,N9052,9053,9530	AC1153
97SA311200	D284,DVK10W,DVK824,MV3080,MV6094, etc.	AC1200
82417PAI	N901, N911	AC2417
16190362	N9072/73/83, 9401/2, 9570	AC3620

#### SAMSUNG

Original Part No	Suit	Code
6526 4606 510	VB627	AC5033
6900 0291 032	VB300, 370, etc.	AC1032
66603-0006-00	SV10,11,12,30,80,140	AC600

#### SHARP

Original Part No	Suit	Code
RH-EDU0031GEZZ	VC381 etc.	DU0031
RH-EDU0040GEZZ		DU0040
RH-EDU0054GEZZ	VC100 etc.	DU0054
RH-EDU0056GEZZ	VC651X etc.	DU0056
RH-EDU0057GEZZ	VC782 etc.	DU0057
RH-EDU0058GEZZ	VCH851 etc.	DU0058
RH-EDU0070GEZZ	VCF18,VCA111,etc..	DU0070
RH-EDU0083GEZZ	VCA36, VCA37, VCA50	DU0083
RH-EDU0085CEZZ	VCA200, VCA460, VCH600, etc.	DU0085
RH-EDU0088GEZZ	VCA220,270,420,470.	DU0088

**MORE MODELS  
AVAILABLE SEE:**  
<http://www.wes.com.au/>

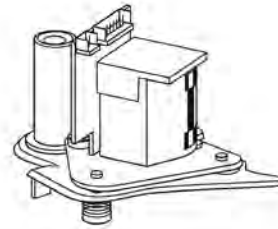

**NOTE.** In some cases the PCB may differ.  
However, the head is interchangeable.

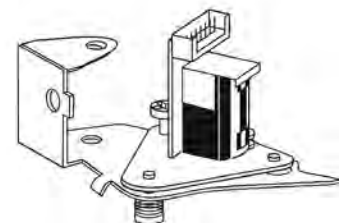
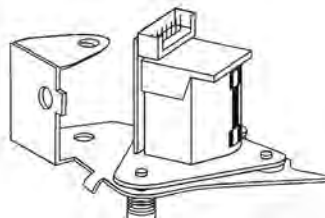
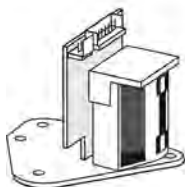
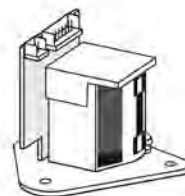
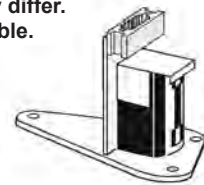

<http://www.wes.com.au/>





## □ Motors

### VIDEO MOTORS



MORE MODELS  
AVAILABLE SEE:  
<http://www.wes.com.au/>

## □ Akai

### AKAI CAPSTAN MOTOR

Original Part No BM-386236J1,  
DFX-67B3VWA1  
Suit VS422,425,  
VS465,756,  
VSF10,12  
Code VM3862

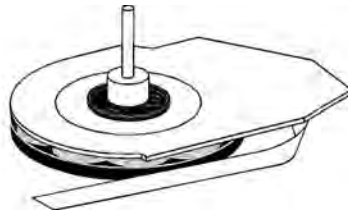

### AKAI LOADING MOTOR

Original Part No BM-348088,  
MMN-5C2RP  
Suit VS1,3,4  
VS6,8,etc.  
Code VM3480

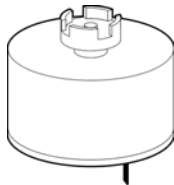

### AKAI PC DRUM MOTOR BLOCK

Original Part No BM-M3223A020A  
Suit VS105,112,  
VS115,116,  
VS165,etc.  
Code VM3223

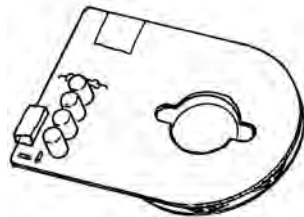

### AKAI PC DRUM MOTOR BLOCK

Original Part No BM-M3224A020A,  
BM-M3224A5010  
Suit VS240  
Code VM3224

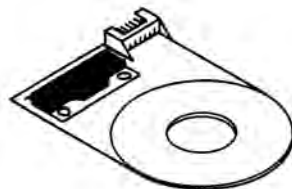

### AKAI DRUM MOTOR BLOCK

Original Part No BM-M3225A501A,  
BM-M3225A020A  
Suit VS35 VS965  
Code VM3225

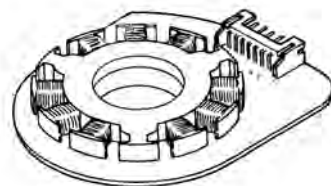

### AKAI DRUM MOTOR BLOCK

Original Part No BM-M3227A5030,  
BM-M3227A020A  
Suit VS465  
Code VM3227

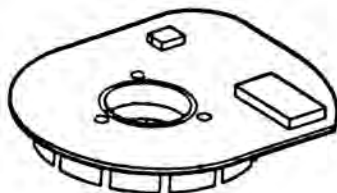

### AKAI CAPSTAN MOTOR

Original Part No BM-373098  
Suit VS35  
Code VM3730

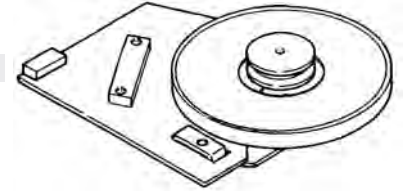

### AKAI MOTOR

Original Part No BM733648J1  
Suit VS66, VS53  
Code VM3648



### AKAI CAPSTAN MOTOR

BM419269N3  
Suit VSG205, 317,  
Code VM9269

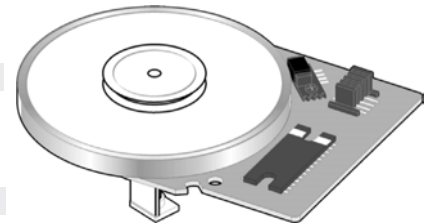

### BM42850N3

Suit VSG445,858,  
Code VM2850

### AKAI DRUM MOTOR

Original Part No 74680RB0004A,  
743K000205-65  
Suit VSG280, 480,  
485, VSJ200,  
416, VJS700,  
716.  
Code VM0004



### AKAI CAPSTAN MOTOR

Original Part No 4680RA0002A,  
B, 4680RA0003A  
Suit VSJ200, 215,  
411, VSJ416,  
700, 711, 716.  
GVC003A,  
VHRVK210,  
VN204, AC250,  
450, 950, AF293,  
493, 993  
Code VM0002

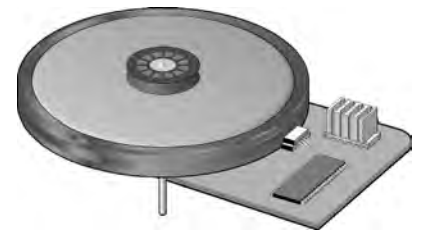

### AKAI DRUM MOTOR

Original Part No BM419324N2,  
BM419324N4,  
SDV-0302A  
Suit VSG705  
VSG735  
Code VM9324

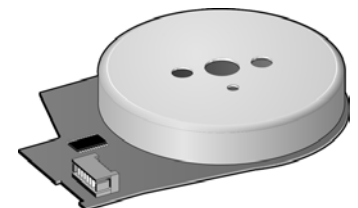

### AKAI LOADING MOTOR

Original Part No BM433593N1  
Suit VSG280, VSG2DPL  
VSG765, 790, 875.  
Code VM3593

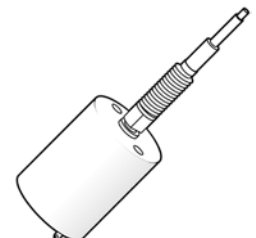





## Daewoo

### DAEWOO CAPSTAN MOTOR

FITS TEMPEST, TRACTON ESC, VIDEO-PRO

Original Part No 97S8102300, Sony BHF-3108C  
 Suit TE970R, VCR32  
 Code VM8025

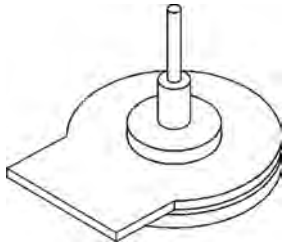

### DAEWOO DRUM MOTOR

Original Part No 97SA398910, Sony U-14C  
 Suit DVR6158D, TE99R...  
 Code VM8910

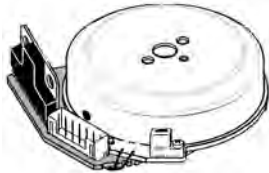

### DAEWOO CAPSTAN MOTOR

Original Part No 97S8102400, Sony BHF-3108B  
 Suit DVR6158D, TE99R, etc.  
 Code VM2400

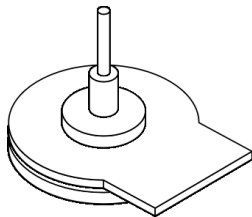

### DAEWOO TEMPEST LOADING MOTOR

Original Part No 97S8102000  
 Suit DVR6158, VCR32, 52, VCR8025, TE970R, 99R...  
 Code VM0244

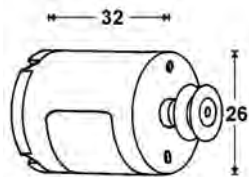

### DAEWOO DRUM MOTOR

FITS TEMPEST, TRACTON, ESC, VIDEO-PRO

Original Part No 97SA393010, Sony U-10A  
 Suit TE970R, VCR32, VCR8025  
 Code VM3010

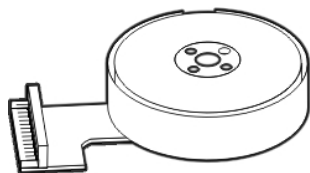

## Goldstar / LG

### GOLDSTAR LG

OEM Mechanism  
 Old: was an NVG mech  
 New: used as mech for other brands like Mitsubishi and more recently Akai...

**SEE LG GOLDSTAR MORE MODELS AVAILABLE SEE:**

<http://www.wes.com.au/>



## Funai / Teac / Palsonic

### FUNAI TEAC PALSONIC CAPSTAN MOTOR

Original Part No 62D60030360  
 Suit MV3010, 3030, 3050, MV4010, 6010, Palsonic VCR9688  
 Code VM0360



### FUNAI TEAC PALSONIC LOADING MOTOR

Original Part No 62D806511301  
 Suit MV3010, 3030, 3050, MV4010, 6010, Palsonic VCR9688  
 Code VM6158

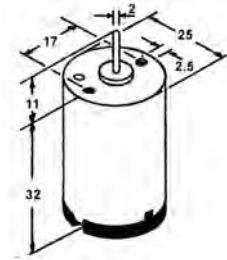

## Hitachi

### HITACHI CAPSTAN MOTOR

Original Part No 5571471, 5571458  
 Suit VT518, etc.  
 Code VM1458

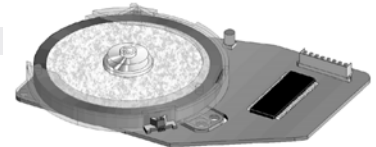

### HITACHI CAPSTAN MOTOR

Original Part No 5578764  
 Suit VT100, 120, VT125, 128, VT130, 135, VT138, etc.

Discontinued.  
 Use VM5579, Change PCB.



### HITACHI CAPSTAN MOTOR

Original Part No 5578014 5577352  
 Suit VT11, 17, VT33, 38, VT39, etc.  
 Code VM5579



### HITACHI CAPSTAN MOTOR

Original Part No GP10123, GP10112  
 Suit VTM428, VTM448  
 Code VM10112





## HITACHI CAPSTAN MOTOR

Original 5571743  
 Part No  
 Suit VTM728, etc.  
 Code VM1743



## HITACHI CAPSTAN MOTOR

Original 5571475  
 Part No  
 Suit VTM598E,  
 VTM838E  
 Code VM1475



## HITACHI MOTOR & MODE SW

Original 7794932  
 Part No  
 Suit VTM757E  
 Code MEC4932

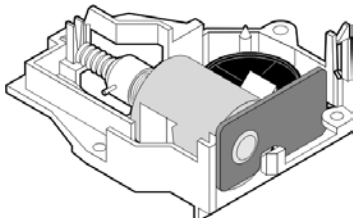

## JVC

### JVC

A primary OEM  
 for older VCR



## JVC LOADING MOTOR

Original PU48854M  
 Part No  
 Suit HR7200,7650,D120,D  
 121,HRD125,140,150,  
 157,160,220,225,250,  
 725,N830,831,832,833  
 ,RV340,350,360,370,V  
 CR1500,& AKAI,etc.  
 Code VM2115

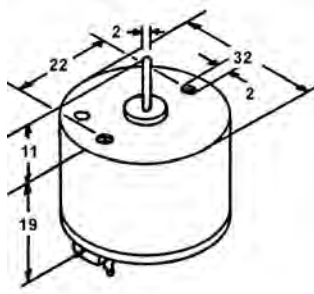

## JVC LOADING MOTOR

Original PQ41996A, PQ41996B,  
 PU60437  
 Part No  
 Suit HRD230, 320,  
 HRD370, 430.  
 Code VM4199

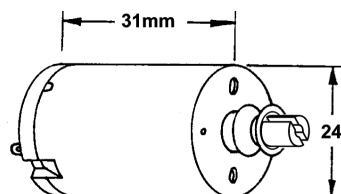

## JVC DRUM MOTOR

PU46414P, PU44619  
 HR3300,3330,36  
 60,HV1000,2000,  
 RV300,Also AKAI,  
 HITACHI,NORMENDE  
 & TELEFUNKEN and  
 some early SHARPs.

Code  
 VM2120

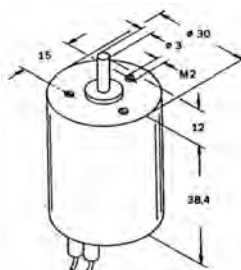

## JVC MOTOR

Original PU55371V  
 Part No  
 Suit HRD110,111,HRD120  
 ,121,225,GE8100,930  
 0,N830,831,833,RV36  
 0,310,etc.  
 Code VM5371

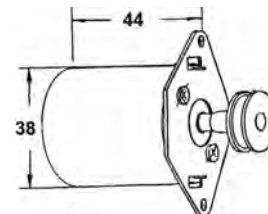

## JVC CAPSTAN MOTOR

Original PU58635V  
 Part No  
 Suit HR-D160, 170, 171,  
 180, 210, 211, 217,  
 227, 230, 310, 320,  
 321, 370, 430, 470,  
 500,etc.  
 Code VM5863

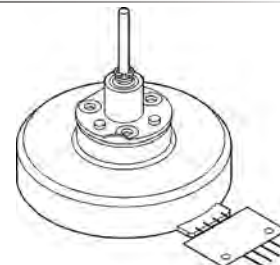

## JVC CAPSTAN MOTOR

Original PU57647V  
 Part No  
 Suit HRD152, 157, 158,  
 HRD565, 546, etc.  
 MV800, VR2925,  
 2930, 2970  
 Code VM5764



## JVC MOTOR

Original PQ40244A-2  
 Part No  
 Suit HRD140 etc.  
 Code VM0244

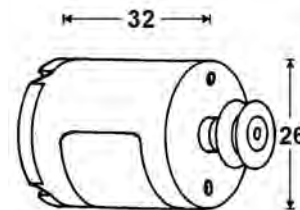

## JVC REEL MOTOR

Original PU58636W  
 Part No  
 Suit HRD170, HRD180,  
 HRD200, HRD530  
 And more  
 Code VM5864

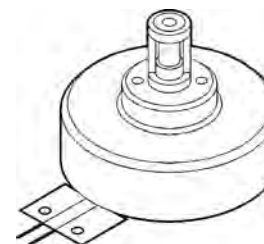

## JVC CAPSTAN MOTOR

Original PU60201V  
 Part No  
 Suit HRD300, HRD337,  
 HRD530, HRS5000E  
 And more  
 Code VM6020

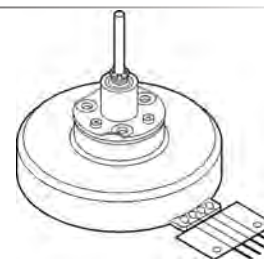

## JVC/PHILIPS CAPSTAN MOTOR

PU61285  
 Suit HRD-X20,22,  
 VR3241,3245.  
 Code VM6128

PU60892-1-5  
 Suit HRD520,600,etc.  
 Code VM6089

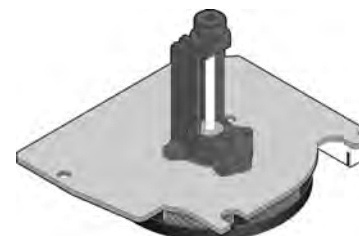



## JVC CAPSTAN

Suit HRD540,910  
Code PU61003

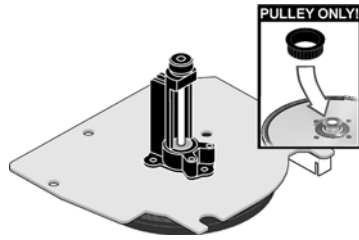

## BELT PULLEY ONLY

Original PTU96031-678C  
Part No  
Code PTU96031

## JVC LOADING MOTOR

Original PQ43676B-5  
Part No  
Suit HRJ200, HRJ400  
Code VM6282



## JVC LOADING MOTOR

Original PQ43676B-5  
Part No  
Suit HRJ200, HRJ400  
Code VM6282

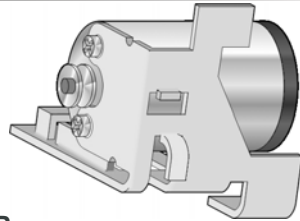

## JVC LOADING MOTOR

Original PU60628-3-2,  
QAR0023-001  
Part No  
Suit HRJ255, 455, HRJ655,  
755.  
Code VM6158

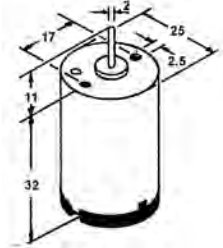

## JVC CAPSTAN MOTOR

Suit HRJ220,  
221, HRJ625, etc.  
Code PU61435-1-6

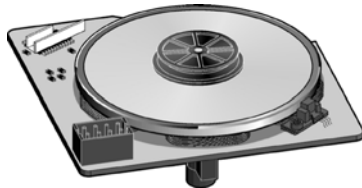

## JVC CAPSTAN MOTOR

Original PU61487-2-5  
Part No  
Suit HRJ435,  
635, HRS9400, ...  
Code PU61487



## JVC / PHILIPS DRUM MOTOR STATOR

Original JVC PDZ0141-1-2,  
Philips 482236210274  
Part No  
Suit HRJ220, 221, 425,  
HRJ435, 625, 635,  
Philips VR255-75, 357-75  
VR555-75, 656-75  
Code PDZ0141

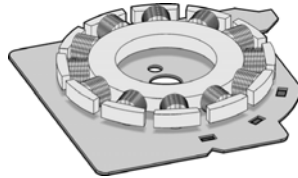

## JVC MECHANISMS WITH MOTOR

Some JVC Motors are available only bundled with their gear assemblies. Please refer to the Idler / Misc listing in this section.

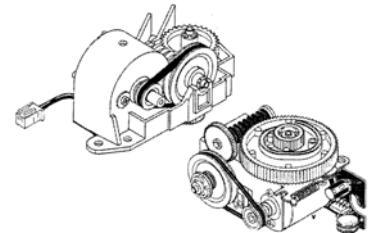

## JVC / PHILIPS DRUM MOTOR STATOR #1

IC JCM5039 (30 pin)

Original PDZ0141-2-2,  
PDZ0181-1-2  
Part No  
Suit HRJ255, 455,  
HRJ655, 155,  
Plus many more!  
Code PDZ0181

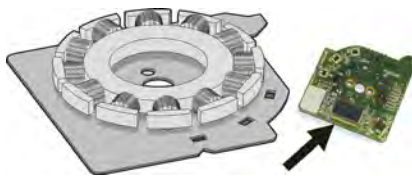

## LG / Goldstar

## LG GOLDSTAR LOADING MOTOR

Original 414-051A  
Part No  
Code VM4140

Also some Mitsubishi

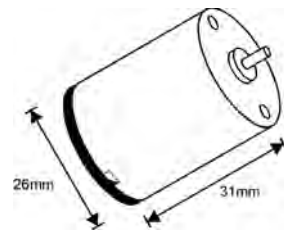

## JVC/PHILIPS DRUM MOTOR STATOR #2

Original QAR0021, 4822-  
249-10296  
Part No  
Suit VR288, 388.  
Code VM0181



## LG GOLDSTAR LOADING MOTOR / BRACKET

Original 4811R0011A  
Part No  
Suit AF293, 493,  
993, AC250, 450,  
950.  
Code VM0011



## JVC/PHILIPS CAPSTAN MOTORS

Original Part No	Suit	Code
QAR0032-003/5	HRJ255, 455, 655, 755.	VM2003
QAR0018-006	VR288, 399, 588, 988.	VM1094







## LG GOLDSTAR CAPSTAN MOTOR

Original Part No 414-102A  
 Suit GHV1290, 1291, GHV1296, 1910, etc.  
 Code VM4102

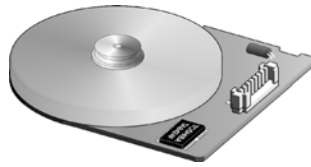

## LG GOLDSTAR CAPSTAN MOTOR

Original Part No 414-108A  
 Suit VCP100, 101, VCP105, 106,  
 Code VM4141



## LG GOLDSTAR MITSUBISHI CAPSTAN MOTOR

Original Part No 414-029A  
 Suit AV61 GHV1232 GHV1240, etc.  
 Code VM4144

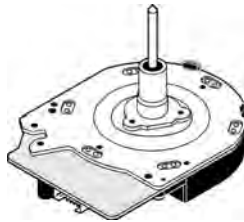

## LG GOLDSTAR CAPSTAN MOTOR (A)

Original Part No 414-120A, GVC017A, CXA8005  
 Suit RA211X  
 Code VM4121

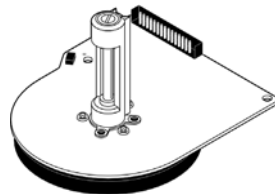

## LG GOLDSTAR CAPSTAN MOTOR (B)

Original Part No 414-120B  
 Suit RG20, RA20, RA21.  
 Code VM4120



Version "B" Differs from "A"

## LG GOLDSTAR MITSUBISHI DRUM MOTOR

Original Part No 414-081A  
 Suit AV63, 64  
 Code VM4108

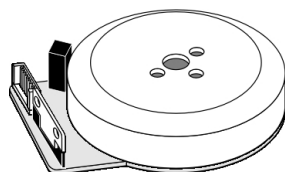

## Mitsubishi

### MITSUBISHI SUPPLY REEL MOTOR

288P028060 or 288P028A60  
 Suit HS303, 304, 320, HS330, 700, etc. AV11, 21, 29, 31, AVT10, 20, 30, TR101, 201...  
 Code VM8060

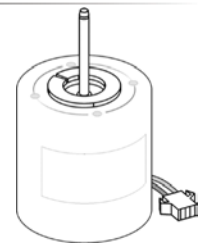

### MITSUBISHI/AWA REEL MOTOR

Original Part No 288PO46010  
 Suit AV11, 21, HS30, 330,  
 Code VM6010

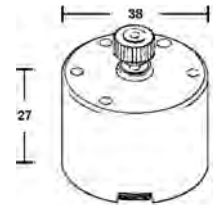

### MITSUBISHI/AWA LOADING

Original Part No 288P06701  
 Suit AV49, 58, 63, AV337, 411, HS337, 411, HSE10-70, and more....  
 Code VM0244

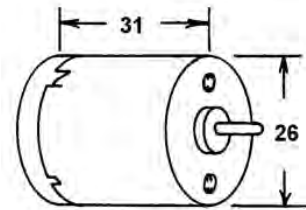

### MITSUBISHI LOADING MOTOR

Suit Many brands and models.  
 Code VM6158

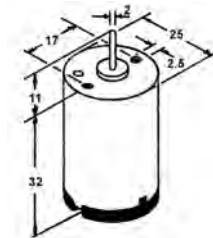

### MITSUBISHI PULLEY

The plastic one is broken, replace it with this brass one. Requires glue, (14-36)

Original Part No 631D581010  
 Suit HSMX Series.  
 Code PLY101

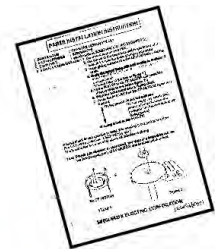

### MITSUBISHI CAPSTAN MOTOR

Original Part No 288P08904  
 Suit HSE17, 27, HSE52, 82.  
 Code VM8904



### MITSUBISHI CAPSTAN MOTOR

Original Part No 288P11701  
 Suit HSM34, HSM380V, HSMX2, 18, HSMX38  
 Code VM1701





## □ NEC

### NEC CAPSTAN MOTOR

Original Part No VM2700  
 Suit VN20, DVR2700, DVR4773  
 Code VM2700



### NEC CAPSTAN MOTOR

Original Part No 61308788-54, 079-V1-5015, 192-9197-006  
 Suit DVR4773, VHR120, 1309, VN30, 32.  
 Code VM5015

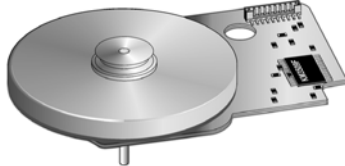

## □ National

### NATIONAL/MITSUBISHI

#### GENERAL PURPOSE LOADING MOTOR

Original Part No 288P04401  
 Suit Many brands and models.  
 Code VM6158

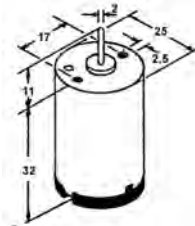

#### LOADING MOTOR

Original Part No VEM0218<br>NV250  
 Suit NV250 NV280 NV450 NV470 NV870  
 Code VM0218

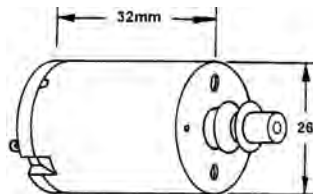

#### NATIONAL REEL MOTOR

Includes sleeve.

Original Part No KFN56FB8A  
 Suit NV777,788  
 Code VM568

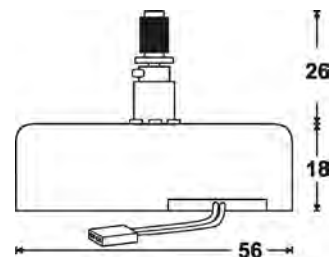

#### Rubber Sleeve only

Code Cost  
 VIT400 \$0.95

#### NATIONAL LOADING MOTOR

Original Part No VEM0242  
 Suit NV-G7 & others.  
 Code VM0242

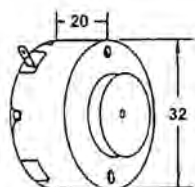

#### NATIONAL LOADING MOTOR

Original Part No VEM0211  
 Suit NV250, 280, 450, 730, 770, 870, etc.  
 Code VM0211

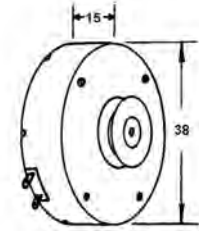

Suit also GOLDSTAR

#### NATIONAL REEL MOTOR

Original Part No VEM0212  
 Suit NV730,770  
 Code VM0212

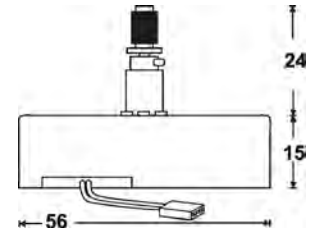

#### Rubber Sleeve only

Code Cost  
 VIT400 \$0.95

#### NATIONAL CAPSTAN MOTOR

Original Part No MAX13V9LP  
 Suit NV600 etc.  
 Code VM1390

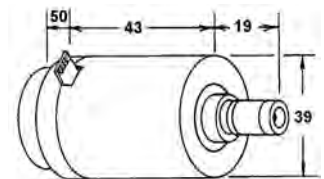

## □ Panasonic

#### PANASONIC STATOR

Suit NVG20, etc.  
 Code VEK2944

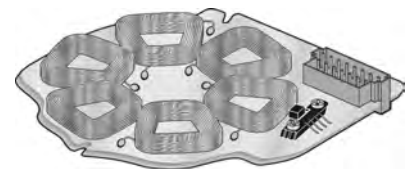

#### PANASONIC STATOR

Suit NV-L20, L25, NV-J1, J35, & More...  
 Code VEK4105



#### PANASONIC CAPSTAN STATOR

Suit NVSD10, NVSD20, NVSD30  
 Code VEK5927

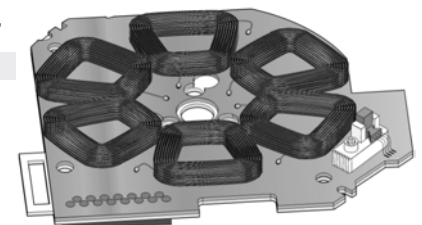

#### PANASONIC LOADING MOTOR

Suit NVSD10, ETC.  
 Equiv. VEM0427  
 Code VM0427

#### BUSH PULLY / WORM

Code  
 VDP1434  
 VDG0866

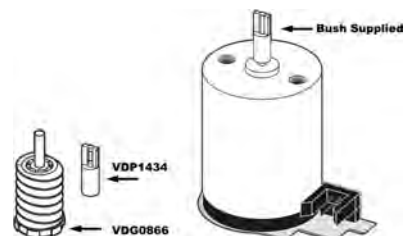





## PANASONIC CAPSTAN BEARING

Suit NVSD10, etc.  
Code VXD0140

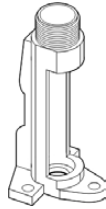

## PANASONIC CAPSTAN MOTOR

Original Part No VEK8024, VEK8239  
Suit NVSD220, 270, NVSD420, NVHD620, 670.  
Code VM8024

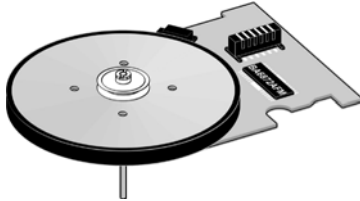

## PANASONIC LOAD MOTOR UNIT

Motor & Mechanism.

Suit NV-SD220, NV-SD270  
Code VEM0604



## Philips

### PHILIPS

Early models  
See Sharp & JVC  
Later models  
See Teac Funai



## Samsung

### SAMSUNG TEMPEST CAPSTAN MOTOR

Original Part No 90002201303, 47690520124, R432274361  
Suit VB520, 900, Akai VS200, TE900H  
Code VM0900

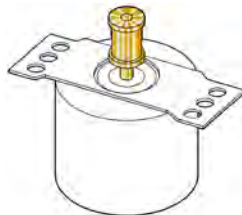

### SAMSUNG CAPSTAN MOTOR

Original Part No 64769-053-330, 64769-052-020  
Suit PB970, 971, PB972, TE90H.  
Code VM3330



## SAMSUNG TEMPEST CAPSTAN MOTOR

Original Part No 64769052094, 64769052095  
Suit PB980, 981, PB982, TE77R.  
Code VM2094



## SAMSUNG TEMPEST DRUM MOTOR

The motor only from above assembly

Original Part No 64769052066  
Suit PB980, 981, PB982, TE77R.  
Code VM1215

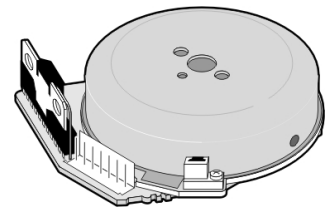

## SAMSUNG CAPSTAN MOTOR

Original Part No 66829-0024-02, 66829-0027-02  
Suit PB30R, 31R, VB30R, 31R, VB300, 370, VB3260.  
Code VM2402



## SAMSUNG CAPSTAN MOTOR

Original Part No 647 6905 2236, 647 6905 2253  
Suit VB1230, 1260, VB1560, 1580, and more...  
Code VM2253



## SAMSUNG CAPSTAN MOTOR

Original Part No 66823-0059-00  
Suit SV10, 11, 12, SV30, 80, 140  
Code VM5900



## SAMSUNG LOADING MOTOR

Includes Gears, Motor, etc.

Original Part No 67179-0068-00  
Code MEC6800

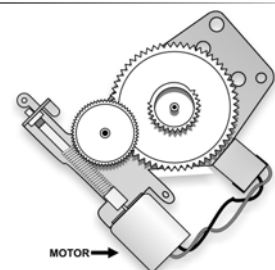



## □ Sanyo

### SANYO MOTOR

Original 613-017-0699  
 Part No  
 Suit VTC6500  
 Code VM2215

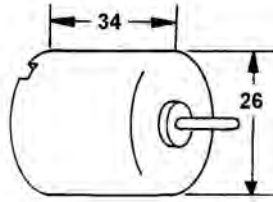

### SANYO REEL MOTOR

Original 4-527V-10800  
 Part No RM11  
 Suit VTC5000,  
 VTC5005,  
 VTC5300,  
 VTC5400  
 Code VM2210

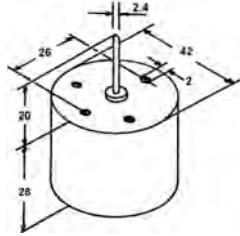

### SANYO LOADING MOTOR

Original 613-021-9527,  
 613-121-9960,  
 3-942-091-01  
 Part No SRT500P,  
 TLS900P, 924P,  
 TLS2000,  
 TLSS2500P  
 Suit  
 Code VM9527

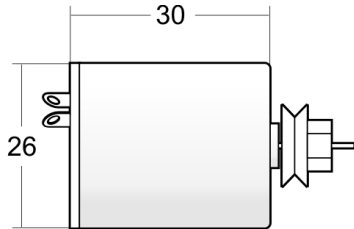

### SANYO CAPSTAN MOTOR

Original 613-089-9156  
 Part No  
 Suit TLS1000  
 Code VM9156

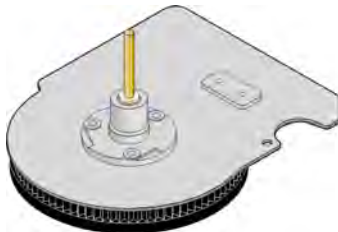

### SANYO CAPSTAN MOTOR

Original 613-130-9425  
 Part No  
 Suit SRT500P,  
 TLS900P,  
 TLS924P,  
 TLS2000,  
 TLSS2500P  
 Code VM9425



### SANYO CAPSTAN MOTOR

Original 645-008-1880  
 Part No  
 Suit VHR310, 590  
 Code VM1880



### SANYO CAPSTAN MOTOR

Original 645-008-1897  
 Part No  
 Suit VHR510, 530,  
 VHR610, 630  
 Code VM5008



### SANYO CAPSTAN STATOR

Original 613 085 7279, 613  
 Part No 132 3520  
 Suit VHR310, 420, etc.  
 Code VM3520

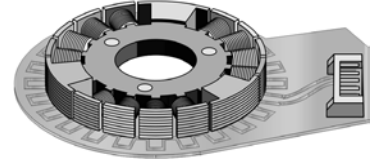

## □ Sharp

### SHARP LOADING MOTOR

Original RMOTM1049GEZZ  
 Part No  
 Suit VCA10X,30,103,  
 105,505,etc...  
 Code VM1049

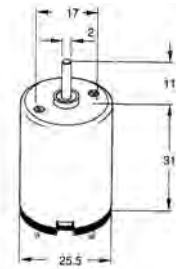

### SHARP CAPSTAN MOTOR

Original RMOTN2051GEZZ  
 Part No  
 Suit VCA62X, VCA63X  
 Code VM2051



### SHARP CAPSTAN MOTOR

Original RMOTP 1029 GEZZ  
 Part No  
 Suit VC381, VC383,  
 VC9100, VC9300  
 Code VM2127

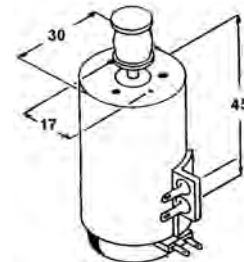

### SHARP MOTOR

Original RMOTM1017GEZZ  
 Part No  
 Suit VC300 series and  
 more....  
 Code VM0244

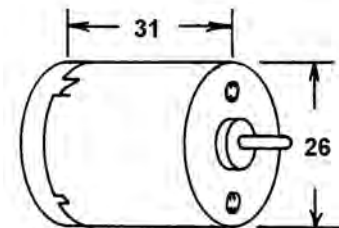

### SHARP CAPSTAN MOTOR

Includes pulley.

Original RMOTP1026GEZZ  
 Part No  
 Suit VC3300 and others.  
 Code VM1026

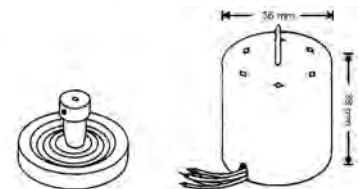



## SHARP CAPSTAN MOTOR

Original Part No RMOTP1059GEZZ  
 MV740, VC100,488, VC581,582,583, VC584,585,5F3, VR6441,6541,6940  
 Code VM1059

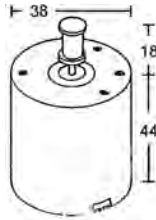

## SHARP REEL MOTOR

Original Part No RMOTV 1010 GEZZ  
 Suit VC481,581, 6441,6641,etc.  
 Code VM1010

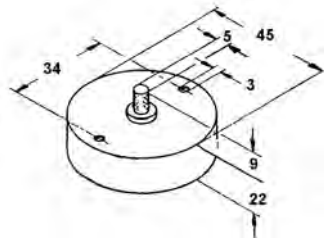

## BRASS PULLEY

Original Part No NPLYV0121GEZZ  
 Code MP121

## SHARP CAPSTAN MOTOR

Original Part No RMOTP1079GEZZ  
 Suit VC600, VC700 series  
 Code VM1079

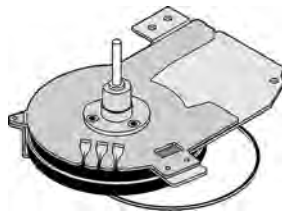

## SHARP CAPSTAN MOTOR

Original Part No RMOTP1066GEZZ  
 Suit VC400 series  
 Code VM1066

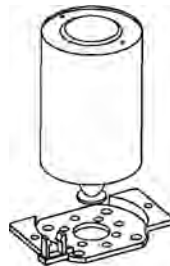

## SHARP DRUM MOTOR

Original Part No RMOTP1077GEZZ  
 Suit VC581,2,3, VC6826V3 and others.  
 Code VM1077



## SHARP DRUM MOTOR

Original Part No RMOTP1092GEZZ, RMOTP1084GEZZ  
 Suit VCA101, 103, VCA502, VCD801, VR6443, etc.  
 Code VM1092



## SHARP DRUM MOTOR

To suit MANY VCA, VCD & VCH series. Philips VR6349.  
 Original Part No RMOTP1096GEZZ  
 Code VM1096

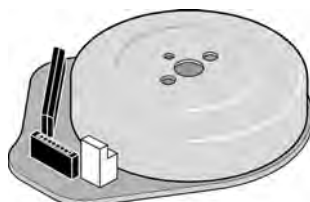

## SHARP CAPSTAN MOTOR

Original Part No RMOTN2001GEZZ, RMOTN2003GEZZ  
 Suit VC772,781,782,785,78 6,787,793,VCA101,etc.  
 Code VM2001

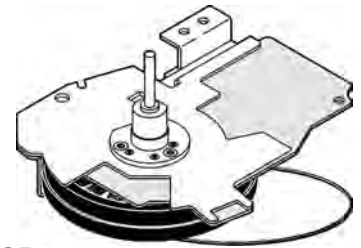

## SHARP CAPSTAN MOTOR

Original Part No RMOTN2012GEZZ, RMOTN2022GEZZ  
 Suit VCA101x  
 Code VM2012

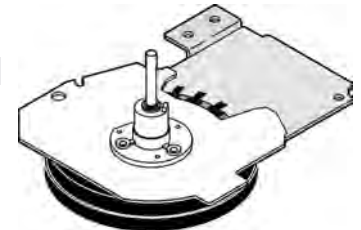

## SHARP CAPSTAN MOTOR

Original Part No RMOTN2020GEZZ  
 Suit VCA101X etc.  
 Code VM2020

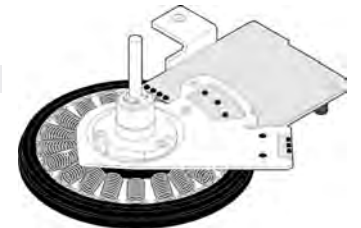

## SHARP CAPSTAN MOTOR

Original Part No RMOTN2055GEZZ  
 Suit VCA220, 270, VCA420, 470.  
 Code VM2055



## SHARP DRUM MOTOR

Original Part No RMOTP1139GEZZ, RMOTP1141GEZZ  
 Suit VCA220, 270, VCA420, 470.  
 Code VM1139

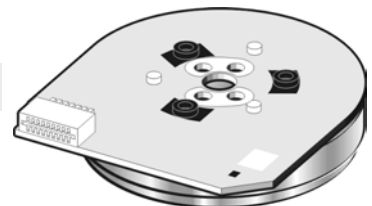

## SHARP LOADING MOTOR

Original Part No RMOTM1078GEZZ  
 Suit VCA220, 270,VCA420, 470.  
 Code VM1078



## SHARP CAPSTAN MOTOR

Original Part No RMOTN2067GEZZ  
 Suit VCA240, 290,VCA490.  
 Code VM2067







## SHARP LOADING MOTOR

Original Part No RMOTM 1029 GEZZ,  
RMOTM 1034 GEZZ  
Suit Many models eg.  
VCA500 series  
Code VM6158

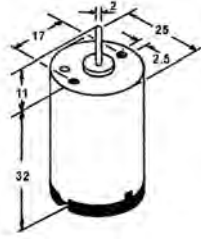

USED IN MANY BRANDS, DAEWOO,  
DEITRON, TEMPEST,...

## SHARP REEL MOTOR

Original Part No RMOTV1007GEZZ  
Suit ORION  
Code VM2122

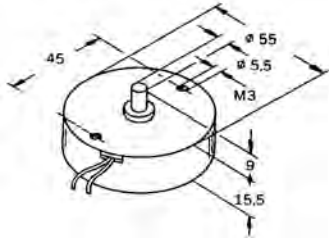

## BRASS PULLEY

Original Part No NPLYV0121GEZZ  
Code MP121

## SHARP REEL MOTOR

Original Part No RMOTV 1008 GEZZ,  
RMOTV 1004 GEZZ  
Suit ORION  
Code VM2121

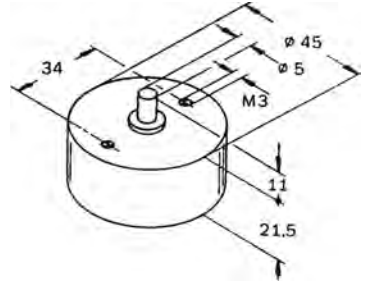

## BRASS PULLEY

Original Part No NPLYV0121GEZZ  
Code MP121

## SHARP CAPSTAN MOTOR

Original Part No RMO TN2052GEZZ  
Suit VCA36X, VCA50X  
and others.  
Code VM2051



## SHARP DRUM MOTOR

Original Part No RMOTP1102GEZZ,  
RMOTP1107GEZZ  
Suit VCA10X etc.  
Code VM1107

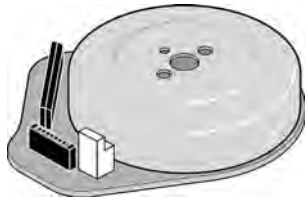

## SHARP DRUM MOTOR

Original Part No RMOTP1116GEZZ  
Suit VCA36,37,41,50,  
VCA53,62,67,72,  
VCA93,94,97,98, and  
more...  
Code VM1116

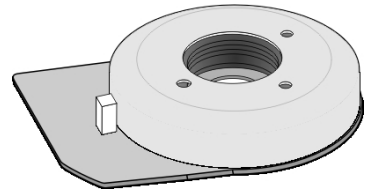

## SHARP CAPSTAN MOTOR

Original Part No RMO TN2010GEZZ  
Suit VCA103X etc.  
Code VM2010

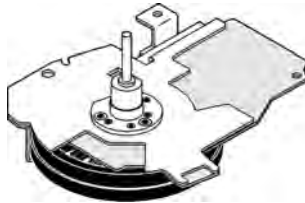

## SHARP LOADING MOTOR

Original Part No RMOTM 1062 GEZZ  
Suit VCA36,37,41,50,53,  
VCA53,62,63,67,72,  
VCH93,94,97,98,  
VCMH83, 93,VT3428,  
5128  
Code VM1062

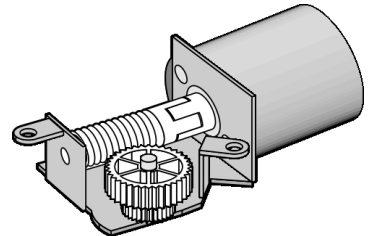

## SHARP CAPSTAN MOTOR

Original Part No RMO TN2019GEZZ  
Suit VCA105X, VC103X,  
VC505X etc.  
Code VM2019

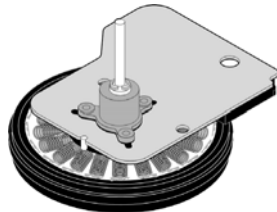

## SHARP VIDEO MOTOR

Original Part No RMO TN2053GEZZ  
Suit Many Models  
Code VM2053



## SHARP CAPSTAN MOTOR

Original Part No RMO TN-2028-GEZZ  
Suit VCA10,30,35,45,  
VCA60,615,H80,  
VR3260,3360,  
VR6349,6449,  
VR6549, etc..  
Code VM2028



## SHARP CAPSTAN PULLEY

The plastic one is broken, replace it with this brass one.  
Requires glue, (14-31)

Suit VCA Series.  
Code PLY101

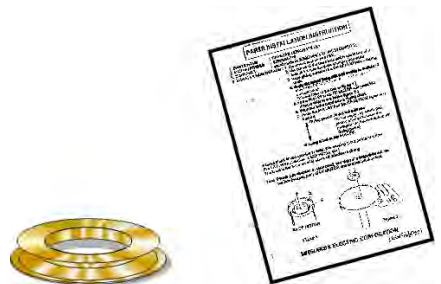

## SHARP CAPSTAN MOTOR

Original Part No RMO TN-2038, 2047,  
2048-GEZZ  
Suit 14VT10X1,  
VCA33,34,38,39,  
VCA48,49,63,64,  
VCH83,84,85,87,  
VR3261,VF22,etc.  
Code VM2038



## SHARP DRUM MOTOR

Original Part No RMOTP-1151-GEZZ  
Suit VCH680, VCH900  
Code VM1151





## □ Sony

### SONY

Very early VHS models were made by Sanyo.



### SONY CAPSTAN MOTOR

Original Part No 8-835-382-01/03  
Suit SLVX50, etc..  
Code VM8203

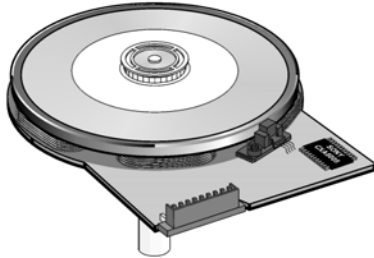

### SONY CAPSTAN MOTOR

Original Part No 3-740-369-02  
Suit SLVX20  
Code VM6902

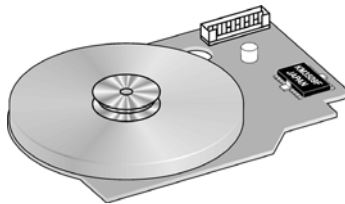

### SONY CAPSTAN MOTOR

Original Part No F2QKB38 394702801, 62D60030354, KV21VM3MT  
Suit SLVKH1, VCR9500, SLVX37, 57, 711  
Code VM9500



### SONY CAPSTAN MOTOR

Original Part No 8-835-489-01/11  
Suit SLVX810  
Code VM8911

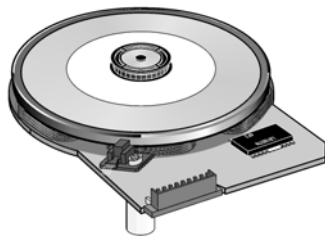

### SONY CAPSTAN MOTOR

Original Part No 8-835-394-11, 8-835-394-01  
Suit SLVX55, SLV777  
Code VM9411

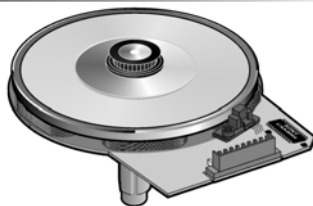

### SONY CAPSTAN MOTOR

Original Part No 1-698-409-14, 1-698-409-11  
Suit SLVX812, SLVX822  
Code VM9140

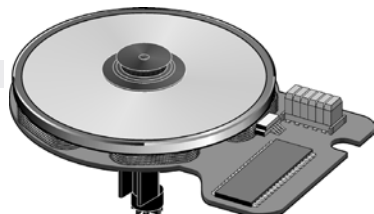

### SONY LOADING MOTOR

Original Part No X-3943-883-1  
Suit SLVX812, SLVX822  
Code VM8831

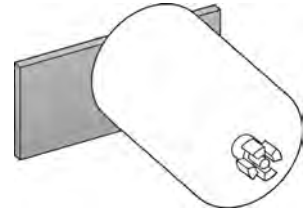

### SONY CAPSTAN BEARING

Suit Above Motors.  
Original Part No X-2625-356-2  
Suit SLVX757, 777, SLVX810, 815, etc..  
Code BR3562

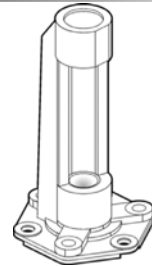

### SONY LOADING MOTOR

Original Part No X-3727-784-1 RF-270RH  
Suit SLVB5511, SLVF10, 11, SLVP33, SLVX810  
Code VM7841



### SONY CAPSTAN MOTOR

Original Part No 169897111, 169897114  
Suit SL-VEZ1, 10, 11, SL-VEZ22, 44, 66, SL-VEZ7, 70, 77.  
Code VM7111



### SONY LOADING MOTOR CAM

Original Part No X39475771  
Suit SL-VEZ1, 10, SL-VEZ7, 70, SL-VKH1, 10, SL-VKH7, 70.  
Code VM5771



### SONY CAM MOTOR

Original Part No X37333021  
Suit SL-VX810 SL-VX811  
Code VM3021



## □ Teac / Philips

### TEAC/PHILIPS CAPSTAN MOTOR

Original Part No 4822-311-10805  
Suit GR560, GV540, MV7, 77, 777, RTV250, 256, 350, RTV456, 725, 785, VR9489/39.  
Code VM8050







# Video Repair Parts

## Video Belts

## Cross Reference

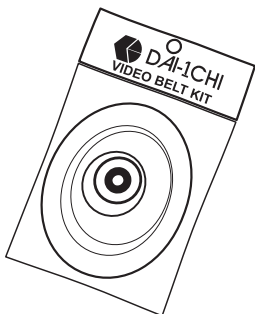
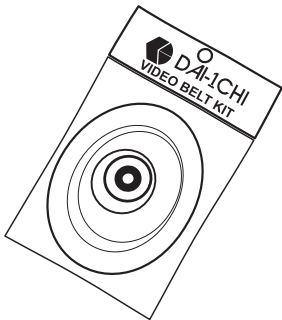
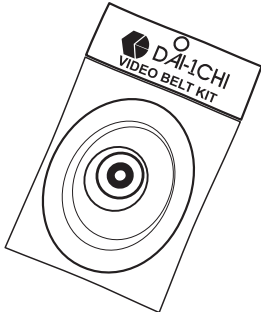
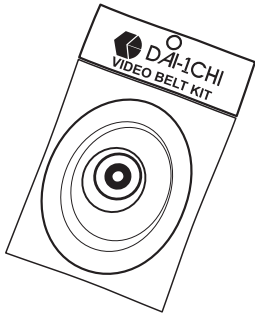
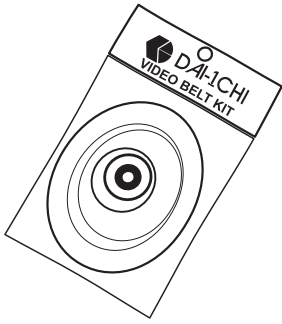

### VIDEO BELT KIT SUBSTITUTION LIST

The following list has been compiled from information received from our customers and is offered as possible suggestions for usage. Please advise us if you find any errors or additions.

*Thank you.*

**PLEASE NOTE THE PRICES  
OF THE KITS ARE ON THE  
PREVIOUS PAGE**

#### Suit Code

#### AKAI

VP77	VBK74
VS1,2,5	VBK3
VS3,4,6,8	VBK55
VS10	VBK4
VS11,12	VBK97
VS15	VBK55
VS22,26,35	VBK91
VS53,55,75	VBK91
VS112,115	VBK71
VS155,165	VBK71
VS200	VBK93
VS240,515	VBK71
VS7100	VBK40
VS7300	VBK1
VS9300,9500	VBK34
VS9700	VBK2
VS9800	VBK34
VSP3	VBK81

#### AIWA

HV-G900BPG	VBK87
------------	-------

#### AMSTRAD

DD9904	VBK129
UF22	VBK120
VCR6000	VBK87

#### AWA/THORN

2H20D, 4H40D	VBK123
AV1,ATV1	VBK37
AV12,14	VBK76
AV47,49	VBK111
AV51,52	VBK76
AV58,59	VBK111
AV61	VBK80
AV62	VBK100
AV337	VBK111
AV400,410,	VBK76
AV411,412,421	VBK111
TR102	VBK76

#### BLAUPUNKT

RTC250,256,350	VBK131
RTV222	VBK 8
RTV301	VBK49
RTV311,434	VBK50
RTV321	VBK48
RTV322	VBK43
RTV328	VBK52
RTV350,356,456	VBK131
RTV424,444	VBK46
RTV716,725,785	VBK131
RTX200	VBK11

#### CASIO

VX2000	VBK88
--------	-------

#### COMPUTAR

CTR3024	VBK118
---------	--------

#### Suit Code

#### DEITRON

DVR6158D	VBK103
----------	--------

#### DISTAR

DS757	VBK97
-------	-------

#### E.S.C.

VCR8025	VBK85
---------	-------

#### FUNAI

VCR4600,4800	VBK110
VCR5200,5400	VBK110
VCR5600,6600	VBK110
VIP5000	VBK110

#### FISHER

FVH-P520	VBK82
FVH-P530	VBK96
FVH-P620	VBK94
FVH-P710,720	VBK94
VBS9000	VBK27

#### HITACHI

VT7E,8E	VBK67
VT11E,17E,19E,20E	VBK68
VT33E,35	VBK72
VT63E,88	VBK68
VT138	VBK108
VT168	VBK108
VT178E	VBK73
VT258	VBK68
VT330	VBK73
VT518	VBK51
VT640,660	VBK73
VT860	VBK73
VT3000	VBK42
VT5000	VBK 5
VT6500,6800	VBK115
VT8000,8050	VBK44
VT8500	VBK65
VT9300	VBK66
VT9500	VBK114
VT-P30	VBK72

#### HMV

HV1000	VBK41
HV2000	VBK53
HV3000	VBK54
HV4000	VBK45
HV7000.	VBK4
HV8000	VBK36
PP24	VBK74

#### G A C

VB910	VBK81
-------	-------

#### G.E.

6900	VBK45
64007300	VBK64
8100	VBK64
8900	VBK36
9300	VBK64

#### GENERAL

VGX930A	VBK102
---------	--------

#### Suit Code

#### GOLDSTAR

GHV1232,1240,1246	VBK80
GHV1296	VBK102
VCP100,105,110,	VBK119
VCP120,126,	VBK119
VCP4100	VBK80

#### GENERAL

VG220A	VBK32
VGX510	VBK99
VGX540	VBK109
VGX625,645	VBK109
VGX715,720	VBK110
VGX815,820A	VBK87

#### JVC

CP5000E	VBK75
CR6000E,6060E	VBK75
HR2200	VBK74
HR2850	VBK45
HR3300,3600	VBK53
HR3330	VBK 7
HR3360,3660	VBK54
HR4100	VBK20
HR7200	VBK45
HR7650,7655	VBK36
HR7600	VBK36
HR7700	VBK 4
HR-D110,111	VBK64
HR-D120,125	VBK64
HR-D140,141,143	VBK78
HR-D150,152,156	VBK78
HR-D157,158,160	VBK78
HR-D170,171,180	VBK77
HR-D190	VBK78
HR-D220,225	VBK64
HR-D250,275	VBK78
HR-D320,370,430	VBK86
HR-D455	VBK78
HR-D520,521,522	VBK116
HR-D540,580	VBK124
HR-D565,566	VBK78
HR-D600,610,620	VBK116
HR-D725,755	VBK78
HR-D790	VBK125
HR-D830	VBK116
HR-DX20,22	VBK116
HR-J200,400	VBK116
HR-J220,221	VBK128
HR-J255,455	VBK133
HR-J600	VBK127
HR-J625,635	VBK128
HR-J655,755	VBK133

#### KAMBROOK

KVP120	VBK119
--------	--------

#### MARANTZ

MV740A	VBK61
--------	-------

See Sharp/Philips

#### MASUDA

M22	VBK80
-----	-------

#### MITSUBISHI

(SEE ALSO AWA)

HS337,338	VBK111
HS347,349	VBK111
HSE11,21,41	VBK118
HSM54,59	VBK118
HSMX1,X2	VBK118
HSMX7	VBK126

#### NORMENDE

VR200	VBK41
-------	-------

<http://www.wes.com.au>



**Suit Code**

**NATIONAL/PANASONIC**

NV-MI,M3	VBK51
NV250,280	VBK50
NV300,333,340	VBK12
NV370	VBK49
NV450,470	VBK50
NV600	VBK48
NV730,770	VBK52
NV750	VBK47
NV777,788	VBK43
NV850	VBK46
NV870	VBK50
NV2000,3000	VBK11
NV7000	VBK10
NV7200,7500	VBK8
NV8170	VBK95
NV8400	VBK35
NV8600,8610,8620	VBK9
NV-G7,9,10,11,12	VBK79
NV-G16,30	VBK79
NV-H70A	VBK79

*THE LATER MODELS USE ONE BELT ONLY eg.*

NVD48,80,  
NV-G20,21,28,  
NV-G33,38,45,48,  
NV-H65,75,NV-L25,  
FS1,90,100, RTV740,...

Code	VDV0169
Cost	3.05

**NEC**

B5	VBK13
DS6000	VBK83
DX1600,3000	VBK83
N830EA,831A,833EA	VBK64
N901,904,911,912	VBK70
N9033,9034,9040	VBK83
N9052,9053	VBK83
N9063,9065,9066	VBK83
N9073,9083,9280	VBK83
N9401,9402	VBK83
N9530,9570,9580	VBK83
N9610,9680	VBK83
PVC754E	VBK63
VCP1	VBK83
VCR5000	VBK64
VH81,91	VBK105
VN23,26,64	VBK123
VN30,32,32	VBK105
VN35,70,71	VBK105

**ORION**

Some units may have different mech's for the same model No. The following is a general guide for the most likely "VBK" to suit.

NATIONAL MECH. TYPES eg.

VH2A MK11	VBK11
-----------	-------

SHARP MECH. TYPES eg.

VH3C, VN2B	VBK39
------------	-------

ORION MECH. TYPES eg.

2B	VBK84
RVP-114	VBK121
VC10P	VBK117
VCP	VBK117
VCRLS,VDLJ,VLBK	VBK130

**PALSONIC**

VCR5000	VBK99
VCR6000	VBK88
VCR7000	VBK100
VCR8000	VBK102
VCR9000	VBK87
VCR9500	VBK122

**Suit Code**

**PIONEER**

VH-780D	VBK83
---------	-------

**PANASONIC**

SEE NATIONAL

**PHILIPS**

VR107,110	VBK132
VR155,255,455	VBK128
VR210,275,299	VBK132
VR256	VBK128
VR257,357,357,399	VBK132
VR401,501,502	VBK39
VR456,656	VBK128
VR457,499,610,620	VBK132
VR555,655,755	VBK128
VR601,701,901	VBK39
VR656	VBK128
VR757,799,810	VBK132
VR820,857,899	VBK132
VR856	VBK128
VR3360	VBK102
VR3442	VBK116
VR6440,6540	VBK61
VR6441	VBK62
VR6442,6443	VBK69
VR6448,6475	VBK102
VR6520	VBK69
VR6540	VBK61
VR6542,6543	VBK69
VR6548,6549	VBK102
VR6743	VBK69
VR6541,6575,6937	VBK62
VR6640,6740,6940,6840	VBK61
VR9489	VBK131

**PRESIDENT**

PV300,500	VBK117
-----------	--------

**PYE**

VRS012,022	VBK39
VRD100	VBK107
VRD300	VBK103

**RANK**

RV300	VBK41
RV310	VBK7
RV320	VBK54
RV330	VBK4
RV340	VBK45
RV350	VBK36
RV360,370,380	VBK64
VP100	VBK74

**SAMSUNG**

VB617,617C	VBK98
VB627,629	VBK98
VB711	VBK97
VB711A	VBK107
VB750	VBK107
VB900A,910	VBK81
VB970,971,972	VBK97
VB2215P	VBK81
VB8220	VBK107
PB981R	VBK107

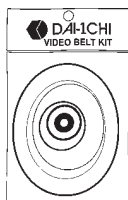

**Suit Code**

**SANYO**

VHR120	VBK105
VHR1100,1300	VBK89
VHR1500	VBK89
VHR2500	VBK104
VHR2700	VBK92
VHR3100,3500	VBK90
VHR3700	VBK90
VHR4100,5100	VBK105
VHR5300,5700	VBK105
VHR7100,7200	VBK105
VHR7500,7900	VBK105
VHR-D500,D700	VBK90
VHR-D4400,4600	VBK105
VHR-D4800,4890	VBK105
VHR-D5810	VBK105
VHR-S-700	VBK106
M10,M20N,M50,NX10	VBK59
VTC5000,5005	VBK58
VTCS300,5400	VBK57
VTCS500	VBK27
VTCS6500	VBK60
VTC9300,9500	VBK.6

**SHARP**

VCA10,30,35	VBK102
VCA45,60	VBK102
VCA101,103	VBK69
VCA105,111,115	VBK102
VCA125,505,615	VBK102
VCA502	VBK69
VCA850	VBK102
VCD801,855	VBK69
VC200	VBK69
VC220N	VBK26
VC381,383,386	VBK39
VC387	VBK24
VC388,390	VBK39
VC481,482,483	VBK61
VC486,488	VBK61
VC500	VBK69
VC581,582	VBK62
VC583,584,585	VBK62
VC6V3,6F3	VBK69
VC651,652,682,685	VBK69
VC700,779,793,781	VBK69
VC782,785,787	VBK69
VC2300K	VBK23
VC3300	VBK25
VC6000	VBK19
VC6300,6500	VBK18
VC7000,7100,7300	VBK17
VC7500	VBK19
VC7650	VBK30
VC7700,7750,7800	VBK17
VC8000,8110,8300	VBK56
VC8482	VBK61
VC9100,9300,9700	VBK39
VCH851X	VBK69
VCT310,510	VBK102
MANY LATE MODELS	VBK102
VCA,VCH,etc	VBK102

**SONY**

MHCU800	VBK134
SLC5E	VBK14
SLC6E	VBK28
SLC7E, SLT7E	VBK14
SLT9ME	VBK22
SL5400,5600,5800	VBK31
SL8000,8080	VBK13
SL8500	VBK13
SLVX10PS,20PS	VBK105
SLVX25PS	VBK105
SLVX37,X57	VBK122

**TANDY**

2B	VBK84
----	-------

**Suit Code**

**TEAC**

MV306,307,308,330P	VBK87
MV314,315	VBK120
MV3410,4810	VBK120
MV400,430	VBK88
MV435,440	VBK88
MV445,450,616	VBK87
MV7,77,777	VBK131
MV1400,1414TV	VBK88
MV1480	VBK87
MV2020TV	VBK88

**TELEFUNKEN**

VR200	VBK41
VR400	VBK54
VR440	VBK41
VR449	VBK54
VR500	VBK54
VR540	VBK4

**TEMPEST**

TE77R	VBK107
TE90H	VBK97
TE99R	VBK103
TE900A	VBK81
TE970	VBK85

**TITAN**

VCR1500	VBK45
VCR1600	VBK64

**TRACKTON**

VCR-32	VBK85
VCR-417TR	VBK87

**TOSHIBA**

V31,33	VBK21
V55,57	VBK64
V63	VBK78
V71,73,74,75	VBK101
V81,83,84,85	VBK101
V93	VBK112
V500	VBK113
V5310T,5310C	VBK33
V5250,5280	VBK15
V5470,5475,7540	VBK29
V8600,8700	VBK16
V9600	VBK32

**VIDEOSTAR**

SOME MODELS	VBK45
-------------	-------

See JVC

**VIDEO-PRO**

VCR8025	VBK85
---------	-------

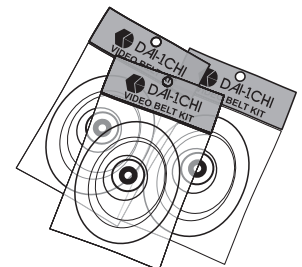

**MORE MODELS AVAILABLE SEE:**

<http://www.wes.com.au/>



# Video Repair Parts

## □ Belt Kits

### VIDEO BELT KITS

Code number and cost listing. Primary models listed only, due to space. For other models, see Cross-Reference Pages.

Suit	Code
AKAI VS7300	VBK1
AKAI VS9700	VBK2
AKAI VS2E/VS5E	VBK3
AKAI VS10, JVC HR7700	VBK4
HITACHI VT5000E	VBK5
SANYO 9300/9500	VBK6
JVC HR3330	VBK7
NATIONAL NV7200EN	VBK8
NATIONAL NV8600/NV8620	VBK9
NATIONAL NV7000	VBK10
NATIONAL NV2000	VBK11
NATIONAL NV300/NV340	VBK12
SONY SL8000/SL8080	VBK13
SONY C5E/C7E/T7E/T9E	VBK14
TOSHIBA V5250/V5280	VBK15
TOSHIBA V8600	VBK16
SHARP VC7300	VBK17
SHARP VC6300	VBK18
SHARP VC6000	VBK19
JVC HR4100	VBK20
TOSHIBA V31/V33	VBK21
SONY SLT9ME	VBK22
SHARP VC2300K	VBK23
SHARP VC387	VBK24
SHARP VC3300	VBK25
SHARP VC220N	VBK26
SANYO VTC5500	VBK27
SONY SLC6E	VBK28
TOSHIBA V5470/V7540	VBK29
SHARP 7650	VBK30
SONY SL5400/SL5600	VBK31
TOSHIBA V5310C/V5310T	VBK33
AKAI 9300/9500/9800	VBK34
NATIONAL NV8400	VBK35
RANK RV350, HMV8000	VBK36
AWA ATVI ATI	VBK37
SHARP 300 & 9000 SERIES	VBK39
AKAI VS7100	VBK40
HMV1000-RANK RV300	VBK41
HITACHI 3000	VBK42
NATIONAL NV777	VBK43
HITACHI 8000/8050	VBK44
JVC HR2650/HR7200	VBK45
NATIONAL NV850	VBK46
NATIONAL NV750	VBK47
NATIONAL NV600	VBK48
NATIONAL NV370	VBK49
NATIONAL NV470	VBK50
NATIONAL NV-M1	VBK51
NATIONAL NV730/770	VBK52
JVC HR3300	VBK53
JVC HR3660	VBK54
AKAI VS3/VS4	VBK55
SHARP VC8300	VBK56
SANYO VTC5300	VBK57
SANYO VTC5000	VBK58
SANYO M10/M20/NX10	VBK59
SANYO VTC6500	VBK60
SHARP VC400 SERIES	VBK61
SHARP VC581, 582, 583 etc	VBK62
NEC PVC754E	VBK63
JVC HR-D110/D120/D225	VBK64
HITACHI VT8500	VBK65
HITACHI VT 9300	VBK66
HITACHI VT7E, VT8E	VBK67
HITACHI VT19E/20E/63E/88	VBK68
SHARP 600 & 700 SERIES	VBK69
NEC 901A, 911A	VBK70

Suit	Code
AKAI VS112, 115	VBK71
HITACHI VT33E	VBK72
HITACHI VT640, 660, 860	VBK73
JVC 2200, AKAI VP77	VBK74
JVC CR 5000E, 6000E, 6060E	VBK75
AWA AV12, AV14	VBK76
JVC HRD170, 370	VBK77
JVC HRD140 etc	VBK78
NATIONAL NVG7, 9, 16	VBK79
GOLDSTAR VARIOUS	VBK80
AKAI/SAMSUNG/TEMPEST 900	VBK81
FISHER FVH-520	VBK82
NEC N9530A	VBK83
ORION VH2B	VBK84
SAMSUNG and equivalents	VBK85
JVC HR-D430EA	VBK86
TEAC MV330P, 450, 445	VBK87
TEAC MV400, 430, 435 etc	VBK88
SANYO VHR-1300	VBK89
SANYO VHR-3100	VBK90
AKAI VS22	VBK91
SANYO VHR-2700	VBK92
AKAI VS200	VBK93
FISHER FVHP620, 710, 720	VBK94
NATIONAL NV8170	VBK95
FISHER FVH-P530	VBK96
TEMPEST TE90H	VBK97
SAMSUNG VB617, etc	VBK98
PALSONIC VCR5000	VBK99
PALSONIC VCR7000	VBK100
TOSHIBA V71, 73 etc	VBK101
SHARP VC-A105	VBK102
TEMPEST TE99R	VBK103
SANYO VHR-2500	VBK104
SANYO VHR-4100	VBK105
SANYO VHR-S700	VBK106
TEMPEST TE77R, PB980R	VBK107
HITACHI VT138	VBK108
GENERAL VGX540/625/645	VBK109
GENERAL, FUNAI	VBK110
AWA, MITSUBISHI	VBK111
TOSHIBA V93	VBK112
TOSHIBA V500	VBK113
HITACHI VT9500	VBK114
HITACHI VT6500, 6800	VBK115
JVC HRD520, 522, 600	VBK116
PRESIDENT PV300, PV500	VBK117
MITSUBISHI HSE11, MX1, 2	VBK118
GOLDSTAR KAMBROOK	VBK119
TEAC MV314, 315	VBK120
ORION RVP-114	VBK121
SONY SLVX37	VBK122
NEC VN23, 26, 64 & AWA	VBK123
JVC HRD540 / 580	VBK124
JVC HRD790	VBK125
MITSUBISHI HSMX7	VBK126
JVC HRJ600	VBK127
JVC HRJ220, 221, 625	VBK128
AMSTRAD DD9904	VBK129
ORION VCRLS, VDLJ, VLBK	VBK130
PHILIPS VR9489-39	VBK131
PHILIPS VR155 TO VR755	VBK132
JVC LP30005-003, -005	VBK133
SONY MHCU-800	VBK134

10 KITS ASSORTED LESS 10%  
 50 KITS ASSORTED LESS 20%  
 100 KITS ASSORTED LESS 25%

MOST VCR USE ONLY ONE BELT?...  
 If only one belt! See following pages.



**MORE MODELS AVAILABLE SEE:**

<http://www.wes.com.au/>



## Video Belts & Idler Tyres

### AKAI

Original Part No	Suit	Size	Code
	VS1,2,3,4,5,8	77x1.8mm	BLT7800
MB387289J	VS12,F10		BLT3872
MB364011	VS112,115, VS165,etc.		BLT4011
MB420053N	VSG mech.		BLT4200
BM433627N	VSG Mech	72x2x2mm	BLT3627

### JVC

Original Part No	Suit	Equiv.	Code
	HRD170,180,370,400, HRD530, HRS5000, 5500.		PQM30003-19
	HRD160,200,230, HRD400,530, S5000, etc.		PQM30003-20
PU48941-2	HR7200,etc.	PU50350	BLT4894
	HR-D540, 580.		PU61006

### NEC/DAEWOO

#### CAPSTAN BELT

Original Part No	79TD 3675
Suit	NEC VN23, VN26, AWA 2H20D,4H40D, and others.
Code	BLT3675

#### LOADING BELT

Original Part No	97S5500100, 79TD4460
Suit	VN23,26, AWA 2H20D,4H40D,
Code	BLT4460

#### LOADING BELT

Original Part No	16629251
Suit	N901,904,911,etc
Code	BLT9251

#### REEL BELT

Original Part No	97S5501800
Suit	VN20
Code	BLT1800

#### REEL BELT

Original Part No	97S 550 2300, 79TD 3940
Suit	VN22, VN25, NEC, AWA, and others.
Code	BLT3940

#### REEL BELT

Original Part No	97S 550 0400
Suit	D284G, D884G, DVK10W, 224D, DVK424D, 824D4, MV3080, 6080.
Code	BLT5500

### PANASONIC/NATIONAL

Code	VDV0074
Code	VDV0122
Code	VDV0135
Code	VDV0138
Code	VDV0148
Code	VDV0149
Code	VDV0151
Code	VDV0152
Code	VDV0153
Code	VDV0169
Code	VDV0235
Code	VDV0382



### SANYO

TYRE ONLY, to fit flywheel capstan.

Suit	VTC9300, 9500., 143-0-521T-01502
Code	FCT9300

#### REEL BELT

Original Part No	Code
VTC5000,5005,6500, M10,M20, NX10, 143-2- 564T-03200	BLT3200
VHR510,530,590, VHR610,630,650., 613- 151-9039	BLT9039

### MITSUBISHI

Suit	AWA ATV10,AV11, THORN TR101
Original Part No	521D03301
Code	BLT3301

#### LOAD BELT

HS621,640,7424.	
Original Part No	Code
521D09601	BLT9601

#### REEL BELT

Original Part No	Code
521D097010	BLT9701

### LG GOLDSTAR

Original Part No	4400R0005A
Suit	AF293, 493, 993, AC250, 450, 950, VSJ200, 215, 411, VSJ700, 711, 716,
Code	BLT0005

### PANASONIC GEAR KIT

Kit combines VXP0767 VDV0159 and washers.

Code	VXP0917K
------	----------

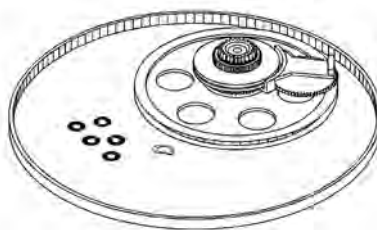

### SAMSUNG

Original Part No	Suit	Code
65274-603-210	VB1230, etc. PB991, etc. VX & VR,...	VDV0149
65274-603-910	VB300, 306, 320, 336	BLT4603
61794-0009-00	SV10, 11, 12, 30, 80, 140	BLT6009

### SHARP

#### MAIN BELT

Original Part No	NBLTK0067AJ00	Suit	VCA220, 270, 420, 470
Code	BLT0067		

#### CAMCORDER BELT

Original Part No	NBLTK0054GEOO
Code	BLT0054

#### REEL BELT

Suit	VCA36,37,41,50,53,62, VCA67,93,94,97,98,...
Code	BLT0065

### SONY

#### SYNCHRO BELT

Original Part No	Suit	Code
3-679-119-11	SLC30,32,33, SLC34,35,40.	BLT1911
3-977-510-01	SLVKH7,9	BLT1001

#### TOOTHED BELT

Original Part No	Suit	Code
3-736-013-01	SLV215,353,757, SLVX30,35,50, SLVX810,etc.	BLT1301
3-958-361-01	SLVX812, 822.	BLT6101

### TEAC PALSONIC

Original Part No	62D80650920
Suit	MV3010, 3030, 3050, MV4010, 6010, Palsonic VCR9688
Code	69X2

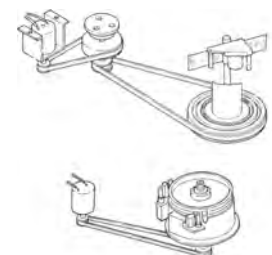





# Video Repair Parts

## Idler Tyres

### VIDEO TYRES & BELTS

Part numbers quoted are original manufacturers' part numbers for the complete assembly. Tyres only are supplied. When ordering please quote our VIT number only or you may receive the whole assembly! Many units are identical internally so you may find these tyres will substitute with other part numbers, other brands, etc.

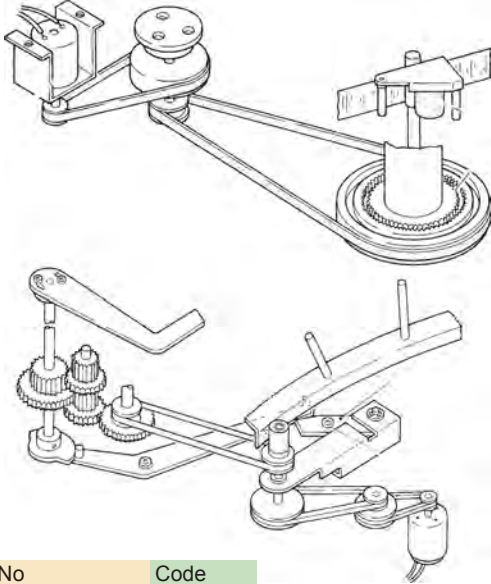

### AKAI TYRES

Original Part No	Code
BV321761 TYRE	VIT12
BV321762 TYRE	VIT16
BV321979 TYRE	VIT20
BV327815L T/UP IDLER	VIT24
BV327815S T/UP IDLER.	VIT28
MI327773 FF/REW IDLER	VIT32
PU42164 TYRE	VIT34
PU42165-2 T/UP IDLER	VIT35
BL-B353110 TYRE	VIT455
PU44917 TYRE	VIT36
PU44918-2 REW IDLER	VIT40
PU46381 UNLOAD ASS	VIT44
PU48907A T/UP DISK	VIT48
PU48907B SUPPLY DISK	VIT52
PU48967A REEL IDLER	VIT56
MZ364046J1 TYRE	VIT60
65153600011 IDLER TYRE	VIT90

### HITACHI TYRES

Original Part No	Code
6866971 TYRE	VIT80
6412654 TYRE	VIT84
6413114 TYRE	VIT88
6413144 TYRE	VIT92
6413202 TYRE	VIT96
6413633 TYRE	VIT100
6414221 TYRE	VIT104
6861471 TYRE	VIT108
6861482 TYRE	VIT112
6861505 TYRE	VIT116
6875386 TYRE	VIT120
6875371 TYRE	VIT124

### JVC TYRES

Original Part No	Code
PU44918 T/UP DISK	VIT200
PU44918-4 F/F IDLER	VIT204
PU48811D, PU48806 IDLER.	VIT206
PU48907C T/UP DISK	VIT208
PU48907D SUPPLY DISK	VIT212
PU48907E T/U DISK	VIT214
PU48967B REEL IDLER	VIT216
PU49281 REWIND IDLER	VIT220
PU49283 PLAY IDLER.	VIT224
PU51402A T/UP IDLER	VIT228
PU55373 T/UP CLUTCH.	VIT232
PU55374-3-8 REEL TYRE	VIT236
PU58645-1-4 TYRE	VIT240

### MITSUBISHI

Original Part No	Code
521D097010 REEL	BLT9701
521D96010 LOAD.	BLT9601

### NEC

Original Part No	Code
16172931 IDLER	VIT450
16178173 25.5x30.5x3.5	VIT454
16178173 26.5x33x3.5	VIT455

### PANASONIC TYRES

Original Part No	Code
VXA1491 FF/REW IDLER	VIT280
VXP0242 REWIND IDLER	VIT300
VXP0243, VXP0599 IDLER	VIT304
VXP0245 F/F IDLER	VIT308
VXP0292 REWIND IDLER	VIT312
VXP0329 FF/REW IDLER	VIT316
VXP0331 PLAY IDLER.	VIT320
VXP0343 PLAY IDLER.	VIT324
VXP0344 FF/REW IDLER	VIT328
VXP0401 FF/REW IDLER	VIT332
VXP0433 PLAY IDLER.	VIT336
VXP0463 FF/REW IDLER	VIT340
VXP0488 PLAY IDLER.	VIT344
VXP0515 FF/REW IDLER	VIT348
VXP0521 IDLER 24X30X3	VIT352
VXP0521 IDLER 23X30X3	VIT353
VXP0581 FF/REW IDLER	VIT356
VXL0404 IDLER UNIT	VIT380
VXL-0997 MOTOR TYRE	VIT390
MOTOR SLV NV730,777,788	VIT400

### SANYO TYRES

Original Part No	Code
143-0-551T-01400 REW IDLR	VIT500
143-0-547T-00200 FF IDLR	VIT502
143-0-551T-01600 REW IDLR	VIT504
143-0-661T-03800 LOAD RLR	VIT508
143-0-662T 01201 REEL DR Also known as 143-0-741T-20001	VIT512
143-0-741T-11101 FWD RLR	VIT516
143-0-4104-0010 TYRE	VIT520
143-0-4104-0020 TYRE	VIT530

### SHARP TYRES

Original Part No	Code
NDAIV1007GEZZ SPINDLE	VIT604
NIDL0005GEZZ IDLER	VIT608
NIDL0006GEZZ IDLER.	VIT612
MLEVF0027GEZZ F/F IDLER	VIT614
NIDR-0004GEZZ REW IDLER	VIT616
NBLTK0054GEOO Camcorder	BLT0054
NPLYV0014GEZZ IDLER BLOCK	VIT620
NPLYV0041GEZZ PULLEY	VIT624
NPLYV0051GEZZ PULLEY	VIT628
NPLYV0107GEZZ PULLEY and	VIT632
NPLYV0111GEZZ PULLEY	

### SONY

Original Part No	Code
X-3653-310-0	VIT700
X-3653-315-0	VIT704
X-3659-324-0	VIT708
X-3671-053-0	VIT712
X-3671-015-0	VIT716
A-6706-348B	VIT720

### SAMSUNG-TEMPEST

Original Part No	Code
65153600011/100 IDLER	VIT90
5253-701-1105 IDLER	VIT750

### TOSHIBA

Original Part No	Code
70316057	VIT804
70353048 PAUSE LEVER TYRE	VIT808

### AWA-THORN

Original Part No	Code
641B10101/2 IDLER	VIT65
522P002101 IDLER	VIT70





## Pinch Rollers

### Akai

#### AKAI PINCH ROLLERS FROM VS SERIES

The original pinch roller used in some VS series Akai VCR's was a one piece type. The roller only for this assembly is VPR67. The one piece assembly has been upgraded and if a complete assembly is ordered then a new TWO piece type (VPR150) will be supplied. The roller only for VPR150 is a VPR69. We recommend using VPR150 for reliable service.



OLD TYPE

#### AKAI ROLLER ASSEMBLY

Original Part No	BL-387501J1
Equiv.	BL-V1075A180D
Suit	VS22,26,35,55,66,75,77,VS422,425,465,725, VSA650,VSF10,11, 220,221,400,410,V SF422,425,430,600
Code	VPR150

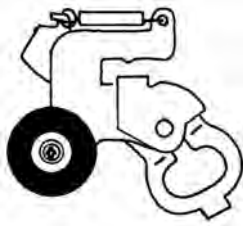

#### AKAI PINCH ROLLER

Original Part No	BL433609N3, N4
Suit	VSG280, VSG2DPL, VSG765, VSG790, VSG875.
Code	VPR156

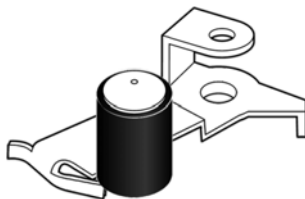

### Daewoo

#### DAEWOO

Original Part No	97SB381800, 79TD3701
Suit	VN22,25, NEC, AWA, etc
Code	VPR185

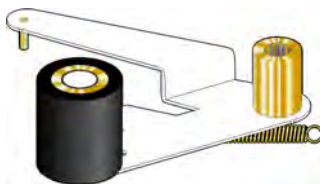

#### DAEWOO

Original Part No	97SA310700
Suit	D284G, etc.,
Code	VPR187



### Funai / Teac

#### FUNAI/TEAC

Original Part No	8059-06-301
Suit	VCR417 & More...
Code	VPR180

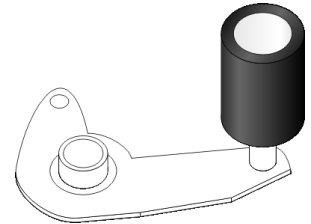

### Goldstar / LG / NEC

#### GOLDSTAR

Original Part No	333-209
Code	VPR170

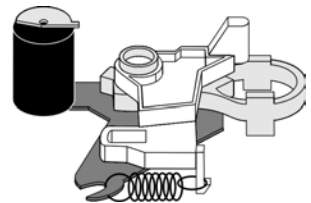

#### GOLDSTAR / NEC PINCH ROLLER

Original Part No	340-070A, 340-073A, 340-195A, 386-401A, 4930-0138A, NEC 79VG1020
Suit	W903H, VN36, P23H, etc.
Code	VPR171

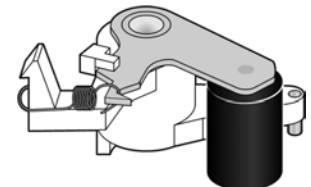

#### GOLDSTAR LG PINCH ROLLER

Original Part No	4261R0011A
Suit	AC250, 450, 950, AF293, 493, 993, Akai VSJ200, 215, 411, VSJ416, 700, 711, VSJ716, etc...
Code	VPR230



### Hitachi

#### HITACHI PINCH ROLLER

Original Part No	6975768, 6384352
Suit	VTM598E, VTM838E
Code	VPR220

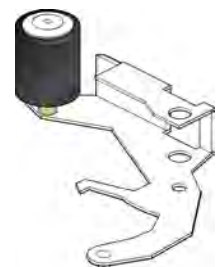



## JVC / Philips

### JVC

Original Part No PQ43558  
 Suit HRD520, 640, 830, HRDS5000, HRDX20EA, Philips VR3241, VR3275  
 Code VPR143



Lifter to suit  
 PQ32415 \$1.59

### JVC

Original Part No PQ42006B  
 Suit HRD170, etc. HRD200,210, HRS5000, HRS5500, HRS9000  
 Code VPR141

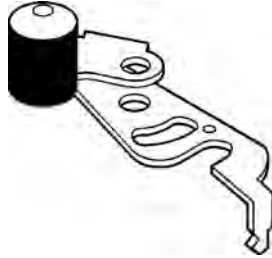

### JVC PINCH ROLLER

Original Part No PQ45921E, PQ45921A6  
 Suit HRJ600  
 Code VPR139



### JVC

Original Part No PQ40134B  
 Suit HRD110,120, HRD121,225, NEC N531,830,833 GR8100, 9300, and others.  
 Code VPR140

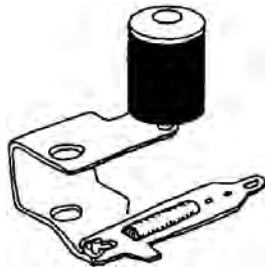

### JVC PINCH ROLLER ARM

Original Part No JVC PQ46327A-2 Philips 482252811051  
 Suit HRJ425, 435, HRJ625, etc. Philips VR656-75, VR555-75  
 Code VPR142

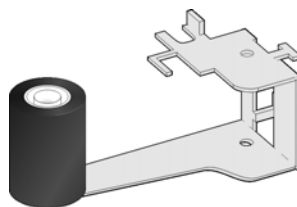

### JVC / PHILIPS PINCH ROLLER

Original Part No LP40105-001A/B 4822-402-11057  
 Suit HRJ255, 455, HRJ655, 755, VR288, 388.  
 Code VPR165

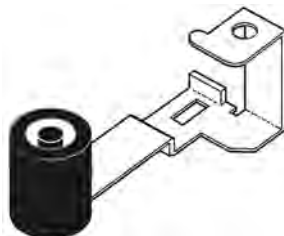

## Mitsubishi

### MITSUBISHI

Orig. 948D20010 or 789C007020  
 Suit HSE11,12,21,

#### ORIGINAL

Code VPR160

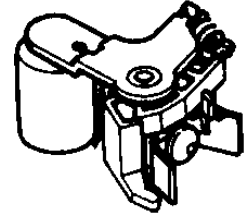

### MITSUBISHI PINCH ROLLER

Original Part No 948D044001  
 Suit HSM50,X3, HSMX5,X7, HSMX10,20.  
 Code VPR175



## NEC

### NEC

Suit VN26,26 NEC 79TD3683 97SA300600  
 Code VPR186

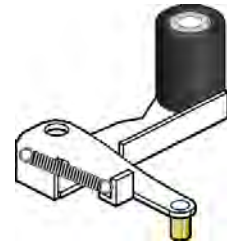

## National

### NATIONAL NV-M

Original Part No VXL1674 VXL1772  
 Suit NV-MC10 NV-MC30, MS50  
 Code VPR118 VPR136

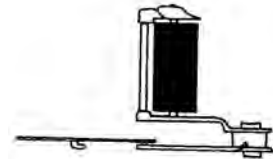

### NATIONAL

VXL1858 or VXL1743  
 NV-G20,21,22,25, NV-G28,40,45,... NV-D38,D48, NV-H65,H75, RTV740, etc...

Code VPR120

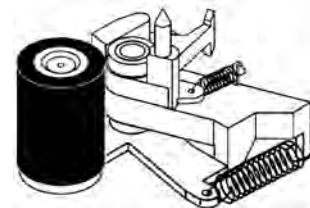

### NATIONAL

Original Part No VXP0330  
 Suit NV2000, 3000, Series  
 Code VPR130





## ☐ Panasonic

### PANASONIC

Suit NVSD Mech.  
Code VXL2246

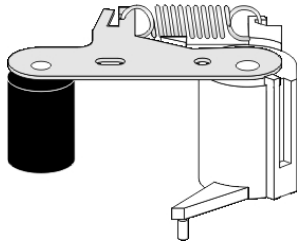

### PANASONIC PINCH ROLLER

Original VXL2676, VXL2785  
Part No

Suit NVSD220, 270, 420,  
NVHD620, 670.

Code VXL2676

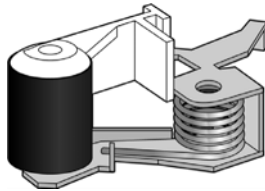

#### Roller Only

Code VPR123

## ☐ Philips / Teac

### PHILIPS TEAC PINCH ROLLER - UPDATE

Original 4822 528 70774, 8619  
Part No 119 175

Suit MV7, 77, 777, RTV785,  
VR9489,

Code VPR274



(Differs to original by roller shaft diameter)

### ROLLER ONLY - 2 TYPES 2.5mm & 3mm

**3.0mm BEARING SHAFT**  
ROLLERS ONLY  
Fits the new VPR274

Code VPR125

**2.5mm BEARING SHAFT**  
Roller only. Suit original.

Code VPR124

VPR274 (Above) will replace assemblies in ALL units!



Roller Only - 2.5mm or 3mm

## ☐ Samsung

### SAMSUNG

Original 61523002101

Part No

Suit VB300, VB370, etc.

Code VPR190

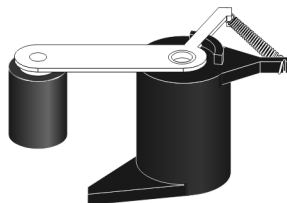

## ☐ Sanyo

### SANYO PINCH ROLLER

Original 613-151-8803

Part No

Suit VHR510,530,  
VHR590,610,  
VHR630,650.

Code VPR205

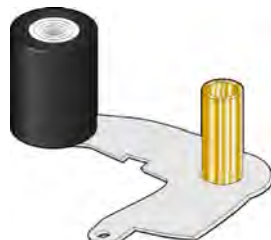

## ☐ Sharp

### SHARP

Original MLEVF0281GEZZ

Part No

Suit VCA10,30,35,60,105,  
111,115,125,505,etc...

Code VPR134

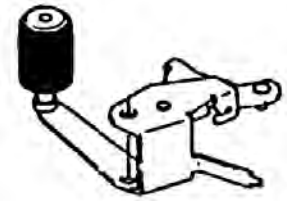

### SHARP

Original MLEVF0416GEZZ

Part No

Suit VCA36X,37X,50X

Code VPR416

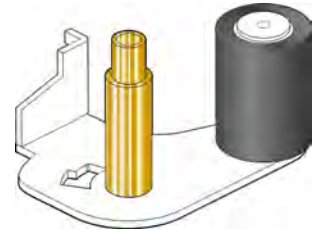

### SHARP PINCH ROLLER

Original MLEVF0500GEZZ

Part No

Suit VCA220, 270, VCA420,  
470.

Code VPR500

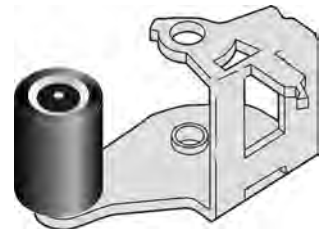

## ☐ Sony

### SONY PINCH ROLLER

A-6759-344-A, X-3669-  
307-1, X-3670-063-1,  
X-3679-264-1, X-3691-  
646-1

Suit SLC9, 34, 40, etc.

Code VPR195

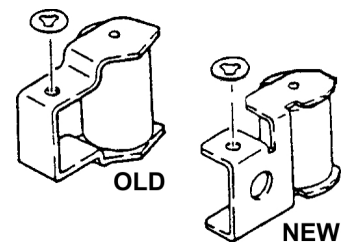

OLD

NEW

### SONY PINCH ROLLER

X3749-173-4, X3749-770-1

Suit SLV215,353

Suit SLV757,777,  
SLVX30,X50,  
SLVX810,etc.

Code VPR200

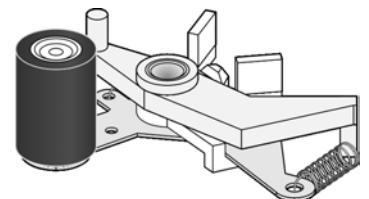



## Video Pinch Roller Listing

### VIDEO PINCH ROLLERS AND ASSEMBLIES

Please note that the substitution listing is to be used as a guide only. There are many more models which are not listed. Please measure the roller required and choose from the dimensions listed.

Suit	Amm x Bmm x Cmm	Code
ORION VC-RLS, VL-BF, UD-LS	15 X 18 X 4	VPR35
GOLDSTAR 434-037D GHV SERIES.	18 X 17 X 4	VPR40
SONY ALL LATE MODEL VHS SLVX30,35,50,etc. Sharp VCA, VCH, etc.. ROLLER ONLY FROM VPR134 Philips VR6448, 6449, 6548, 6591,etc... Goldstar RG20, AWA AV66,etc... * Please Note! Similar outer dimensions to VPR121 *D = 7.7mm	14 X 18 X 3 X *	VPR50
SONY SLVX37, KV14VMIAS	17 X 19 X 4	VPR52
SONY SL-C5, C7, J7, T7, T9, 8000, 8080	16 X 19 X 3	VPR55
AKAI-VS10,9300, 9500, 9800, AKAI VP77, * HMV VP77 JVC-HR2200, 3300, 3330, 3660, RANK VP100 PALSONIC VCR5000, 6000	15 X 21 X 4	VPR56
NATIONAL NV250, 280, 370, 430, 450, 460, 470, 730, 770, 830, 850, 870, 2000, 3000, 7000, 7200, 8400, 8600, 8610, 8620 NV-G7, 9, 10, 11, 16, 30, ORION VH-1, 2, 2B PHILIPS VR6920, GENERAL VGX540A, 625A	18 X 23 X 3	VPR57
SANYO VTC5000, 5005, 5300, 5400, 5500, 6000, 6500, 9100, 9300, 9350, M10, M20, M30, M50 and others.	15 X 19 X 4	VPR58
NROLR0005GEZZ SUITS EARLY MODEL SHARP VC6000,6300,7000 8000,9000, ALL 300 SERIES plus VC2300,3300 ORION VH3 AKAI VS11, 12, TEMPEST TE77R, TE90H, DISTAR DS757, PHILIPS VR401,501,502,701,901 AKAI VS11, PYE VRD100L SAMSUNG VB750, VB970,971, VB8220 PLUS OTHERS.THIS IS A VERY POPULAR TYPE USED IN TOO MANY MODELS TO LIST.	18 X 20 X 4	VPR59
HITACHI-VT7, 11, 14, 17, 33, 35, 88E, 4000, 4200, 5000, 6500, 6800, 7000, 8500, 9300, 9500, 9700, and FISHER FVH-P520, 530 and others.	15.5 X 22 X 4	VPR60
AKAI- VS9700	16.5 X 20 X 4	VPR61
AKAI- VS1, 2, 3, 4, 5, 6, 8, 15 and others.	13 X 18 X 3	VPR64
AKAI- VS112, 155, 165, 240, 515	18 X 20 X 3	VPR66
AKAI- VS33, 35, 53, 55, 66, 422, 425, 426, 427, 725, VSF10, 11, 220, 400, 410, 422, 425, 430, 600 * NOTE. THIS SUITS THE ONE PIECE TYPE ASSEMBLY. * SEE DETAILS ON THE NEXT PAGES FOR "AKAI PINCH ROLLERS	18 X 18 X 3	VPR67
AKAI VS202, 303, 606, 607 VSP8	16 X 20 X 3	VPR68
AKAI VS22, 35, 53, 66, 422, 425, 725 VSA77, VSF10, 11, 400, 410, 422, 425, 430, 600 * NOTE. THIS SUITS THE 2 PIECE TYPE ASSEMBLY.	18 X 18 X 3	VPR69
NEC ALL 900 & MANY 9000 SERIES, DX1600, DX3000, Original P/No. 016-17-8363, PALSONIC VCR9688, TEAC MV3010, 30, 50, MV4010, 6010.	16 X 19 X 4	VPR70
NEC DS6000A, N9073, N9570	15 X 17 X 4	VPR71
TEAC/FUNAI MV305, 307, 330, 400, 417, 430, 435, 440, 445, 450, MV1440TV, MV220TV GENERAL VGX815A PLUS EQUIVALENTS eg. CASIO, TANDY etc.	15 X 19 X 4	VPR72
MITSUBISHI AV SERIES AV12, 14, 47, 51, 58, 59, 400, 410, HS SERIES HS30, 304, 306, 307, 310, 318, 319, 337, HS338, 347, 349, 400, 410, 411, 412, SOME HSE SERIES HS-E10, 20, 70, 347 THORN TR102	15 X 18 X 4	VPR75

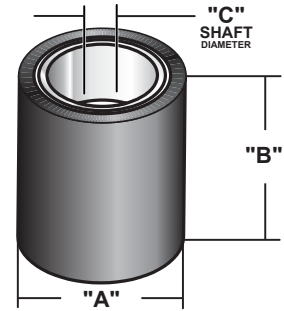

**TOO MANY MODELS TO LIST HERE!**

**IF YOUR VCR IS NOT LISTED, PLEASE ENQUIRE!**

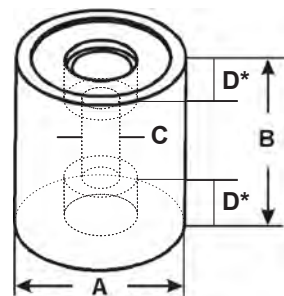

**MORE SUBSTITUTES AVAILABLE SEE:**

<http://www.wes.com.au>





## VIDEO PINCH ROLLERS AND ASSEMBLIES

Suit	Amm x Bmm x Cmm	Code
MITSUBISHI HSE11, 12, 21, 27, 31, 41... Also HSM and HSMX Series. SAMSUNG SV10, 11, 12, 30, 80, 81, 140	14 X 17 X 3	VPR76
HITACHI VT100, 128, 135, 138, 168, FISHER FVH-P905, 908, 910, 911, etc.	15.5 X 19 X 4	VPR78
FISHER FVH-P620, 710, 720, 725	15.5 X 21 X 4	VPR80
NATIONAL- NV100, 600, 300, 333, 777, 788, and BLAUPUNKT equivalents.	16 X 23 X 3	VPR87
JVC HR2650, 7200, 7600, 7610, 7655, 7650, 7700 GE-V9600 * HMV4000, 7000 RANK RV330, 340, 350 * T/FUNKEN VR530	17 X 21 X 4	VPR90
HRD170, 180, 200, 210, 230, 300, 320, 330, 337, HRD370, 377, 400, 430, 470, 530, 700, 750, 950, HRS5000, 5500, 9000, etc..	17 X 17 X 4	VPR104
JVC HR-D110, 111, 120, 121, 125, 140, 150, 160, 225, 250, 455, 565, 566, 755, NEC ALL 800 SERIES N830, 833, 895 ETC TOSHIBA V55, 57, 71, 73, 75, 81, 83, 84, 85, 86 GENERAL GE8100, 9300 THIS IS A VERY POPULAR TYPE USED IN TOO MANY MODELS TO LIST	17 X 18 X 4	VPR105
JVC HR-D230, D520, D521, D530, D540, D580, D600, D610, D620, HR-D830, HR-DX20EA, HR-S5800, & PHILIPS VR3241/75	16 X 17 X 4	VPR106
Philips VR2020, 2022, 2023, 2021, 2024	12.5 X 20.5 X 3	VPR107
SHARP all VC400 & 500 series eg. VC481, 581 etc. AKAI VS200 & VSP3, DEITRON DVR6158, ESC VCR8025, Philips VR6440, 6441, 6540, 6541, 6640, 6641, 6740 etc. Tempest TE99, TE900, TE970R, Trackton VCR32, VCR52, Orion VCP Samsung VB617C, 627, 629, 900, 910 etc. Marantz MV740A Goldstar GHV1232, 1240, 1246, 1291, 1295, 1296, etc Videopro VCR8025 THIS IS A VERY POPULAR TYPE USED IN TOO MANY MODELS TO LIST.	18 X 17 X 4	VPR108
NEC VN22, 23, 25, 26 97SB361200 DAEWOO DVR4773 70322134 2H20D 4H40D TOSHIBA V31, 33, 51, 53, 8600, 8650, 9600, VP88	15 X 17.5 X 3	VPR110
SHARP P/No. ROLR0013GEZZ Suit VC-6V3, VC600, 682, 685, 693 SHARP 700 SERIES VCA101, 103, VCH851, etc. PHILIPS 6442, 6443, 6520, 6542, 6543, 6549 etc. THIS IS A VERY POPULAR TYPE USED IN TOO MANY MODELS TO LIST	18 X 18 X 4	VPR113
SANYO 6130372161 VHR1300, 1500, 2500, 2700	16 X 23 X 3	VPR115
SANYO VHR3100, 3300, 3700, VHR-D500, D700	16 X 18 X 3	VPR116
SANYO VHR120, 4100, 5100, 5200, 5300, 5700, 7100, 7200, 7500 VHR-D4600, D4800, S700, VN-20, 31, 32, 70, 71, NEC VH81, 90, 91.	15.5 X 18 X 3	VPR117
ROLLER ONLY FROM VPR120, VXL1743 & VXL2676 Panasonic NVG series NVG20,21,22,25,40 AND MANY OTHERS. Panasonic NVJ, NVL, NVF, NVD series. SHARP LATE VCA SERIES BLAUPUNKT RTV560,740, etc... TEAC/FUNAI MV3410,4810 * Please Note! Similar outer dimensions to VPR50 and VPR123 *D = 8.3mm	14 X 18.5 X 3 X *	VPR121
ROLLER FROM VXL2785 (NOT VXL2676 - Check "C") Panasonic NVHD620A, 670A, NVSD220A, 270A, 420A. GOLDSTAR AF293, 493, 993, AC250, 450, 950. AKAI VSJ200, 215, 411, 416, 700, 711, 716. SANYO VHR-VK210, NEC VN204 * Please Note! Similar outer dimensions to VPR50 and VPR121	14 X 18.5 X 2.5	VPR123
NEW! - PHILIPS BLAUPUNKT TEAC, etc,	12.5 X 17 X 2.5	VPR124

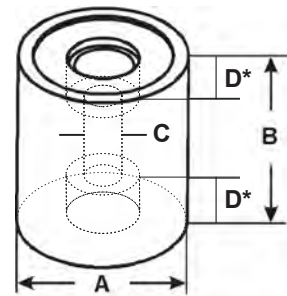

**TOO MANY MODELS TO LIST HERE!**

**IF YOUR VCR IS NOT LISTED,**

**PLEASE ENQUIRE!**

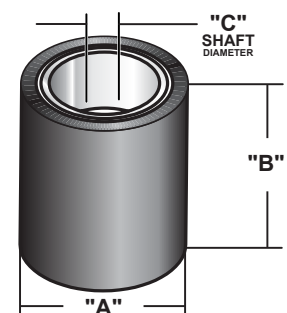

**MORE SUBSTITUTES AVAILABLE SEE:**

<http://www.wes.com.au/>



## Overhaul Kits

## JVC OEM

### OVERHAUL KITS

The following kits are manufactured by the original corporations in Japan and contain all the parts which they recommend to be replaced when the VCR is being serviced.

Please note that many brands use the following kits. We have listed as many models as we are aware of and/or space would allow.

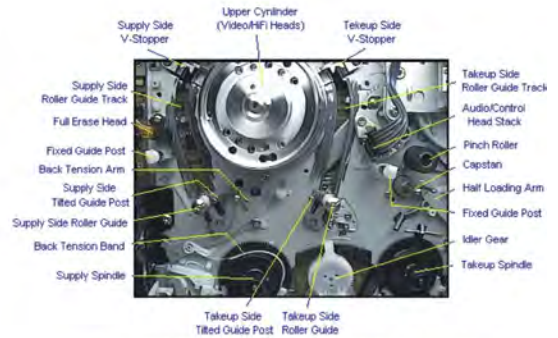

Typical VHS VCR Tape Transport Components

### ORIGINAL JVC OVERHAUL KIT

Suit	HR-D120, HR-D225, NEC N830, 831, N833, GE GEV-7300, GEV-8100, GEV-9300, RANK RV360, RV370, 380.
Code	PTU96075

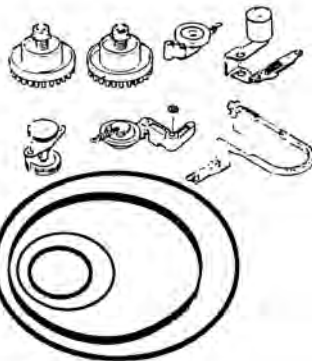

PQM3003	BELT(D=46mm)
PQM3003-7	BELT(D=116mm)
PQM3003-8	BELT(D=28mm)
PQM3004	BELT(D=27mm)
PQM30017-5	SLIT WASHER X2
PQM30017-8	SLIT WASHER X2
PQ40134B	PINCH ROLLER
PU48907D	REEL DISK ASS.
PU48907E	REEL DISK
PU51390A	TENSION BAND
PU51402A	T'UP IDLER ARM
PU55373	T'UP CLUTCH
PU55374-3-8	IDLER ARM

### ORIGINAL JVC OVERHAUL KIT

Suit	HR-D455, HR-D725, TOSHIBA V63
Code	PTU96078-2

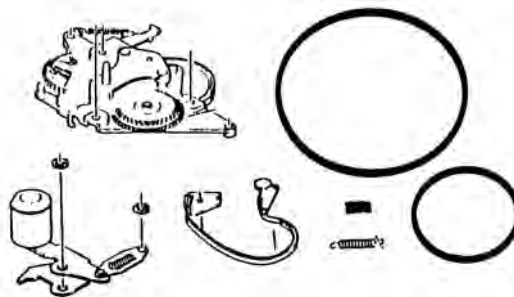

PQM30003-10	BELT(D=55mm)
PQM30003-14	BELT(D=30mm)
PQM30017-12	SLIT WASHER X2
PQM30017-8	SLIT WASHER
PQ40252B-4	P'ROLLER & ARM
PQ40262E	TENSION BAND
PU55822A-10	CASSETTE MECH.
PQM30001-138	TENSION SPRING
PQM30019-14	PAD

### ORIGINAL JVC OVERHAUL KIT

Suit	HR-D160, 171, HR-D180, HR-D211, 230, HR-D300, 320, HR-D321, 337, HR-D470, 530, HR-D750, HR-S5000 HR-S5500
Code	PTU96079

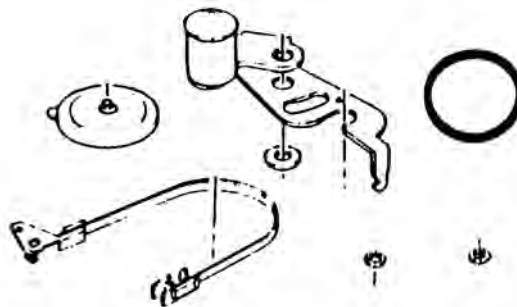

PQM30003-20	BELT(D=19mm)
PQM30017-28	SLIT WASHER
PQM30017-5	SLIT WASHER X2
PQ41948A	TENSION BAND
PQ42006B	P'ROLLER & ARM
PU58645-1-4	IDLER ARM

### ORIGINAL JVC OVERHAUL KIT

Suit	HR-D540, HR-D580
Code	PTU96082

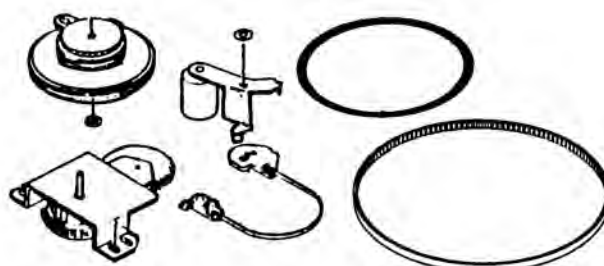

PQM30003-23	BELT(D=64mm)
PQM30017-12	SLIT WASHER
PQM30017-8	SLIT WASHER
PQ43501B-11	TENSION BAND
PQ43921B-2	P'ROLLER & ARM
PU61004-1-3	IDLER GEAR UNIT
PU61005-1-4	CLUTCH UNIT
PU61006	TIMING BELT



## ORIGINAL JVC OVERHAUL KIT

Suit HR-D520, HR-D521,  
HR-D600, HR-D610,  
HR-D620, HR-D830  
Code PTU96083

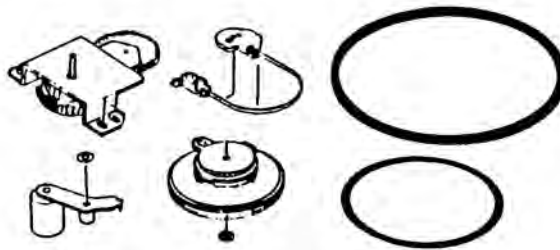

PQM30003-23 BELT(D=64mm)  
PQM30003-24 BELT(D=93mm)  
PQM30017-12 SLIT WASHER  
PQM30017-8 SLIT WASHER  
PQ43501B-11 TENSION BAND  
PQ43558A P'ROLLER & ARM  
PU60618-1-3 IDLER GEAR UNIT  
PU60953-1-2 CLUTCH UNIT

## ORIGINAL JVC OVERHAUL KIT

Suit HR-7200 & Equiv. GE  
GEV6900, HMV HV4000,  
RANK RV340  
Code PTU96095

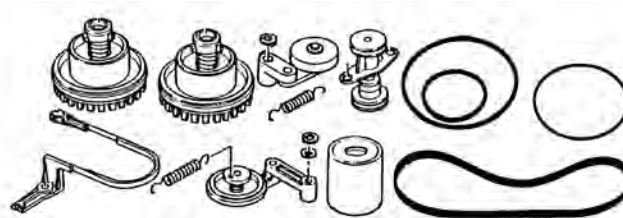

PQM30003 BELT(D=45mm)  
PQM30003-2 BELT(D=64mm)  
PU48941-2 BELT(D=29mm)  
PU49164 BELT(D=88mm)  
PQM30017-5 SLIT WASHER X2  
PQM30017-6 SLIT WASHER X2  
PU48907C REEL DISK  
PU48907D REEL DISK  
PU48967B IDLER ASSEMBLY  
PU51367A PINCH ROLLER  
PU51390A TENSION BAND  
PU51402A TAKE UP IDLER  
PU53462A TAKE UP CLUTCH

## ORIGINAL JVC OVERHAUL KIT

Suit HR-7600, HR-7650,  
HR-7655, GE GEV8900,  
HMV HV8000, RANK  
RV350  
Code PTU96097-2

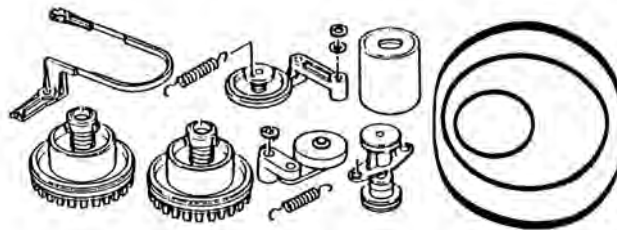

PQM30003 BELT(D=46mm)  
PU48941-2 BELT(D=29mm)  
PU49164 BELT(D=88mm)  
PQM30017-5 SLIT WASHER X2  
PQM30017-6 SLIT WASHER X2  
PU48907D REEL DISK  
PU48907E REEL DISK  
PU48967B IDLER ASSEMBLY  
PU51367A PINCH ROLLER  
PU51390A TENSION BAND  
PU51402A TAKE UP IDLER  
PU53462A TAKE UP CLUTCH

## □ National Panasonic OEM

### PANASONIC "G" MECHANISM PARTS KIT

Contains VXL1490, VXL1743,  
VXP0878, VDG0597  
VML1849, VMX1079, washers  
and C rings. As the G mech  
is very popular this kit will suit  
many models eg.  
NV-G20, 21, 22, 33, 40, NV-  
D38, 48, FS1, H65, 75 etc, +  
RTV740,560,etc.

Code  
VUA4104

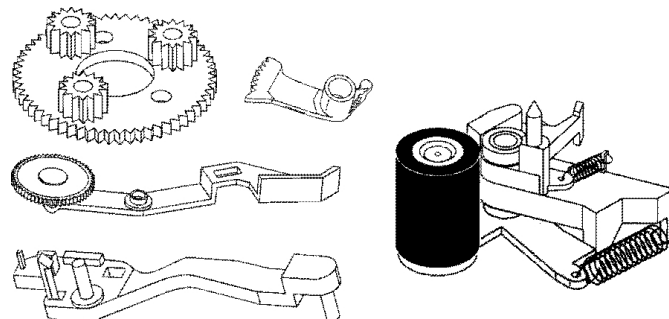

### PANASONIC "G" MECH VIDEO MAINTENANCE PARTS KIT

Suit NVD38, 48, NVF55,  
65, 66, 70, 75, 77,  
NVG33, 220, 300,  
NVJ1, 10,11,30,35,45,  
NVL10,15,20,P10,etc.  
Code VUA4116KIT

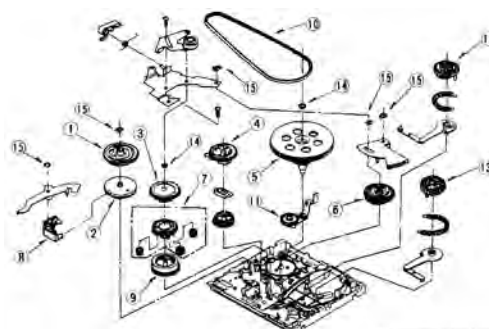

VDG0574 Main Cam Gear  
VDG0343 Sub Cam Gear  
VDG0348 Centre Gear  
VDG0547 Clutch Gear  
VXP0917 Pulley Unit  
VDG0448 Loading Gear  
VXP0878 Gear Unit  
VML1861 Detent Arm  
VDG0342 Ring Gear  
VDV0169 Timing Belt  
VXL1861 Play Arm  
VDG0564 Load Gear T  
VDG0419 Load Gear





# Video Repair Parts

## ❑ JVC Replacement

### ECONOMY OVERHAUL KIT - JVC

Original & Non-original parts. Suit JVC HR3330, HR3600,3360, HR3660 and eq's. Contains; PU47752 Take up clutch, PU46381 Unloading idler Belts, tyres, Pinch roller

Code  
VUD1101

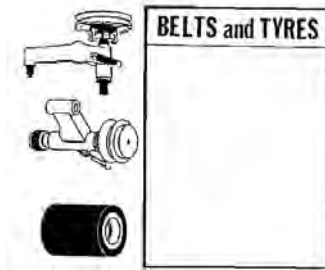

### ECONOMY OVERHAUL KIT - JVC

Original & Non-original parts. JVC HR7200 7650, 2650 etc Contains; Idler assemblies PU51402A PU48967B, Take up clutch PU53462A belt kit Tyres pinch roller

Code  
VUD1102

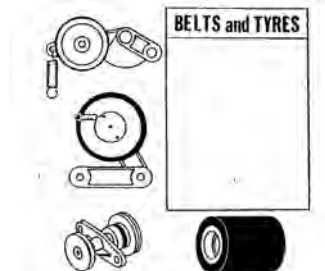

### ECONOMY OVERHAUL KIT - JVC

Original & Non-original parts. JVC HRD-110, 120, etc. NEC N830,831,833 Contains; PU55373 Take up clutch, PU55374-3-8 PU51402A Idler arms Belts and Pinch roller.

Code  
VUD1103

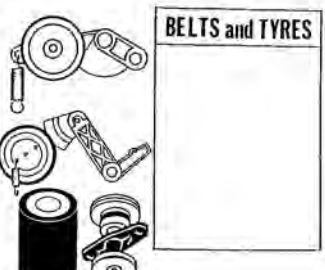

## ❑ National Panasonic Replacement

### ECONOMY OVERHAUL KIT - NATIONAL

Original & Non-original parts. NATIONAL NV2000 Contains; VXZ0076 Tension band, VDP0908 Roller, VXP0329 Idler, VXP0331 Idler, VXPO351 Clutch, VXP0332 Brake belts, pinch roller Circlips & Washers

Code  
VUD4087

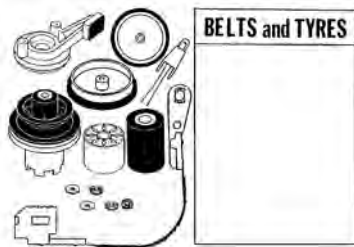

### ECONOMY OVERHAUL KIT - NATIONAL

Original & Non-original parts. NATIONAL NV7000,7200... Contains; VXP0343 Idler, VXP0344 Idler, VDP0908 Roller, VXZ0078 Tension band belts,roller Circlips, and washers.

Code  
VUD4088

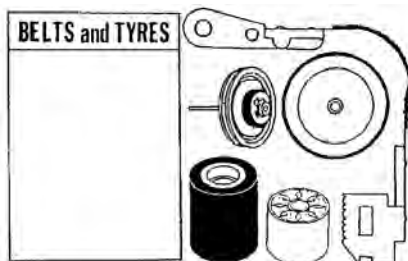

### ECONOMY OVERHAUL KIT - NATIONAL

Original & Non-original parts. NATIONAL NV730, 770... Contains; VXP0581 Idler, VDG0177 Gear, VDP0908 Roller, VXZ0165 Tension band Belts,roller Circlips,etc.

Code  
VUD4091

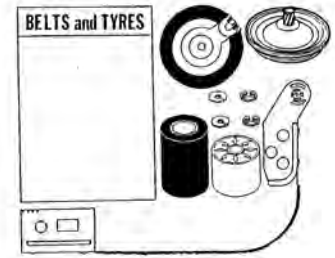

### ECONOMY OVERHAUL KIT - NATIONAL

Original & Non-original parts. NATIONAL NV250, NV280, 470, 870... Contains; VXP0521 Idler, VDP0908 Roller, VXZ0165 Belts Pinch roller Circlips and Washers.

Code  
VUD4093

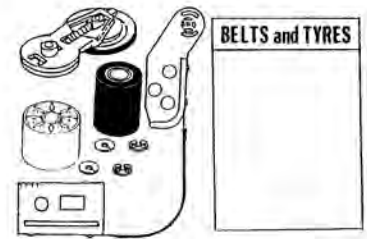

### ECONOMY OVERHAUL KIT - NATIONAL

NATIONAL NV300, NV333, 340... Contains; VXP0434 Idler, VXP0401 Idler, VDP0908 Roller, VXZ0129 Tension band Belts & p'roller Circlips, washers.

Code  
VUD4089

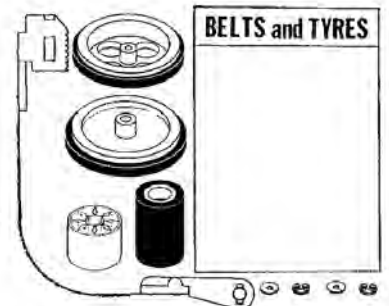

### ECONOMY OVERHAUL KIT - NATIONAL

Original & Non-original parts. NATIONAL NV370, NV850... Contains; VXP0521 Idler, VDP0908 Roller, VXZ0165 Belt All belts, Pinch roller, Circlips and Washers.

Code  
VUD4092

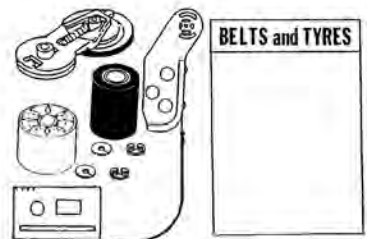

### ECONOMY OVERHAUL KIT - NATIONAL

Original & Non-original parts. NATIONAL NV-G7→18 NVG30/H70/65... Contains; VXP0521 Idler, VXL1371 Roller ass'y, VXZ0165 Tension band Belts Washers and Circlips

Code  
VUD4103

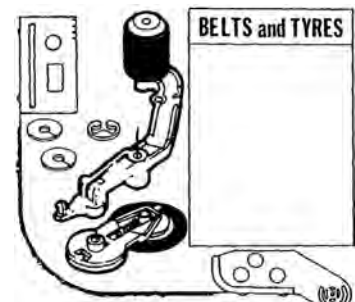





## Idlers & Gears

### Akai

#### AKAI IDLER ASSEMBLY

Original MI327773  
 Part No  
 Suit VS2,3,4, 5,6,8,15.  
 Code VIA32

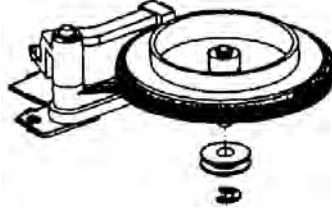

#### AKAI IDLER

Original MI361964  
 Part No  
 Suit VS606  
 Code VIA38



#### AKAI EJECT CAM GEAR

Original MZ-360428  
 Part No  
 Suit VS105, 112, VS115,116  
 Mech. "A"  
 Code MZ360428

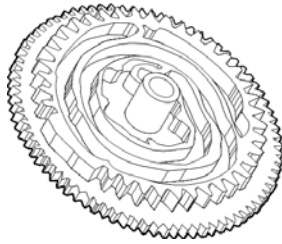

#### AKAI CAM GEAR

Suit VS112,165. Mech. "A"  
 Code MZ360429

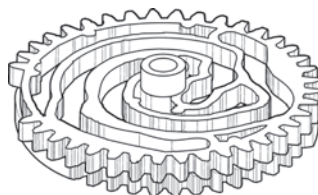

#### AKAI CAM GEAR No.1

From cassette housing VS303  
 Code MZ353166



#### AKAI IDLER

Original MI361964  
 Part No  
 Equiv. BL-B35110  
 Suit VS202,303  
 Code VIA25



#### AKAI IDLER ASSEMBLY

Original BV-327815  
 Part No  
 Suit VS2,3,4, VS5,6,8,15.  
 Code VIA35



#### AKAI IDLER ASSEMBLY

Original MZ366960  
 Part No  
 Suit VS105,112, 115,116,  
 155,165, 240,515,X9...  
 Code VIA50

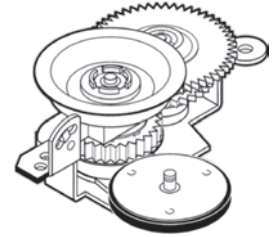

#### AKAI EJECT CAM

Original MZ364677 Also  
 Part No MZ367952  
 Suit VS112 Mech. "B"  
 Code GR3679



#### AKAI CAM GEAR

Suit VS112,165. Mech. "B"  
 Code MZ364676

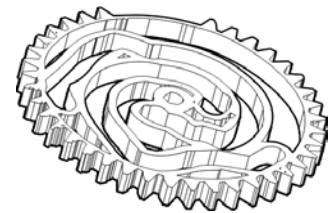

#### AKAI CAM GEAR No.4

From cassette housing VS303  
 Code MZ353169

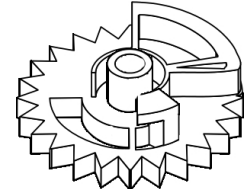

#### AKAI CLUTCH GEAR

Original ML373043  
 Part No  
 Suit VS25,35, VS53,55  
 Code ML3730

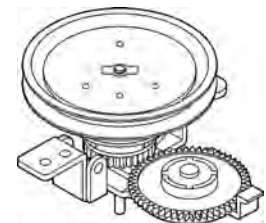

#### AKAI GEAR ASSEMBLY

Original MI387294J  
 Part No  
 Code GR3872

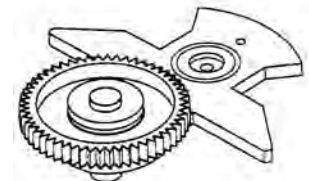

#### AKAI GEAR

Suit VS22,26,35 etc.  
 Code MZ368795T1

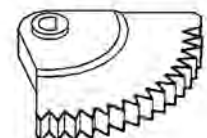



# Video Repair Parts

## AKAI GEAR

Original MZ-368794T  
 Part No  
 Suit VS35,53,55  
 Code MZ368794



## AKAI LOADING ARM

Original ML-368793T  
 Part No  
 Suit VS35,53,55  
 Code ML368793

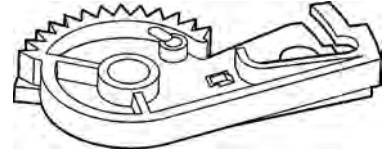

## AKAI GEAR CAM JOINT

Original MZ368797T  
 Part No  
 Suit VS22  
 Code GR3687



## AKAI ARM SHUTTER

Cassette lid opening  
 Code  
 ML387349

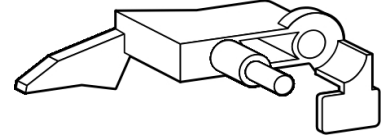

## AKAI LOADING ARM

Original MZ-V1075A090A  
 Part No  
 Suit VS35, etc.  
 Code GR5090

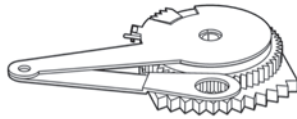

## AKAI LOADING ARM

Original MZ-V1075A100A  
 Part No  
 Suit VS35, etc.  
 Code GR5100

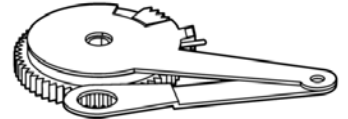

## AKAI LOADING GEAR

Original VT780025  
 Part No  
 Suit VS1,2,3,4 VS5,6,8  
 Code GR7800

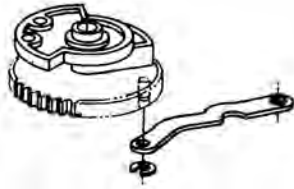

## AKAI GEAR

Suit VSF12 etc.  
 Code MZ387333J

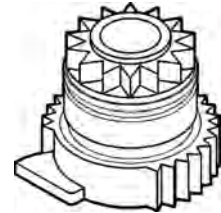

## AKAI LEVER ROLLER LINK

Original BL-B353126  
 Part No  
 Suit VS202, VS303  
 Code BL3531

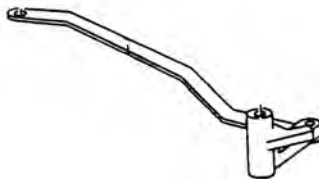

## AKAI LOADING GEAR

Use with GR7800

Original VT780026  
 Part No  
 Code GR7802

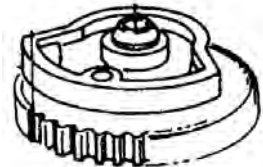

## AKAI EJECT LEVER

Original ML749693  
 Part No  
 Suit VS6,8,15, etc.  
 Code ML749

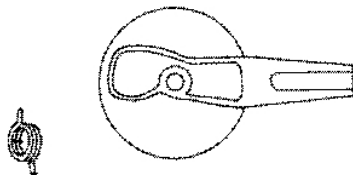

## AKAI ARM OPENER

Original ML-353161  
 Part No  
 Suit VS202, VS303  
 Code ML3531



## SPRING TO SUIT

Code  
 ZG749



## AKAI LOADING ARM

Original ML-368792T  
 Part No  
 Suit VS35,53,55  
 Code ML368792

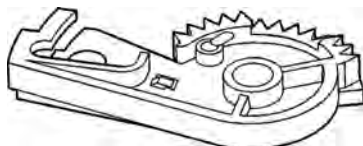

## AKAI ARM

Suit VS422, VS425  
 Code ML387321

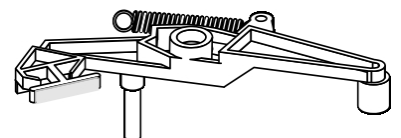



## AKAI TAKE-UP TAPE GUIDE

Original Part No MS-372186J1  
 Suit A/C head block. VS35, 53, 55  
 Code MS372186

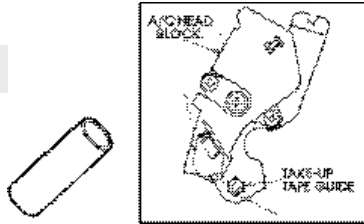

## AKAI CLUTCH DISC

Original Part No MZ387298J  
 Suit VS965 VSF30, 300, VSF261, 441, VSF510, 600, VSG10, 43, 50.  
 Code MZ387298

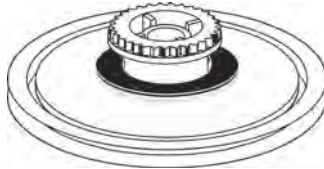

## AKAI \*

**VS422,425,465,765,965, VSA650,F10,F11,F12,F30,F600**  
 Avoid repairs bouncing because of cassette jamming. Fit/check/replace the following when servicing any of the above models.  
**Mod:** Insert MZ732818 to support the Front loading slider and stop it from jumping the Front loading gear

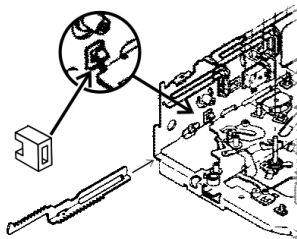

## \*AKAI SPACER OUTSERT

Modification part. Mount under "Hook" part.

Code MZ732818

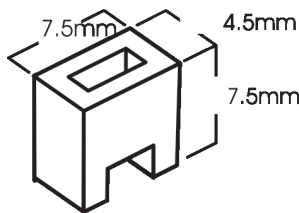

## \*AKAI AIR DAMPENER

Check spring retainer (Hook) Replace if worn.

Original Part No ML391745J3  
 Code ML3917



## \*AKAI SHAFT GEAR EJECT

Machined brass Replace if shaft broken.

Code MS732791

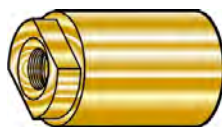

## AKAI SLIDE LEVER

Original Part No ML420168N2  
 Suit VSF440, VSG204, 216, VSG246, 305, VSG315, 317, VSG415, 445.  
 Code LEV0168

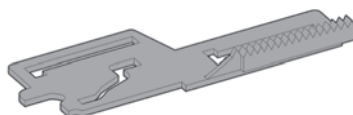

## AKAI GEAR

Original Part No MZ420123N  
 Suit VSG204, 211, VSG405, 511, VSG740, 855, VSG2200, etc.  
 Code GR4201

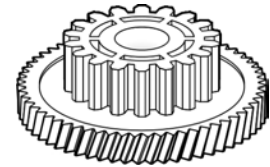

## AKAI LOADING ARM

Original Part No MZ424917N00  
 Suit VSG204,...212, VSG405, 511, VSG2100, etc.  
 Code GR4917

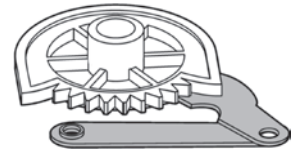

## AKAI LOADING ARM

Original Part No MZV1102A090A  
 Suit VSG10,11,30, 33,34,35,40, 43,44,45,50, 54, etc.  
 Code GR2090

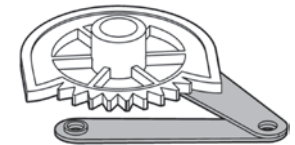

## AKAI LOADING ARM

Original Part No MZV1102A100A  
 Suit VSG10,11,30, 33,34,35,40, 43,44,45,50, 54, etc.  
 Code GR2100

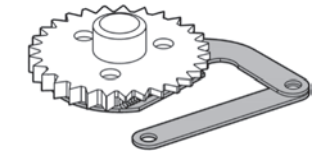

## AKAI CASSETTE LOADING ARM

Original Part No BL424913N06  
 Suit VSG204,...212, VSG405, 511, VSG2100, etc.  
 Code ARM4913

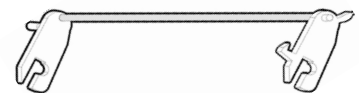

## AKAI GEAR

Original Part No MI420023N4  
 Suit VSG204, 311, VSG405, 511, VSG740, 855, VSG2200, etc.  
 Code GIA4203

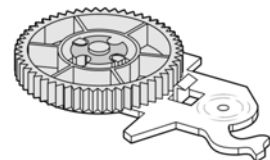

## AKAI CAM GEAR

Original Part No MZ420345J  
 Suit VSG204,...212, VSG405, 511, VSG2100, etc.  
 Code GR4245

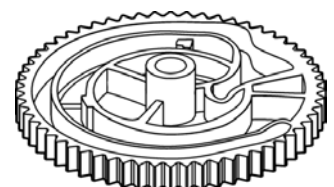





## AKAI PINCH GEAR

Original Part No MZ420067N  
 Suit VSG204,...212, VSG405, 740, VSG2100, etc.  
 Code GR4267

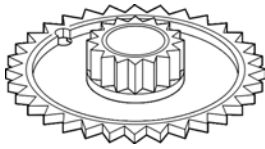

## AKAI CAM GEAR

Original Part No MZ420064N  
 Suit VSG204,...212, VSG405, 511, VSG2100, etc.  
 Code GR4264



## AKAI MAIN CAM GEAR

Original Part No MZ420122N1  
 Suit VSG204,...212, VSG405, 511, VSG2100, etc.  
 Code MCG4222

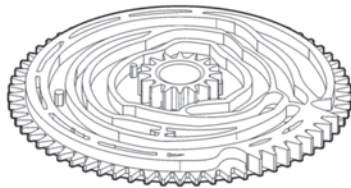

## AKAI CAM GEAR

Original Part No MZ428103N  
 Suit VSG204,...212, VSG405, 511, VSG2100, etc.  
 Code GR4203



## AKAI CAM GEAR

Original Part No MZ428104N, MZ420328N  
 Suit VSG204,...212, VSG405, 511, VSG2100, etc.  
 Code GR4204



## AKAI FRONT LOADING GEAR

Original Part No MZ420124N3  
 Suit VSG204,...212, VSG405, 511, VSG2100, etc.  
 Code GR4224

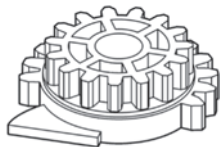

## AKAI REDUCTION GEAR

Original Part No MZ420348J  
 Suit VSG204,...212, VSG405, 511, VSG2100, etc.  
 Code GR4248

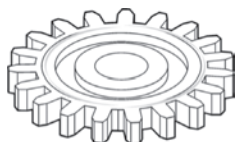

## AKAI LEVER M BRAKE

Suit VSDG411 VSG204,211, VSG311,405, VSG858,etc.  
 Code LEV4299

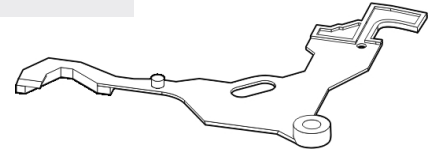

## AKAI ARM LOADING BLOCK END

Original Part No Arm BL433561N7, End BL438155C  
 Suit VSG260, 262, 265, VSG460, 465, VSG765, 875, VSP170, etc.  
 Code BL438155C

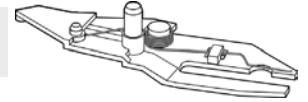

## AKAI SLIDE LOADING PLATE

Original Part No ML433567N1  
 Suit VSG260, 262, 265, VSG460, 465, VSG765, 875, VSP170, etc.  
 Code ML433567

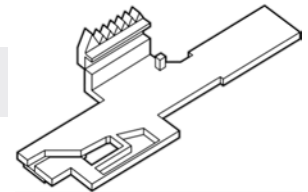

## AKAI DISK REEL

Suit VSG2, 260, 261, 262, VSG263, 265, 267, 270, VSG271, 275, 276, 277, VSG2DPL, PLEAD, 460, VSG465, 467, 470, 475, VSG477, 768, 875, VSP170.  
 Code MT433537N



## □ Akai - See Goldstar LG

## AKAI - SEE GOLDSTAR - LG

Suit VSJ200, 215, VSJ411, 416, VSJ700, 711, VSJ716, etc.  
 See Goldstar AF293, 493, AC250, 450.



## □ Daewoo / NEC / AWA / Tempest

## DAEWOO / NEC / AWA IDLER PLATE

Original Part No 97SB382300  
 Suit VN22, 25, & more...  
 Code VIA3955

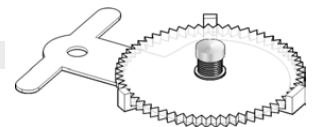

## DAEWOO / NEC / AWA CAM GEAR

Original Part No 97S2714900, 79SB3928  
 Suit VN22, VN25, NEC, AWA, & More.  
 Code MCG3928

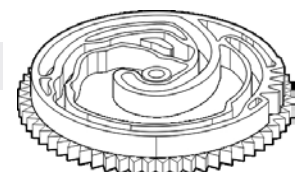





## DAEWOO / NEC / AWA GEAR TAKE-UP

**Original Part No** 97SB382410,  
79TD3956  
**Suit** VN22, VN25, NEC,  
AWA, & More.  
**Code** GIA3956

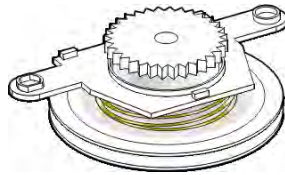

## DAEWOO / NEC / AWA GEAR RELAY

**Original Part No** 79TD3665,  
97S0900700  
**Suit** VN23, 24, 26, 27, 67,  
2H20D, 4H40D,  
DVR4773  
**Code** GR9366

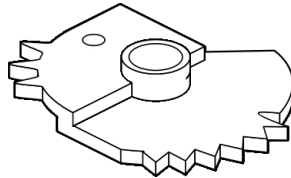

## DAEWOO / TEMPEST CAM GEAR

97S2705600  
Deitron DVR6158D,  
Tempest TE99R, 970R,  
ESC VCR32, VCR8025.  
**Code** GR5600

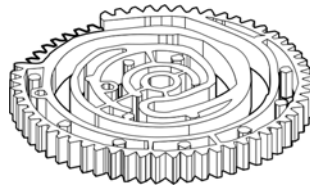

## DAEWOO / TEMPEST IDLER CLUTCH

**Original Part No** 97SA387600  
**Suit** Tempest TE970  
VIDEO PRO  
VCR8025 Trackton  
VCR32 etc.  
**Code** VIA110



## DAEWOO / TEMPEST IDLER CLUTCH

**Original Part No** 97SA507200  
**Suit** Tempest TE970  
VIDEO PRO  
VCR8025 Trackton  
VCR32 etc.  
**Code** VIA100

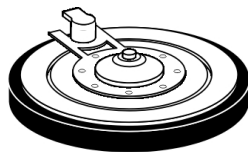

## DAEWOO IDLER ASSEMBLY

Deitron DVR6158D,  
Tempest TE99R  
**Code** VIA102



## DAEWOO SPRING

**Original Part No** 97S3019200  
**Suit** DVR4773 VN20, etc.  
**Code** DAE9200

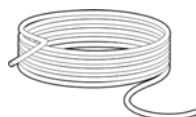

## DAEWOO RATCHET

**Original Part No** 97S2904900  
**Suit** DVR4773, VN20, etc.  
**Code** DAE4900

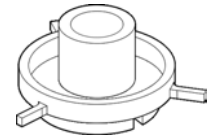

## DAEWOO IDLER GEAR SET

**Original Part No** 79TD4348,  
97SB335500  
**Suit** VN20, DVR4773, etc...  
**Code** GIA4348

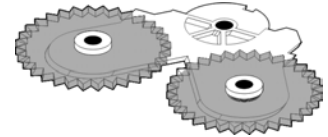

## DAEWOO / TEMPEST RF CONVERTER

Six pins  
**Original Part No** MCB9VA0103  
**Suit** DVR6158, 6358,  
VCR32, 52, 8025,  
TE99R, etc.  
**Size** 44x53x18mm  
**Code** RFVR0103

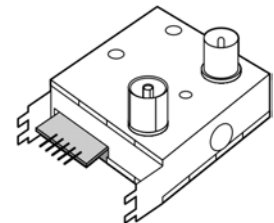

## DAEWOO IDLER

**Original Part No** 79TD3689,  
97SA301200  
**Suit** VN23, 26, 64, NEC,  
AWA, & others.  
**Code** VIA3689

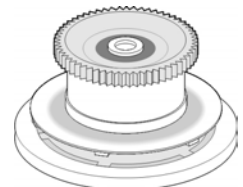

## DAEWOO IDLER PLATE

**Original Part No** 97SA301400,  
79TD3690  
**Suit** VN23, VN26, NEC,  
AWA, and others.  
**Code** GIA3690

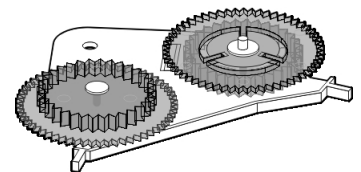

## DAEWOO MASTER CAM GEAR

**Original Part No** 79TD3663  
**Suit** NEC VN23, VN26,  
AWA 2H20D, 4H40D  
**Code** MCG3663

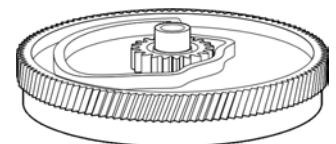

## DAEWOO RELAY GEAR

**Original Part No** 79TD3664  
**Suit** NEC VN23, VN26, AWA  
2H20D, 4H40D  
**Code** GR3664

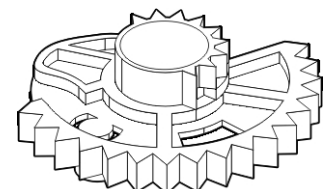



# Video Repair Parts

## DAEWOO / NEC / AWA SLIDE PLATE

Original Part No 97S0900200  
 Suit 2H20D, 4H40D, VN23, 24, VN26, 27, VN64.  
 Code PSM9002

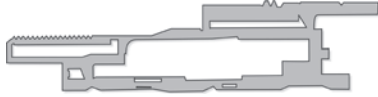

## FUNAI ARM RG ACTUATE

Original Part No 8059-17-01  
 Code FU1701

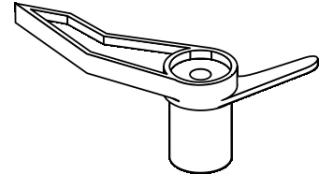

## DAEWOO CLEANER ROLLER

Original Part No 79V15058  
 Suit VN30, VN35  
 Code RL5058



## FUNAI CLUTCH ASSEMBLY

Original Part No 8059-09-302  
 Code FU9302

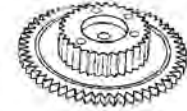

## DAEWOO CAM GEAR

Original Part No 97SA2701400  
 Suit D284G, D884G, DVK10W, 224D, DVK424D, 824D4, MV3080, 6080.  
 Code CAM1400

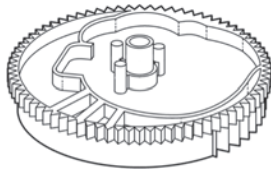

## FUNAI GEAR ASSEMBLY, P

Original Part No 8059-09-305  
 Code FU9305



## DAEWOO LEVER

Original Part No 97S0901400  
 Suit D284G, D884G, DVK10W, 224D, DVK424D, 824D4, MV3080, 6080.  
 Code LEV1400



## FUNAI WORM WHEEL ASSEMBLY

Original Part No 8000-22-313  
 Code FU2313



## DAEWOO CLEANER

Original Part No 97S2701800  
 Suit D284G, D884G, DVK10W, 224D, DVK424D, 824D4, MV3080, 6080.  
 Code LEV1500



## FUNAI EJECT ACTUATE ARM

Original Part No 8059-11-14  
 Code FU1114

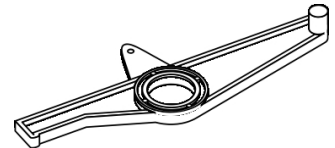

## Funai / Teac / Palsonic

### FUNAI HOOK TRIGGER

Original Part No 8059-10-14  
 Code FU1014



### FUNAI LEVER TRIGGER

Original Part No 8059-10-13  
 Code FU1013



### FUNAI PLATE BRAKE

Original Part No 8059-10-11  
 Code FU1011



### FUNAI ACTUATE BASE

Original Part No 8059-10-09  
 Code FU1009



### FUNAI GUIDE POST

Original Part No 8059-03-04  
 Code FU304



### FUNAI GUIDE POST

Original Part No 8059-03-05  
 Code FU305





## FUNAI GEAR

Original 8059-09-06  
Part No  
Code FU906

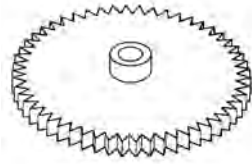

## FUNAI LOADING GEAR RIGHT

Original 8059-03-07  
Part No  
Code FU307

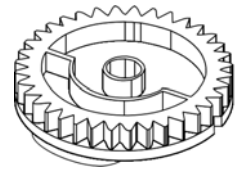

## FUNAI GEAR

Original 8059-09-306  
Part No  
Code FU9306

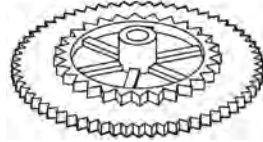

## FUNAI LOADING GEAR

Original 8059-11-04  
Part No  
Code FU1104

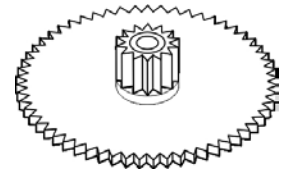

## FUNAI BEARING ASSEMBLY

Original 8059-11-302  
Part No  
Code FU1302

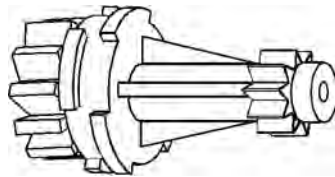

## FUNAI CAM ASSEMBLY

Original 8059-11-303  
Part No  
Code FU1303

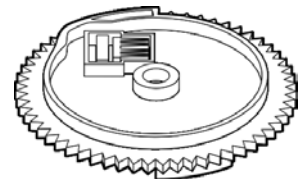

## FUNAI LOADING PULLEY

Original 8059-11-03  
Part No  
Code FU1103

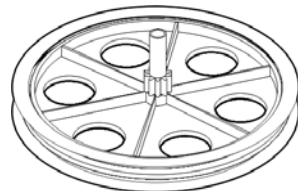

## FUNAI BRAKE RUBBER DAMPER

Original 8059-02-23  
Part No  
Suit GENERAL, TEAC etc.  
Code FU223

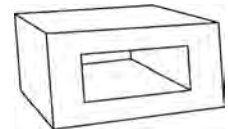

## FUNAI WHEEL ASSEMBLY WORM

Original 8059-16-321  
Part No  
Code FU6321

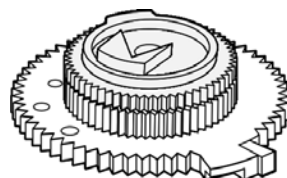

## FUNAI TEAC PALSONIC IDLER & PLATE

Original 62D806509303  
Part No  
Suit MV3010, 3030, 3050, MV4010, 6010, Palsonic VCR9688  
Code GR9303



## FUNAI FRONT LOAD GEAR

Original 8059-16-319  
Part No  
Code FU6319

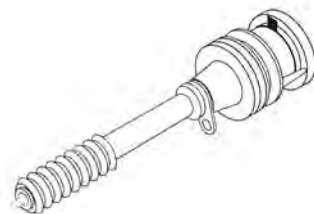

## FUNAI TEAC PALSONIC MAIN GEAR

Original 62D80651104  
Part No  
Suit MV3010, 3030, 3050, MV4010, 6010, Palsonic VCR9688  
Code GR1104



## FUNAI LOADING GEAR LEFT

Original 8059-03-06  
Part No  
Code FU306

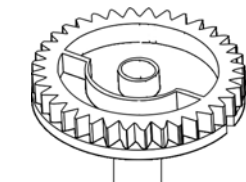

## FUNAI TEAC PALSONIC GEAR CASE

Original 62D806515301  
Part No  
Suit MV3010, 3030, 3050, MV4010, 6010, Palsonic VCR9688  
Code GR5153

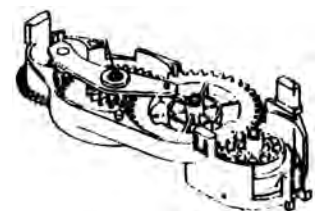



## FUNAI TEAC PALSONIC CLUTCH

Original Part No 62D06509302  
 Suit MV3010, 3030, 3050, MV4010, 6010, Palsonic VCR9688  
 Code VIA9302

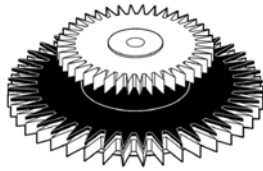

## FUNAI TEAC LOADING ARM SUPPLY

Original Part No OVSA-04215  
 Suit MV3410 MV4810T  
 Code ARM4215

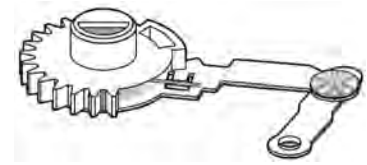

## FUNAI TEAC PALSONIC CAM GEAR

Original Part No 62D806511302  
 Suit MV3010, 3030, 3050, MV4010, 6010, Palsonic VCR9688  
 Code MCG1302

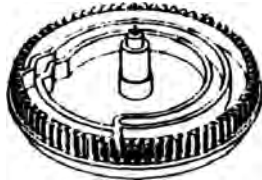

## FUNAI TEAC IDLER

Original Part No OVSA08820  
 Suit MV3420, MV4820.  
 Code VIA8820

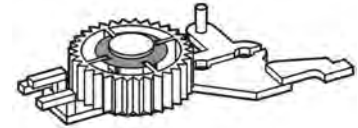

## FUNAI TEAC PALSONIC LOAD SUPPLY

Original Part No 62D806303305  
 Suit MV3010, 3030, 3050, MV4010, 6010, Palsonic VCR9688  
 Code ARM3033



## FUNAI TEAC IDLER CLUTCH

Original Part No OVSA08859  
 Suit MV3420, MV4820.  
 Code VIA8859

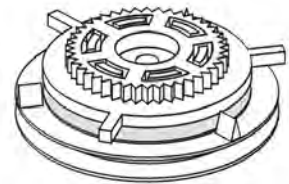

## FUNAI TEAC PALSONIC LOAD TAKE-UP

Original Part No 62D806503305 OVSA-05503  
 Suit MV3010, 3030, 3050, 4010, MV3410, 4810, 6010, Palsonic VCR9688  
 Code ARM5033 ARM5503

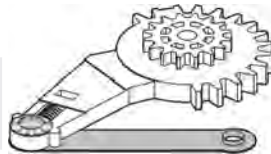

## FUNAI TEAC LOAD ARM SUPPLY

Original Part No OVSA08818  
 Suit MV3420, 4820.  
 Code ARM8818

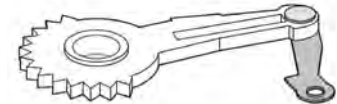

## FUNAI TEAC PALSONIC MAIN BRAKE T/U

Original Part No 62D806510301  
 Suit MV3010, 3030, MV3050, 4010, MV6010, 6010G, VCR9688, etc.  
 Code MBA0301

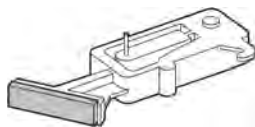

## FUNAI TEAC LOAD ARM T/U

Original Part No OVSA08858  
 Suit MV3420, 4820.  
 Code ARM8858

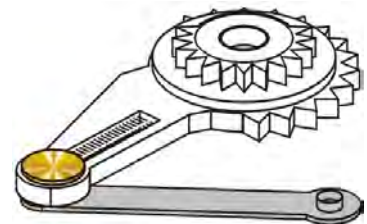

## FUNAI TEAC PALSONIC MAIN BRAKE SUPPLY

Original Part No 62D806510302  
 Suit MV3010, 3030, MV3050, 4010, MV6010, 6010G, VCR9688, etc.  
 Code MBA0302

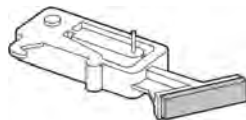

## LG / Goldstar / NEC / Teac

## LG GOLDSTAR COMPLETE ASSEMBLY

Original Part No 321-149B  
 Code VIA1149



## FUNAI TEAC IDLER ASSEMBLY

Original Part No OVSA-06334  
 Suit MV3410 MV4810T  
 Code VIA6334

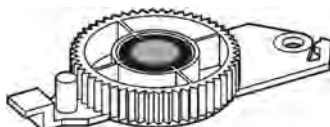

## LG GOLDSTAR IDLER ONLY

Original Part No 386-075A  
 Code VIA6075

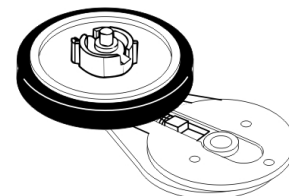





## LG GOLDSTAR COMPLETE ASSEMBLY

Original Part No 321-149B  
Code VIA1149

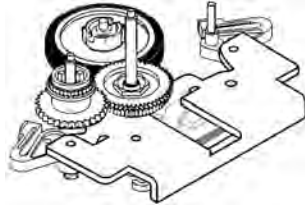

## LG GOLDSTAR GEAR ASSEMBLY

Original Part No 433-015A  
Code GR3015

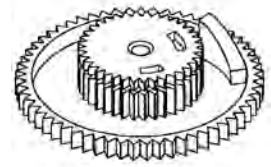

## LG GOLDSTAR IDLER ONLY

Original Part No 386-075A  
Code VIA6075

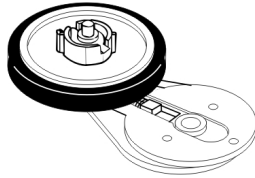

## LG GOLDSTAR CAM GEAR

Original Part No 435-042B/A  
Suit GHV51, GHV1232, GHV1246, GHV1246, etc.  
Code GR5042

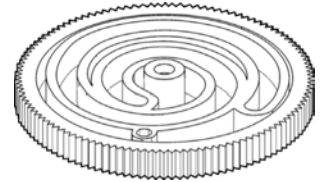

## LG GOLDSTAR COMPLETE ASSEMBLY

Original Part No 321-256A  
Code VIA1256

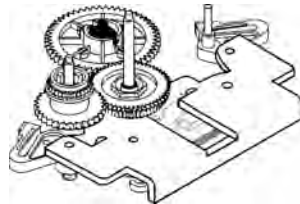

## LG GOLDSTAR GEAR

Original Part No 435-047A  
Suit GHV1240  
Code GR5047

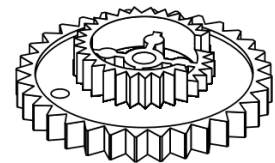

## LG GOLDSTAR IDLER ONLY

Original Part No 386-139A  
Code VIA6139

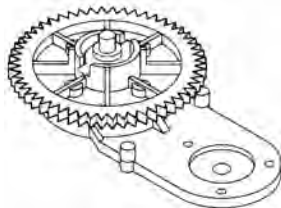

## LG GOLDSTAR GEAR ASSEMBLY

Original Part No 435-054A  
Code GR5054

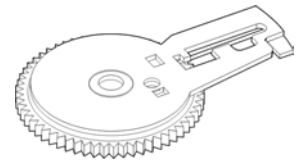

## LG GOLDSTAR COMPLETE ASSEMBLY

Original Part No 321-218A  
Code GR1218

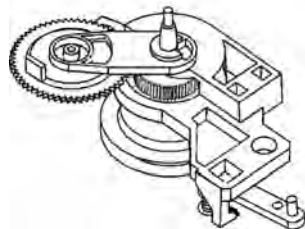

## LG GOLDSTAR CENTRE UNIT

Complete assembled unit  
Original Part No 321-369A  
Suit VCP100  
Code MEC1369

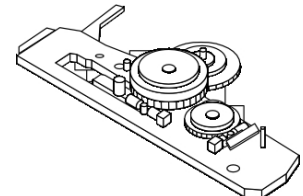

## LG GOLDSTAR IDLER ONLY

Original Part No 431-021A  
Code VIA1021

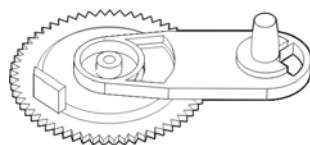

## LG GOLDSTAR PULLEY CENTRE

Original Part No 432-021A  
Code PC4320

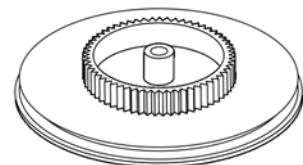

## LG GOLDSTAR CLUTCH

Original Part No 432036A  
Code GR2036

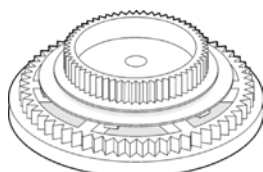

## LG GOLDSTAR MECHANISM PLATE

Plate & idler  
Original Part No 256-218B  
Code MEC2562

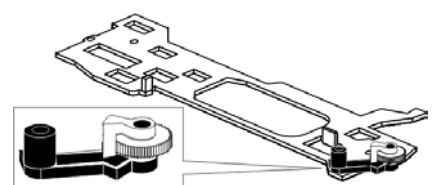



## LG GOLDSTAR GEAR

Original Part No 435-132A Subs  
435-169A 435-146A  
435-053A  
Suit AV65,GHV1296,  
VCR8000  
Code GR5132

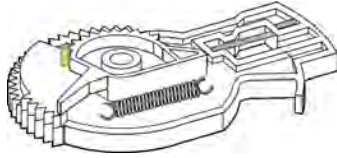

## LG GOLDSTAR IDLER ASSEMBLY

Original Part No 337-005A  
Suit AV66, RG20, RA21H.  
Code VIA7005

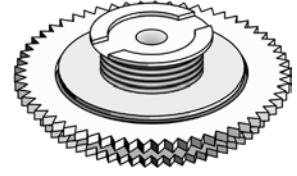

## LG GOLDSTAR MECH

Original Part No 321-397C  
Suit AV66, RG20  
Code MEC1397

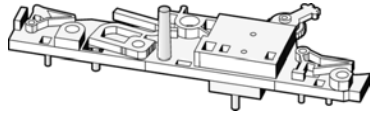

## LG GOLDSTAR IDLER

Original Part No 386-197A  
Suit VCP100, 101, VCP105,  
106, VCP111, 115.  
Code VIA6197

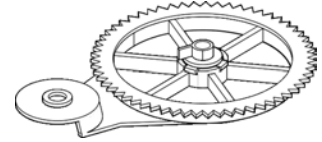

## LG GOLDSTAR DOOR OPENER

Original Part No 465-006A  
Code GS5006

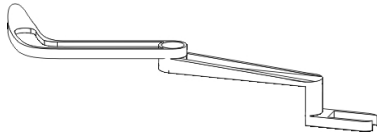

## LG GOLDSTAR CLUTCH ASSEMBLY

Original Part No 435-038A  
Code VXP0600

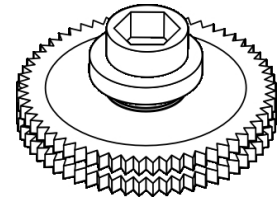

## LG GOLDSTAR DOOR OPENER

Original Part No 465-018A 465-007A  
Code GS5018

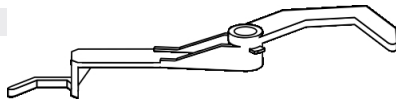

## LG GOLDSTAR GEAR HOUSING

Original Part No 321-232A  
Suit GVH1290,  
1291, GHV1296, 1910.  
Code MEC3212

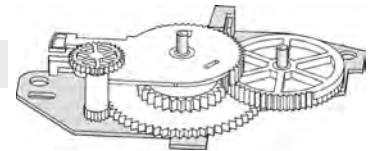

## LG GOLDSTAR MODE CAM GEAR

Original Part No 374-003A  
Code MCG3740

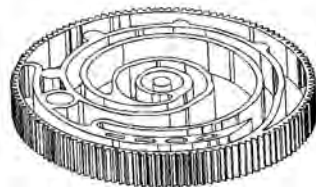

## LG GOLDSTAR / TEAC AUTO HEAD CLEANER

Original Part No 386-296A 386-296C  
Code RL6296

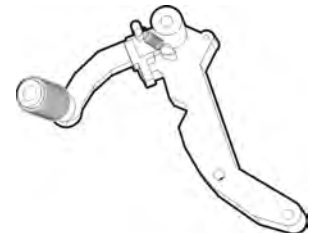

## LG GOLDSTAR LEVER & PINCH GEAR KIT

Original Part No 333-206A 435-245A  
Suit AV66, RG20  
Code KIT5245

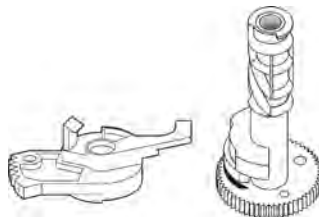

## LG GOLDSTAR GEAR DRIVE

Original Part No New 435-104A Old  
435-055A  
Suit GHV1232 GHV1240  
GHV1246 and others...  
Code GR5104



## LG GOLDSTAR GEAR

Original Part No 433-023A  
Suit AV66, RG20  
Code GR3023

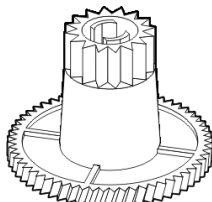

## LG GOLDSTAR / NEC CAM GEAR

Original Part No 435-433A NEC  
79VG1047 VN36  
P23H, P433H,  
P933H, RN800H,  
RN830H, T293H,  
T493H, VHG104,  
VNG67.  
Code GR5433





## LG GOLDSTAR / NEC CAM GEAR

Original Part No 435-441A NEC  
79VG1055 VN36  
P23H, P433H,  
P933H, RN800H,  
RN830H, T293H,  
T493H, VHG104,  
VNG67.  
Code GR5441

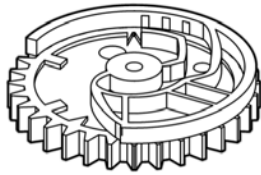

## LG GOLDSTAR / NEC CLUTCH TAKE-UP

Original Part No 337-008A  
VN36, VNG67,  
VHG104, 5, 6, and  
more!  
Code GR7008

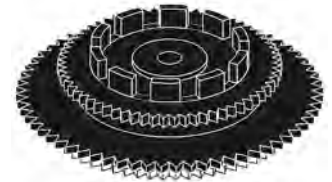

## LG GOLDSTAR / NEC WORM GEAR

Original Part No 437-020A NEC  
79VG1063 VN36  
P23H, P433H,  
P933H, RN800H,  
RN830H, T293H,  
T493H, VHG104,  
VNG67.  
Code GR7020

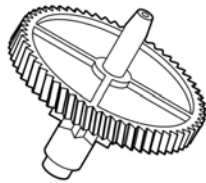

## LG GOLDSTAR CAM GEAR

Original Part No 4470R-0022A  
W903H  
Code GR4470

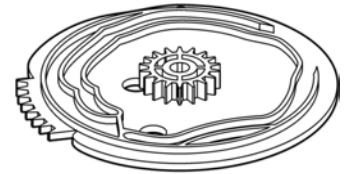

## LG GOLDSTAR / NEC LOAD GEAR

Original Part No 435-437A NEC  
79VG1051 VN36  
P23H, P433H,  
P933H, RN800H,  
RN830H, T293H,  
T493H, VHG104,  
VNG67.  
Code GR5437

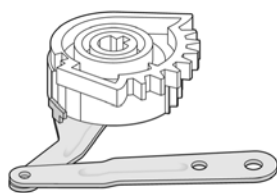

## LG GOLDSTAR / NEC HEAD CLEANER

Original Part No 386-394A NEC VN36  
P23H, P433H,  
P933H, RN800H,  
RN830H, T293H,  
T493H, VHG104, VNG67.  
Code ARM6394

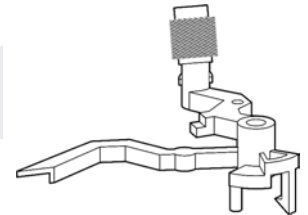

## LG GOLDSTAR / NEC LOADING GEAR SUPPLY

Original Part No 435-435A NEC  
79VG1049 VN36  
P23H, P433H,  
P933H, RN800H,  
RN830H, T293H,  
T493H, VHG104,  
VNG67.  
Code GR5435

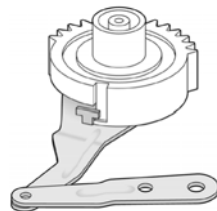

## LG GOLDSTAR HEAD CLEANER

Original Part No 4261R0003A  
AF293, 493,  
993, AC250, 450,  
950.  
Code ARM0003



## LG GOLDSTAR / NEC IDLER

Original Part No 386-396A NEC  
79VG1031 VN36  
P23H, P433H,  
P933H, RN800H,  
RN830H, T293H,  
T493H, VHG104,  
VNG67.  
Code GIA6396

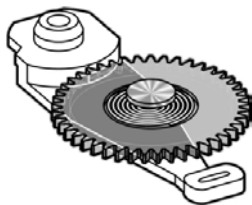

## LG GOLDSTAR IDLER ARM

Original Part No 4261R0008A  
AF293 AC250 Akai  
VSJ200 VSJ215  
Code VIA0008

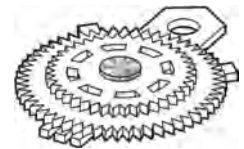

## LG GOLDSTAR / NEC GEAR P/S

Original Part No 435-442A NEC 79VG1031  
VN36  
P23H, P433H,  
P933H, RN800H,  
RN830H, T293H,  
T493H, VHG104, VNG67.  
Code GR5442

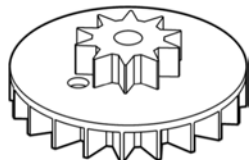

## LG GOLDSTAR IDLER ARM

Original Part No 4261R0009A  
AF493, 993, AC450,  
950, Akai VSJ411,  
416, VSJ700,  
711, VSJ716, only.  
Code VIA0009

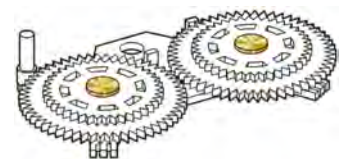

## LG GOLDSTAR / NEC CLUTCH SUPPLY

Original Part No 337-007B  
VN36, VNG67,  
VHG104, 5, 6, and  
more!  
Code GR7007

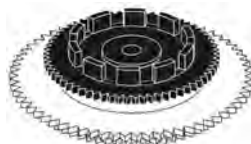

## LG GOLDSTAR LOAD ARM SU

Original Part No 4470R0026A  
AF293, 493,  
993, AC250, 450,  
950.  
Code ARM0026

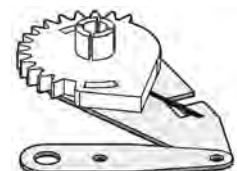





# Video Repair Parts

## LG GOLDSTAR LOADING MOTOR / BRACKET

Original Part No 4811R0011A  
 Suit AF293, 493, 993, AC250, 450, 950.  
 Code VM0011



## LG GOLDSTAR LOAD SHAFT

Original Part No 1261R0010A  
 Suit AF293, 493, 993, AC250, 450, 950.  
 Code ARM0010



## LG GOLDSTAR DRIVE GEAR

Original Part No 4470R0005A  
 Suit AF293, 493, 993, AC250, 450, 950.  
 Code GR0033

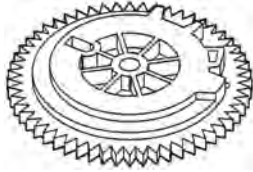

## LG GOLDSTAR UP / DOWN GEAR

Original Part No 4470R0044A  
 Suit AF293, 493, 993, AC250, 450, 950.  
 Code GR0044

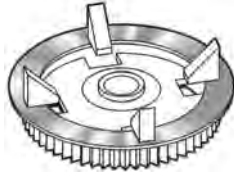

## LG LOADING ARM

Original Part No 4471R-0015A  
 Suit V8844W  
 Code ARM0015



## LG LOADING ARM

Original Part No 4471R-0017A  
 Suit V8824W  
 Code ARM0017



## GRUNDIG

SEE JVC (Early) & PANASONIC  
 e.g. GV469M = "K" Mech'



VS940VPT = NVF65 Except for different Cassette Housing.

## Hitachi

### HITACHI IDLER ASSEMBLY

Original Part No 6886971  
 Suit VT11.  
 Code VIA155

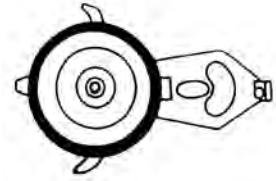

### HITACHI TYRE DRIVE IDLER

Original Part No 6889931  
 Suit VT11, 17, 168  
 Code VIA160



### HITACHI IDLER ASSEMBLY

Original Part No 6886792  
 Suit VT100, 120, VT130, etc.  
 Code VIA145

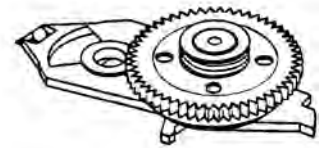

### HITACHI CLUTCH ASSEMBLY

Original Part No 6804834  
 Part No 6896954  
 Suit VTM728  
 Code MEC4834

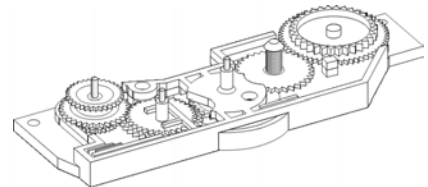

### HITACHI MECHANISM

Suit VTM740  
 Code MEC7874

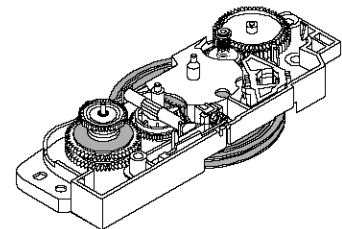

### HITACHI CLEANING ROLLER

Original Part No 7472125  
 Suit VTM598E  
 VTM838E  
 Code RL2125

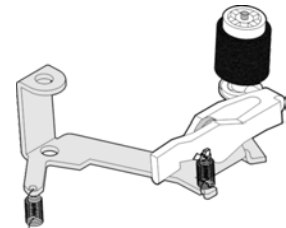

### HITACHI IDLER ASSEMBLY

Original Part No 6861505  
 Code VIA116

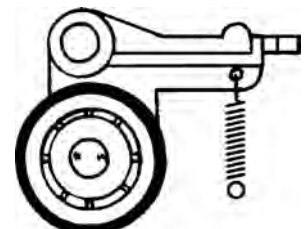





## HITACHI COG DRIVE IDLER

Original 6886824  
 Part No  
 Suit VT138,20E  
 Code VIA150

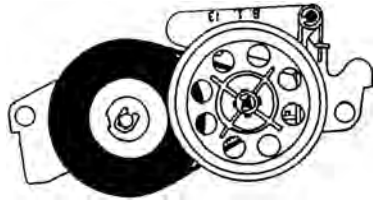

## JVC IDLER ARM

Suit HR2650 HR2200  
 (3mm shaft) (4mm)  
 Code PU52190A PU48811D

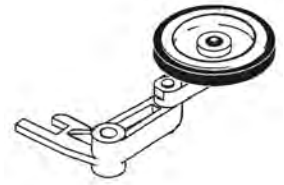

## HITACHI LOADING GEAR LEFT

Original 7429651  
 Part No  
 Suit VTM598  
 VTM838  
 Code GR9651

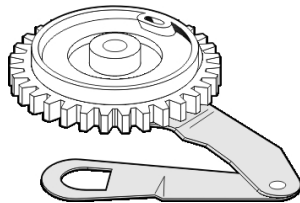

## JVC TAKE-UP CLUTCH

Suit HRD110,  
 HRD120,  
 HRD125,  
 etc.  
 Code PU55373



## HITACHI LOADING GEAR RIGHT

Original 7429661  
 Part No  
 Suit VTM598, 728,  
 VTM818, 838  
 Code GR9661

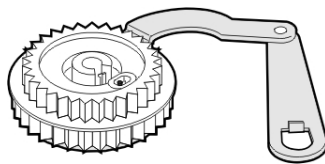

## JVC TAKE-UP CLUTCH

Suit HR3300,  
 HR3330,  
 HR3660,  
 HR4100,  
 HR4110, etc.  
 Code PU47752

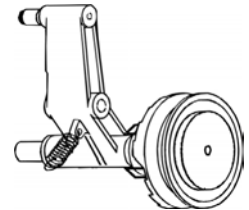

## HITACHI MECHANISM

Original 7794876 Old  
 7794873 With  
 7794931  
 Suit VTM748E  
 Motor, Switch,  
 Slide plate,  
 etc.  
 Code MEC4876

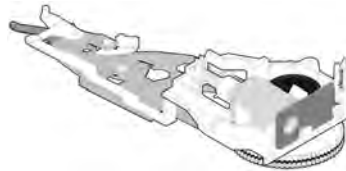

## JVC IDLER ASSEMBLY

Original PU48967B  
 Part No  
 Code VIA216

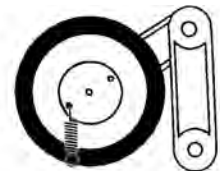

## HITACHI BRACKET FL (R)

### CASSETTE LOADER RIGHT

Original 6804982  
 Part No 6804987  
 Suit VTM598, 728,  
 VTM748, 818,  
 VTM838, etc.  
 Code MEC4982

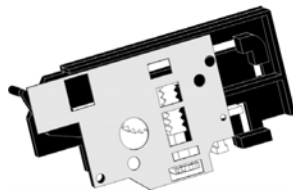

## JVC TAKE-UP CLUTCH

Suit HR7200 etc.  
 Code PU53462A

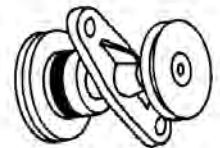

## JVC

### JVC IDLER ASSEMBLY

Original PU46381  
 Part No  
 Suit HR3300,3330,  
 HR3660,4100  
 Code VIA210

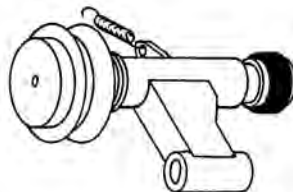

### JVC IDLER ASSEMBLY

Original PU55374-3-8  
 Part No  
 Suit HRD110,  
 GE8100  
 N830,  
 RV360.  
 Code VIA236

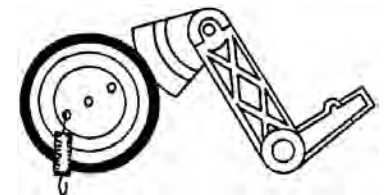

### JVC TAKE-UP CLUTCH

Suit HR3330,  
 HR3660  
 Code PU49280

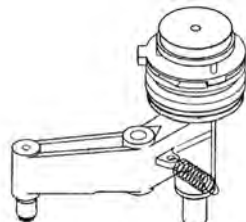

### JVC IDLER ASSEMBLY

Original PU51402A  
 Part No  
 Suit HR7200,7300,  
 HR7600,7650,  
 HR7655,D110,D111  
 HRD120,D121,D225,  
 N830, etc  
 Code VIA228

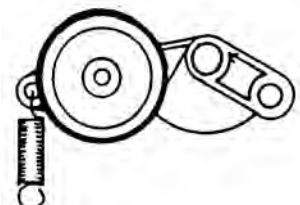



## JVC IDLER

Original PU61004-1-3  
 Part No  
 Suit HR-D540 HR-D580  
 Code PU61004

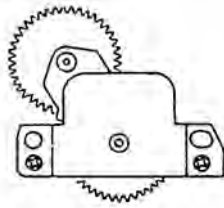

## JVC CLUTCH UNIT

Original PU60953-1-2  
 Part No  
 Suit HRD520, 521, HRD600, 610, HRD620, 830, HRDX20, 22, etc.  
 Code PU60953

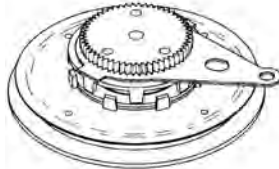

## JVC IDLER

Original PU58645-1-4  
 Part No  
 Suit HR-D series.  
 Code VIA240

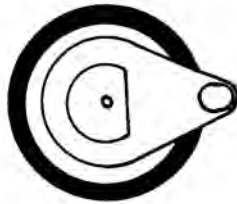

## JVC AIR DAMPER

Suit HR7200  
 Code PU51252

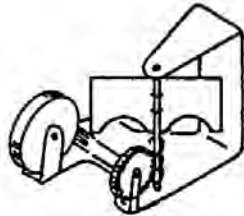

## JVC CLUTCH UNIT

Original PU61005-1-4  
 Part No  
 Suit HR-D540 HR-D580  
 Code PU61005

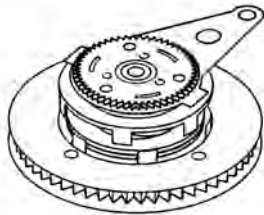

## JVC MECHANISM

Original PU57658B-6  
 Part No  
 Suit HR-D series.  
 Code MEC658



## JVC CLUTCH MECH. ASSEMBLY

Original PU55822A-10  
 Part No  
 Equiv. PU55822A-8  
 Suit HRD455, 725.  
 Code PU55822

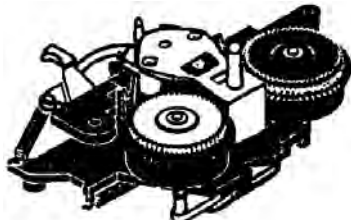

## JVC PINCH ROLLER LIFTER

Suit HRD520, 640, 830, HRDS5000, HRDX20, VR3241, 3275 and others.  
 Code PQ32415



## JVC DRIVE GEAR ASSEMBLY

Suit HR7600, HR7650  
 Code PU51859A-2

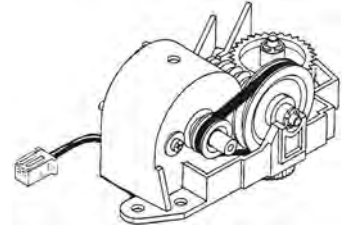

## JVC DRIVE GEAR ASSEMBLY

Suit HRD110, HRD111, HRD120, HRD121.  
 Code PU51859C-11

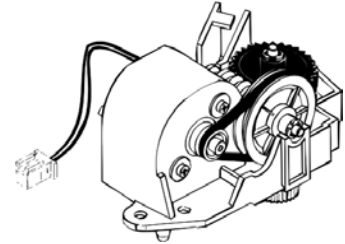

## JVC DRIVE GEAR ASSEMBLY

3 pin connector.

Suit HRD455, 725 and others 3 pin connector.  
 Code PUS36689V

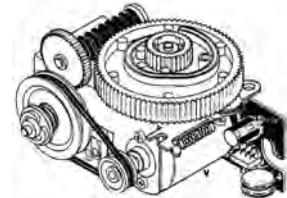

## JVC DRIVE GEAR ASSEMBLY

2 pin connector.

Suit HRD455, HRD725, HRD755.  
 Code PUS36689X

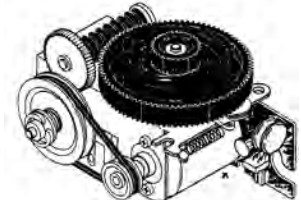

## JVC DRIVE GEAR ASSEMBLY

2 pin connector.

Suit HRD158, HRD160, 257, etc.  
 Code PUS36689W

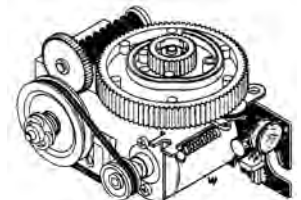

## JVC IDLER GEAR UNIT

Original PU60618-1-3  
 Part No  
 Suit HRD520, 521, 525, 600, 830, X20, etc.  
 Code PU60618

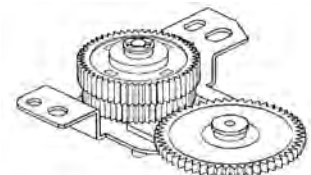



## JVC PLATE ASSEMBLY

Suit HRD637, 825,  
HRDX20, X22,  
X24, X42,  
HRDJ400, 415,  
615  
Code PQ43555C10

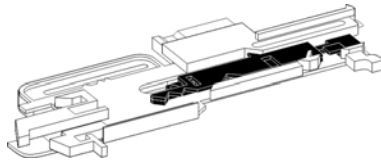

## JVC PLATE ASSEMBLY

Suit HRD540 HRD92  
Code PQ44326A-3



## JVC ROLLER BAR

Suit HR7650, 7700 etc.  
Code PU49042A



## JVC "GEAR-1"

Found in PUS26805U  
cassette housing

Suit HRD120, 140,  
HRD141, 142,  
HRD143, etc.  
Code PQ40059

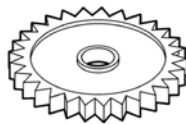

## JVC "GEAR-2"

Suit NEC N830,  
Toshiba V55 JVC  
HRD120,140,141,  
142,143,150,225,  
250,565,725,etc...  
Code PQ40060



## JVC GEAR

Suit PUS26805  
cassette housing.

Suit HRD120, 140,  
HRD141, 142,  
HRD143, 150, HRD225,  
etc.  
Code PQ40065

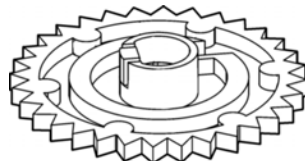

## JVC CAM GEAR

Suit PUS26805  
cassette housing.

Suit HRD150,225,  
HRD250,265,  
HRD565,725, & MORE.  
Code PQ30028



## JVC LIMITER SPRING

Fits between  
PQ30028 & PQ40066

Suit HRD110,120,140,150,220,250,455  
,565,725,755, N382,830,831,895,  
MV800,RV360,380,  
GE8100,V55,V63, VR2925,2970  
Code PQ40068-2



## JVC LOAD GEAR

Suit PUS26805  
cassette housing.

Suit HRD120,140,  
HRD141,142,  
HRD143,150,  
HRD225, etc.  
Code PQ40066



## JVC SLIDE GEAR

Suit PUS26805  
cassette housing.

Suit HRD150,225,  
HRD250,265,  
HRD565,725,  
& MORE.  
Code PQ40067

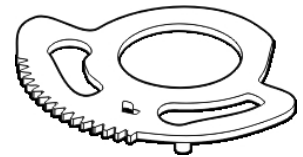

## JVC LOADING GEAR 2

Original Part No PQ30193-1-2  
Suit HRD140,150,  
250,455,  
565,725, 755,  
N895, etc...  
Code PQ30193

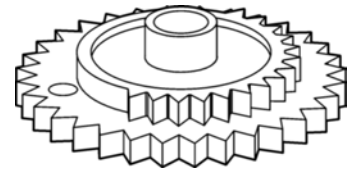

## JVC DOOR OPENER

Suit PUS26805  
cassette housing.

Suit HRD150,225,  
HRD250,265,  
HRD565,725,  
& MORE.  
Code PQ40074



## JVC GUIDE ARM

Suit HRD520,600,  
HRD825,830,  
HRDX20,X22  
Code PQ43567A-13

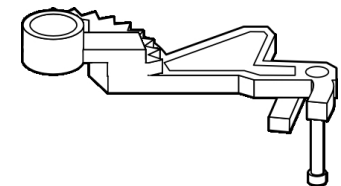

## JVC H.LOADING GEAR

Suit HRD520,600,  
HRD825,830,  
HRDX20,X22  
Code PQ43570B

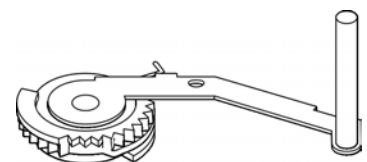





## JVC LOADING ARM

Suit HRD540, 580,  
HRD640, etc.  
HRJ200, etc.

Code PQ43537B

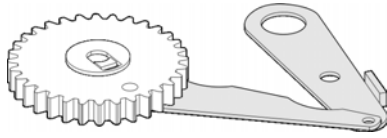

## JVC LOADING ARM

Suit HRD540, 580,  
HRD640, etc.  
HRJ200, etc.

Code PQ43542D-4

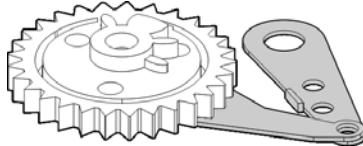

## JVC LOADING ARM

Suit HRJ220, 221,  
HRJ625, etc.

Code PQ46332A-3

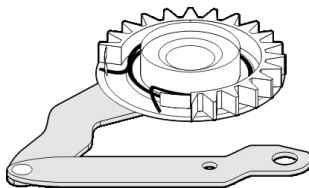

## JVC TENSION ARM

Original Part No PQ46303A-8, 4822  
4037 1294

Suit HRJ220, 221, 425,  
435, HRJ621, 625,  
635, etc. VR155,  
357, 455, VR656 and  
more.

Code PQ46303A

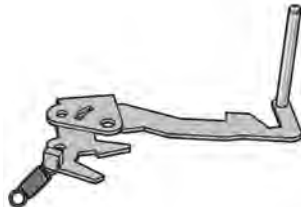

## JVC TENSION ARM LEVER

Original Part No PQ35012-1-5 4822  
4021 0367

Suit HRJ220, 221, 425,  
435, HRJ621, 625,  
635, etc. VR155,  
357, 455, VR656 and  
more.

Code PQ35012

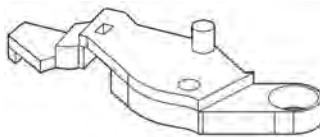

## JVC GUIDE ARM

Suit HRJ220, 221,  
HRJ625, etc.

Code PQ46325B



## JVC PULLEY

Suit HRJ220, 221,  
HRJ625, etc.

Code PQ35016-1-3

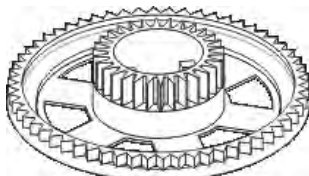

## JVC POLE BASE (T)

Suit HRD910 HRJ200  
HRJ400 etc...

Code PU61103-2-7

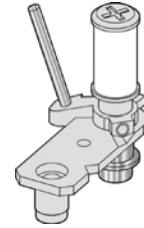

## JVC POLE BASE (S)

Suit HRD910 HRJ200  
HRJ400 etc...

Code PU61151-2-7

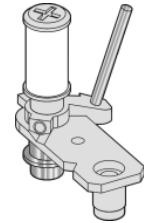

## JVC GEAR UNIT

Suit HRD640

Code PU61246-1-5



## JVC CLUTCH

Suit HRD640

Code PU61245-1-3

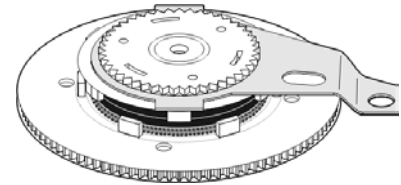

## JVC CONTROL CAM

Suit HRD520,600,  
HRD825,830,  
HRDX20,X22

Code PQ20822-2-7

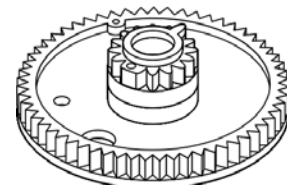

## JVC TENSION SPRING

Code PQ43500



## JVC LOADING ARM TAKE-UP

Suit HRD230, 320,  
HRD370, 430

Code PQ41985B-3

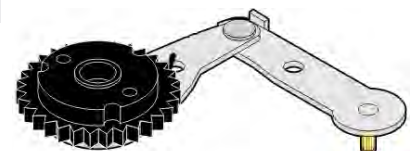





## JVC LOADING ARM SUPPLY

Suit HRD230,  
320,  
HRD370,  
430  
Code PQ41979A-5

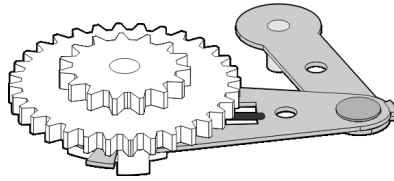

## JVC CAM GEAR UNIT

Suit HRJ600  
Code PU61389

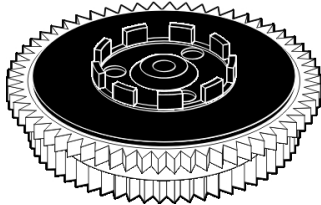

## JVC IDLER

Suit HRJ600  
Code PU61390

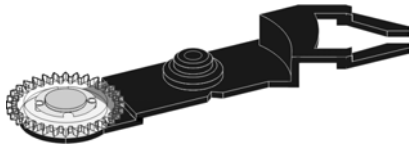

## JVC CAM GEAR UNIT

Suit HRJ600  
Equiv. PU61317-1-3  
Code PU61317-1-4

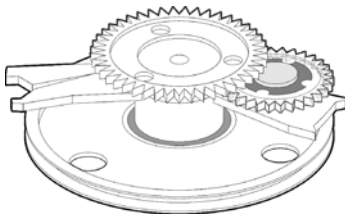

## JVC CLUTCH GEAR UNIT

Suit HRJ600  
Equiv. PU61388-1-3  
Code PU61388-2

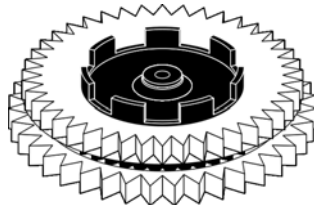

## JVC CENTRAL CAM

Suit HRJ600  
Code PQ11649-1-3

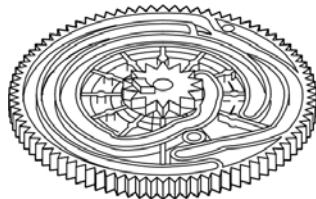

## JVC CONTROL PLATE

Suit HRJ220, 221,  
HRJ625, etc.  
Code PQ11658-1-15

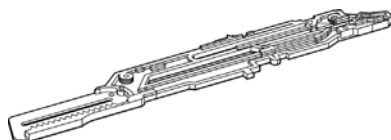

## JVC CAM GEAR

Original Part No PQ20250-1-1  
Suit HRD170,  
HRD180,  
HRD530  
Code PQ20250

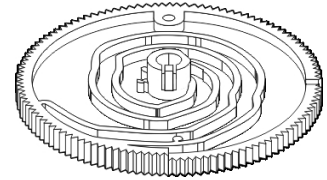

## JVC SUPPLY POLE

Complete kit  
Suits many late  
models.

Code PTU96102E

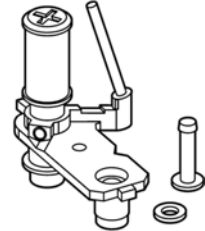

## JVC STOPPER BLACK

Suit Tape Loading (S) Pole  
Base PQ61151-2-7 From  
Kit PTU96102E

Suit HRD540,830,  
HRD910,etc..  
HRJ200,etc..  
Code PQ45894



## JVC TAKE-UP POLE

Complete kit Suits  
many late models.

Code PTU96103E

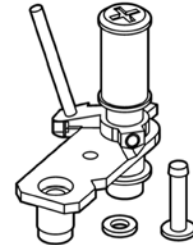

## JVC STOPPER WHITE

Suit Tape Loading (T)  
Pole Base PQ61103-2-7  
From Kit PTU96103E

Suit HRD540,830,  
HRD910,etc..  
HRJ200,etc..  
Code PQ45895



## WASHER TO SUIT "STOPPERS" ABOVE

Code PQM30017-41

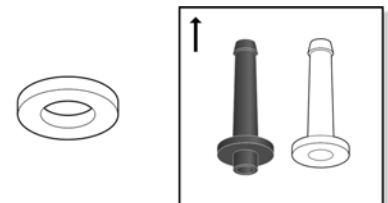

## JVC SLIDE PLATE

Original Part No 4822 4668  
3023

Suit HRD910,  
VR253,  
VR454, etc.  
Code PQ44581B

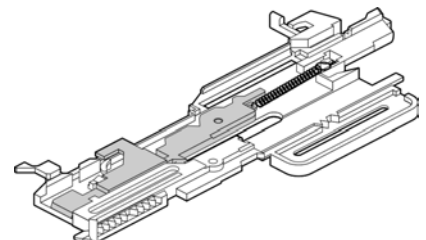



# Video Repair Parts

## JVC CHANGE GEAR

Suit HRJ220, 221,  
HRJ625, etc.  
Code PQ46354

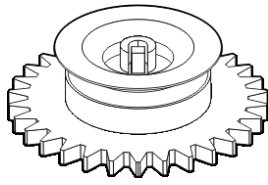

## JVC IDLER ARM

Suit HRJ220, 221,  
HRJ625, etc.  
Code PQ46312B-8

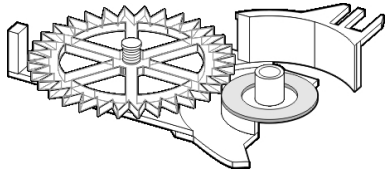

## JVC CLUTCH ASSEMBLY

Suit HRJ220, 221,  
HRJ625, etc.  
Code PQ46323A-1

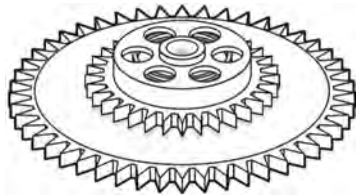

## JVC LEVER METAL

Original Old PQ46342A-6  
New PQ46342C-9  
Part No Philips 402240371302  
482240210387  
Suit HRJ425, 635, etc.  
VR555-75, etc.  
Code PQ46342

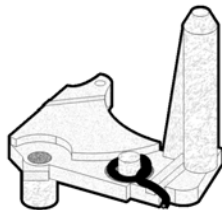

## JVC LOADING ARM

Suit HRJ220,221, HRJ625,etc  
Code PQ46337A-7

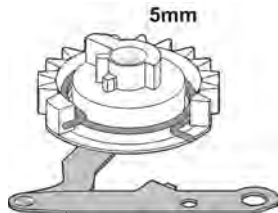

Only one type of arm in JVC  
Beware - There are two types  
used in Philips, See below !

## JVC/PHILIPS LOADING ARM - TAKE 2

Original Philips 4822-402-10625,  
Part No Many models.  
Code ARM625

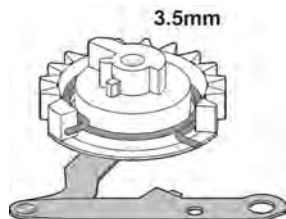

This gear has a smaller hole !  
Beware - There are two types  
used in Philips, See above !

## JVC CONTROL CAM

Suit HRJ220, 221,  
HRJ625, etc.  
Code PQ21684-1-3

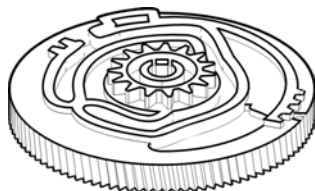

## JVC HEAD CLEANER

Suit HRJ600, etc.  
Code PQ44840B-5

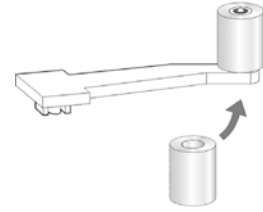

## CLEANER ROLLER ONLY

Code PQ44837

## JVC HEAD CLEANER

Suit HRJ400  
Code PQ46019



## JVC CLEANER

Suit HRJ220,  
HRJ221,  
HRJ625  
Code PQ46419



## JVC CHANGE ARM ASSEMBLY

Original PQ46353A-1  
Part No PQ46353A-2  
HRJ425, 435,  
HRJ625, 635,  
Suit VR255, 455,  
456, VR555,  
655, 755  
Code PQ46353

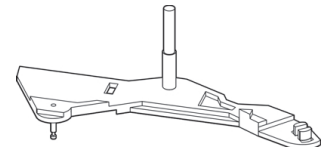

## JVC IDLER ARM

Original LP40114-002D  
Part No LP40114-004A  
4822-402-11053  
Suit HRJ255, 455,  
HRJ655, 755.  
VR288, 388.  
Code ARM4002



## JVC CLUTCH UNIT

Original LP40115-002C/D  
Part No 4822-522-10701  
Suit HRJ255, 455,  
HRJ655, 755.  
VR288, 388.  
Code VIA5002

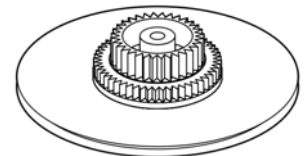

## JVC TENSION BRAKE

Original LP40109-003D  
Part No 4822-402-11056  
Suit HRJ255, 455,  
HRJ655, 755.  
VR288, 388.  
Code TB9002





## JVC CAM GEAR

Original LP30229-001B  
Part No LP30229-002F  
Suit HRJ255, 455,  
HRJ655, 755.  
Code MCG9001



## JVC LIMIT GEAR 2

As above but black  
Code GR9004

Colour Supplied May Vary.  
(stock is grey)



## JVC CAM GEAR

Original 4822-528-11256  
Part No  
Suit VR288, 388,  
VR588, 788,  
VR888, 988.  
Code MCG9002



## JVC LOAD ARM TAKE-UP

Original LP40103-002B  
Part No 4822-402-11063  
Suit HRJ255, 455,  
HRJ655, 755.  
VR288, 388.  
Code GR3002

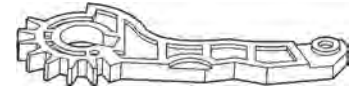

## JVC DIRECT GEAR

Original LP40122-001A,  
LP40122-002A,  
Part No LP30463-002A  
4822-522-10699  
Suit HRJ255, 455,  
HRJ655, 755.  
VR288, 388.  
Code GR2001



## JVC LOADING ARM SUPPLY

Original LP30224-001A  
Part No 4822-402-11063  
Suit HRJ255, 455,  
HRJ655, 755.  
VR288, 388.  
Code GR3003

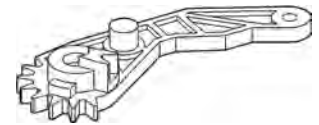

## JVC CLEANER

Original LP40369-001B/D  
Part No PQ46418-1-2  
4822-528-11247  
Suit HRJ255, 455,  
HRJ655, 755.  
VR288, 388.  
Code ARM9001



## JVC DRIVE GEAR

Original LP30243-001B/C  
Part No 4822-522-10702  
Suit HRJ255, 455,  
HRJ655, 755.  
VR288, 388.  
Code GR3004



## JVC SLIDE PLATE

Original LP10080-002E/F  
Part No 4822-466-11932  
Suit HRJ255, 455,  
HRJ655, 755.  
VR288, 388.  
Code PSM0002



## JVC RELAY GEAR

Original LP30242-001A  
Part No LP30242-002A  
4822-522-10703  
Suit HRJ255, 455,  
HRJ655, 755.  
VR288, 388.  
Code GR3005



## JVC LIMIT GEAR 1

Original LP30239-002E/F  
Part No 4822-522-10704  
Suit HRJ255, 455,  
HRJ655, 755.  
VR288, 388.  
Code GR9003

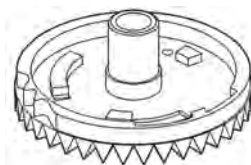

## JVC CASSETTE GEAR

Original LP30237-002A/B  
Part No 4822-522-10698  
Suit HRJ255, 455,  
HRJ655, 755.  
VR288, 388.  
Code GR7002

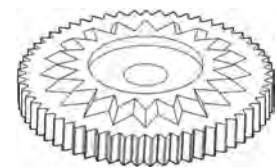

## JVC LIMIT GEAR 2

Original LP30240-002C/G,  
Part No 4822-522-10705  
Suit HRJ255, 455,  
HRJ655, 755.  
VR288, 388.  
Code GR9004

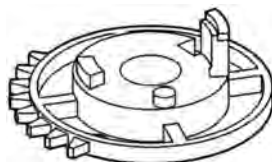

## JVC CLEANING ARM

Original PQ46436A-1  
Part No  
Equiv. PQ46418-1-2  
Suit HRJ425  
Code PQ46436

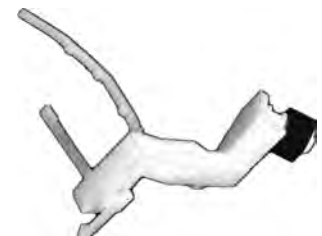

Colour Supplied May Vary. (stock is grey)



## JVC TAKE-UP LEVER

Original Part No PQ21686-1-3  
 Suit HRJ615  
 Code PQ21686



## MITSUBISHI/AWA GEAR

Original Part No 641D797010  
 Suit AWA AV12 AV400  
 Code GR7970

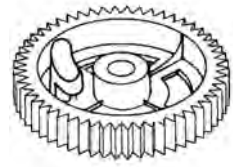

## JVC U-MATIC E. ROLLER ASSEMBLY

Suit CR6060  
 Code PU41155A

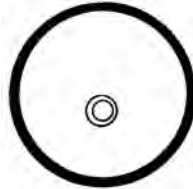

## MITSUBISHI/AWA CAM GEAR (B)

Original Part No 641B094010  
 Suit AWA AV11, 12, 14, 51, 52, AV400, 410, HS306, 307, 318, HS319, 400, 410, TR102  
 Code GR9401



## JVC U-MATIC RING DRIVE ROLLER

Suit CR8300  
 Code PU42645A



## MITSUBISHI DRIVE GEAR

Original Part No 622D227010  
 Suit HS521V,531V,541V, HS551V,581V, HS651V,661V, HSM60V,HSX3, HSX10,20,etc.  
 Code GR2270

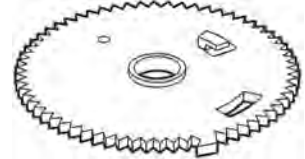

## □ Mitsubishi / AWA

## MITSUBISHI/AWA IDLER

Original Part No 522P002010  
 Suit AV12,14,51 AV52,400,etc.  
 Code VIA910

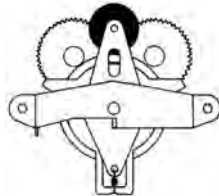

## MITSUBISHI MAIN CAM

Original Part No 641B32301  
 Suit 641B323010  
 Code HSMX1,X2 MCG2301

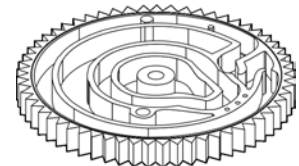

## MITSUBISHI/AWA GEAR

Original Part No 641D799010  
 Suit AV12,51,400, 410,TR102,etc.  
 Code GR7990

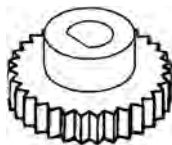

## MITSUBISHI MAIN CAM #2

Original Part No 614B32401  
 Suit 641B324010  
 Code HSMX1,X2 MCG2401

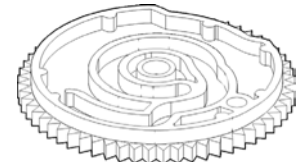

## MITSUBISHI/AWA CAM GEAR (A)

Original Part No 641B093010  
 Suit AWA/Mitsubishi  
 Code GR9301



## MITSUBISHI PINCH CAM

Original Part No 641B31402  
 Suit 641B314020  
 Code HSMX1,X2 CAM1402



## MITSUBISHI IDLER ASSEMBLY

Original Part No 522B01701  
 Suit HS337, HS338, HSE20 etc...  
 Code VIA1701



## MITSUBISHI PINCH CAM

Original Part No 641B63002  
 Suit 641B630020  
 Code HSM50,X3, HSMX5,X7, HSMX10,20.  
 Code CAM3002







## MITSUBISHI "R" CAM

Original Part No 621C23501  
621C235010  
Suit HSM50,X3,  
HSMX5,X7,  
HSMX10,20.  
Code GR5010

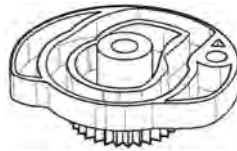

## MITSUBISHI GEAR IDLER

Original Part No 522C07702  
522C077020  
522C07701/0  
Suit HSMX1,X2,  
HSE11,17,  
HSE82,etc.  
Code GIA7702



## MITSUBISHI PINCH CAP

Original Part No 641B62801  
641B628010  
Suit HSM50,X3,  
HSMX5,X7,  
HSMX10,20.  
Code PC2801



## MITSUBISHI CLEANING ROLLER

Original Part No 621C03301  
621C033010  
Suit HSM50,X3,  
HSMX5,X7,  
HSMX10,20.  
Code RL3301

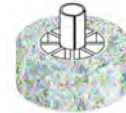

## MITSUBISHI LOADING ARM

Original Part No	592B04701-0	592B04801-0
Suit	HSM50,HSMX3,5,7,10,20	HSM50,HSMX3,5,7,10,20
Code	ARM701	ARM801

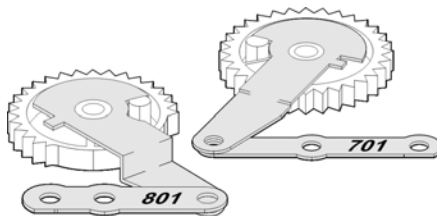

## MITSUBISHI PINCH GEAR

Original Part No 621C24001  
621C240010  
Suit HSM50,X3,  
HSMX5,X7,  
HSMX10,20.  
Code GR4001

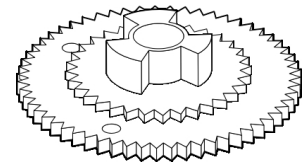

## MITSUBISHI REEL IDLER

Original Part No 522B05703  
522B057030  
522B05701/0  
Suit HSM50,X3,  
HSMX5,X7,  
HSMX10,20.  
Code GIA5703

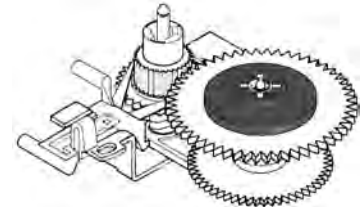

## MITSUBISHI GEAR JOINT

Original Part No 621C257010  
621C25703  
621C257030  
Suit HSM50,X3,  
HSMX5,X7,  
HSMX10,20.  
Code GR5701

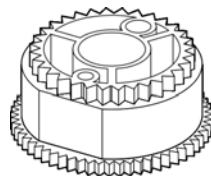

## MITSUBISHI PULLEY WORM

Original Part No 621C25901  
621C259010  
Suit HSM50,X3,  
HSMX5,X7,  
HSMX10,20.  
Code PW5901



## MITSUBISHI GEAR MAIN

Original Part No 641B63702  
641B637020  
641B63701/0  
Suit HSM50,X3,  
HSMX5,X7,  
HSMX10,20.  
Code GR3702

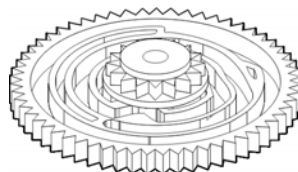

## MITSUBISHI LOAD ARM UNIT [T]

Original Part No 593C826010  
593C826020  
Suit HS521,  
621,HS640,  
7424.  
Code GR6020



## MITSUBISHI CAM PLATE

Original Part No 641A31101  
641A311010  
Suit HSM50,X3,  
HSMX5,X7,  
HSMX10,20.  
Code CP1101

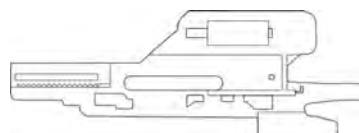

## MITSUBISHI DRIVE GEAR

Original Part No 641B793010  
Suit HS521,  
621,HS640,  
7424.  
Code GR7930

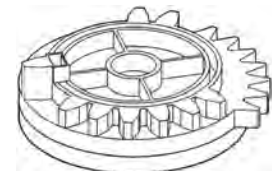



## MITSUBISHI CAM GEAR

Original Part No 641B792010  
 Suit HS521, 621,HS640, 7424.  
 Code GR2010



## MITSUBISHI LOAD WORM GEAR

Original Part No 621C504010  
 Suit HS521, 621,HS640, 7424.  
 Code GR4010



## MITSUBISHI TIME-LAPSE VCR

### PULLY GEAR

Original Part No 641C790010  
 Suit HV5440, HVBZ71, VT35354NBS  
 Code PLY0010

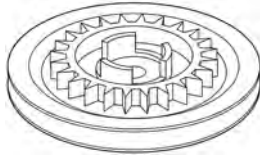

## NEC

## NEC REEL DRIVE ASSEMBLY

Original Part No 16192683  
 Suit 9000 series, DS6000, DX1600, DX3000  
 Code MEC2683

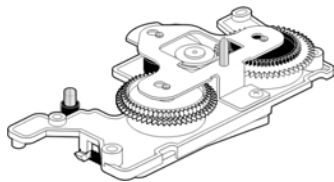

Note: Requires ARM582 (\$3.95 )

## NEC CR SLIDING ARM

Suit N9073 N9401 and other early models. Required when replacing MEC2683 Mech.  
 Code ARM582

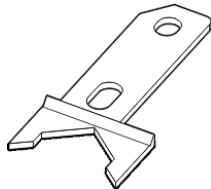

## NEC IDLER PLATE

Original Part No 79TD3955  
 Code VIA3955

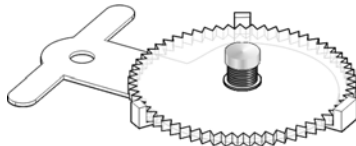

## NEC CAM GEAR

Original Part No 97S2705700  
 Suit VN20  
 Code GR5700

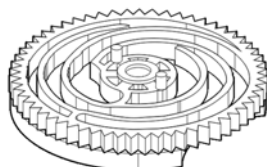

## NEC MECHANISM

Original Part No 97SB335300  
 Suit VN20  
 Code MEC5300

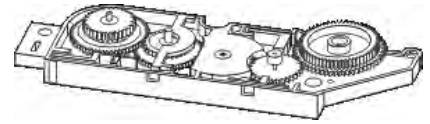

## NEC REEL DRIVE ASSEMBLY

Original Part No 16178173  
 Suit N901, 911  
 Code MEC8179

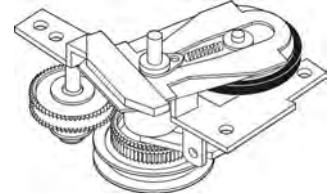

## NEC MODE CAM ASSEMBLY

Inc.Motor.

Original Part No 16185091  
 Suit Late 9000 & DX1600,3000  
 Code MCA5091

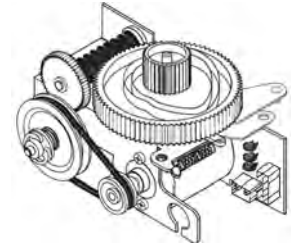

## NEC MODE CAM ASSEMBLY

Original Part No 16179645  
 Suit N901  
 Code MCA9645

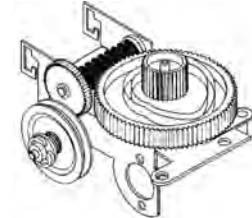

## NEC MODE CAM ASSEMBLY

Inc. Motor.

Original Part No 16179832  
 Suit N911 and Early 9000  
 Code MCA9832

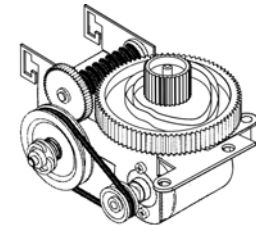

## NEC IDLER ASSEMBLY

Original Part No 16180801  
 Suit N901,911, N912,etc.  
 Code VIA460

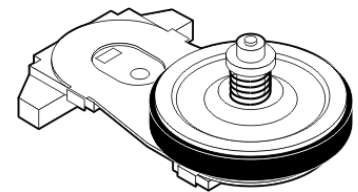

## NEC LOADING GEAR

Original Part No 16443362  
 Suit N901, 911, etc.  
 Code GR3362

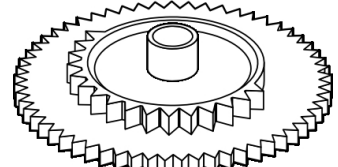



## Orion

### ORION IDLER

Original 850A200026  
 Part No 850A200038  
 Code GIA2026

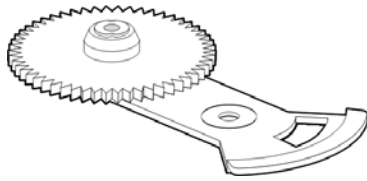

## Panasonic

### PANASONIC IDLER

VXP0243  
 Original NV8400,  
 Part No NV8600,  
 NV8610  
 Code VIA304



### PANASONIC CLUTCH ASSEMBLY

Original VXP0265  
 Part No  
 Code VIA312

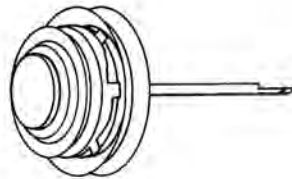

### PANASONIC LOADING PULLEY

Code VDP0985

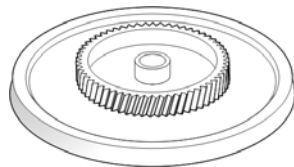

### PANASONIC IDLER

Original VXP0245  
 Part No  
 Suit NV8400,  
 NV8600,  
 NV8610.  
 Code VIA308

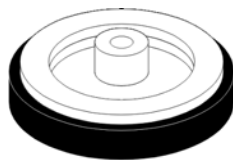

### PANASONIC IDLER

Original VXP0329  
 Part No  
 Suit NV2000  
 NV3000  
 Code VIA316



### PANASONIC IDLER

Original VXP0331  
 Part No  
 Suit NV2000  
 NV3000  
 Code VIA320



### PANASONIC IDLER

Original VXP0344  
 Part No  
 Suit NV7000  
 NV7200  
 Code VIA328



### PANASONIC SUPPLY REEL

Suit NV7000  
 NV7200  
 NV7800  
 etc...  
 Code VXR0103

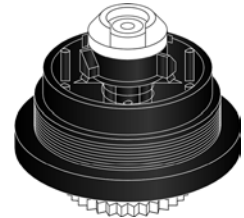

### PANASONIC SUPPLY GEAR

Suit NV100  
 Code VXP0402

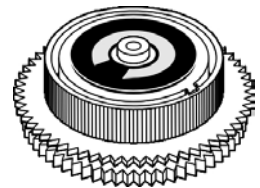

### PANASONIC IDLER PACK

Suit NV300 etc.  
 Code VXL0997

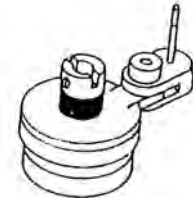

### REPLACEMENT

Code VIA381

### PANASONIC GEAR

Code VDG0235

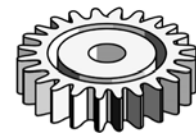

### PANASONIC DISC DRIVE

Code VDG0335

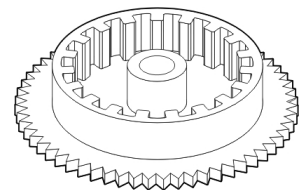

### PANASONIC INTERMEDIATE GEAR (B)

Suit NV370  
 Code VDG0115

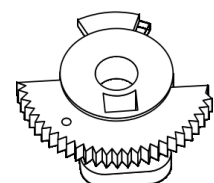



## PANASONIC PULLEY GEAR

Suit NV870  
Code VDG0142

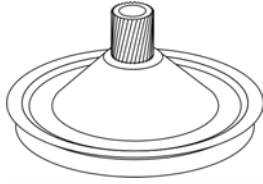

## PANASONIC DRIVE GEAR (2)

Suit NV850  
Code VDG0143

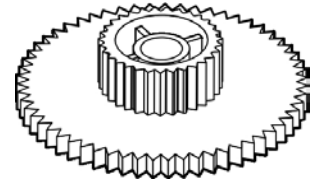

## PANASONIC IDLER ASSEMBLY

IDLER VXP0343

Suit NV7000  
NV7200  
Code VIA324

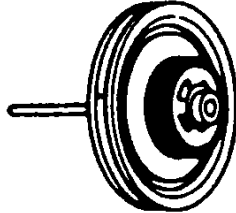

## PANASONIC GEAR

Suit NV370 etc.  
Code VDG0155

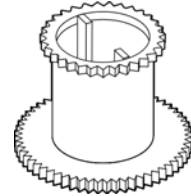

## PANASONIC TAKE-UP CLUTCH ASSEMBLY

Original VXLS0081  
Part No  
Code VIA385



## PANASONIC ROLLER POST

Suit NV730,  
NEC 911A  
Code VXP0444A



## PANASONIC TAKE-UP GEAR

Suit NV100  
Code VXP0403

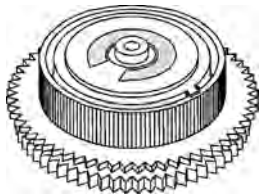

## PANASONIC TAKE-UP IDLER

Suit NV600  
Original VXP0488  
Part No  
Code VIA344

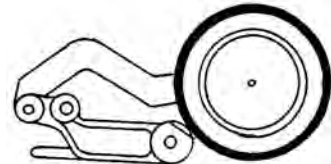

## PANASONIC TAKE-UP IDLER

Original VXP0433  
Part No  
Suit NV300 etc.  
Code VIA336

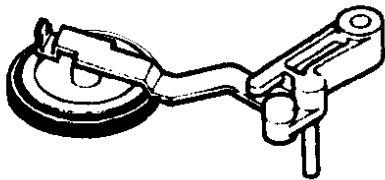

## PANASONIC KICK GEAR

Suit NV450,  
NVG10,  
NVG30  
Code VDG0178

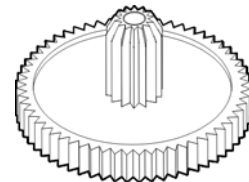

## PANASONIC CAM GEAR

Suit NV2000,  
NV3000,  
NV7000,  
NV7200  
Code VDG0035

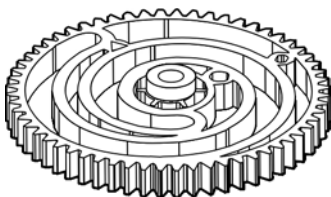

## PANASONIC INTERMEDIATE GEAR (A)

Suit NV450,  
NVG10,  
NVG30  
Code VDG0189

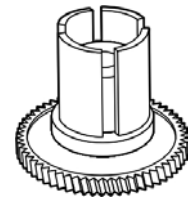

## PANASONIC SHAFT GEAR

Suit NV777  
Code VDG0119

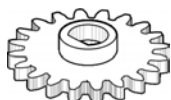

## PANASONIC PULLEY GEAR

Suit NVG30  
Code VDG0275

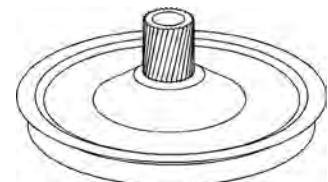





## PANASONIC WIPER ARM

Suit NVG7, 9,  
NVG10, 11,  
NVG12, 16.  
Code VML1756

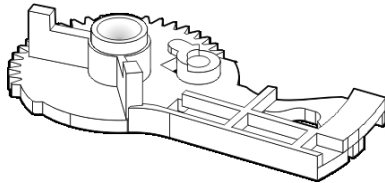

## PANASONIC DRIVE GEAR (B)

Suit NVG10  
Code VDG0278

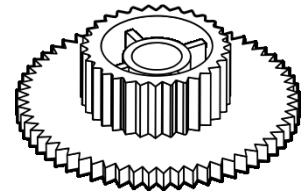

## PANASONIC INTERMEDIATE GEAR

Suit NV370,  
NV777, etc.  
Code VDG0146

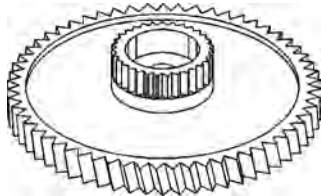

## PANASONIC SUPPLY REEL GEAR

Suit NVG20  
Code VDG0337

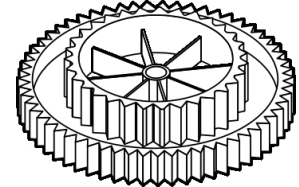

## PANASONIC GEAR

Suit NV370 etc.  
Code VDG0156

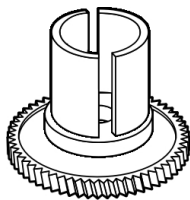

## PANASONIC SUB CAM GEAR

Suit NVF55, S1,  
NVJ35, etc.  
Code VDG0343

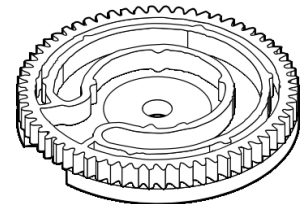

## PANASONIC GEAR

Suit NV370,  
NV777  
Code VDG0177

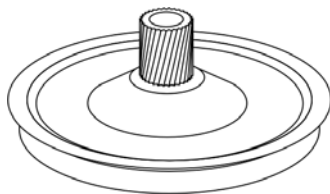

## PANASONIC MAIN CAM GEAR

Suit NVFS1,  
NVJ35, etc.  
Code VDG0346

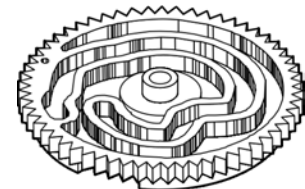

## PANASONIC IDLER

Suit NV777,  
NV788  
Original  
Part No VXP0463  
Code VIA340

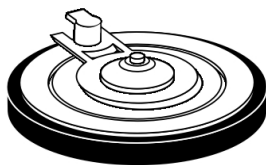

## PANASONIC CLUTCH DISC

Suit NVD48, FS1,  
NVH65,  
NVL25,  
RTV560, etc.  
Code VDG0349

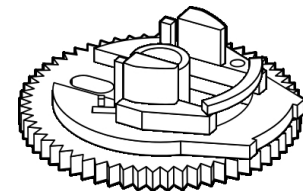

## PANASONIC INTERMEDIATE GEAR (B)

Suit NV450,  
NVG10,  
NVG30  
Code VDG0188

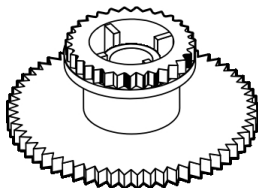

## PANASONIC P5 SECTOR PULL GEAR

Suit NVG20, 22, NVG20, 22,  
NVJ700 NVJ700  
Code VDG0651 VDG0357

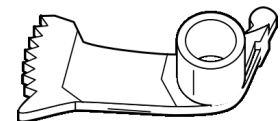

## PANASONIC CAM GEAR

Suit NV370, 450,  
NVG10, 30, etc.  
Code VDG0200

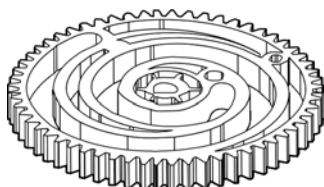

## PANASONIC PINCH CAM KIT

Suit NVD38,  
F55, FS1,  
NVG33,  
H65, J1,  
NVL20, W1,  
RTV740, etc.  
Code VDG0421

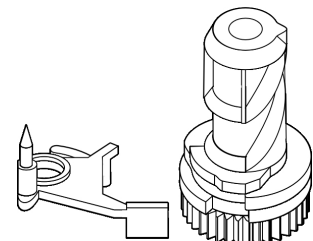



## PANASONIC GEAR

Suit	NVD38, F55,FS1, NVG33, H65,J1, NVL20,W1, RTV740,etc.	NVD38, F55,FS1, NVG33, H65,J1, NVL20,W1, RTV740,etc.
Code	VDG0483	VDG0334

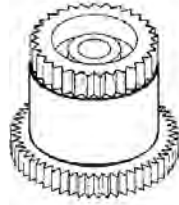

## PANASONIC RETAINER GEAR

Suit	NVD38, F55,FS1, NVG33, H65,J1, NVL20,W1, RTV560,etc.
Code	VDG0422

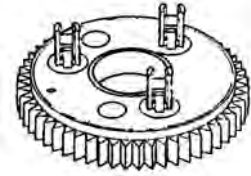

## PANASONIC CLUTCH DISC

Suit	NVD38, F55,FS1, NVG33, H65,J1, NVL20,W1, RTV740,etc.
Code	VDG0547

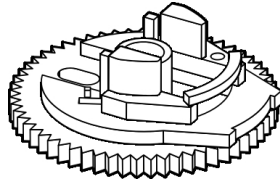

## PANASONIC LOADING CAM GEAR

Suit	NVD38, F55,FS1, NVG33, H65,J1, NVL20,W1, RTV560,etc.
Code	VDG0448

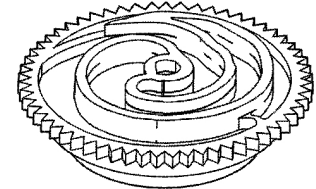

## PANASONIC RING GEAR

Suit	NVF55,FS1, NVJ35,etc.
Code	VDG0342

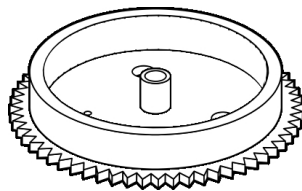

## PANASONIC MAIN CAM GEAR

Suit	NVD38, F55,FS1, NVG33, H65,J1, NVL20,W1, RTV560,etc.
Code	VDG0574

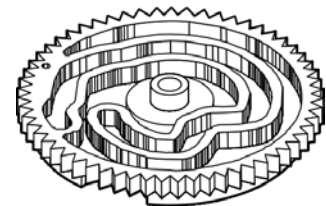

## PANASONIC PLANET GEAR

Suit	NVF55,FS1, NVJ35,etc.
Code	VDG0345



## PANASONIC GEAR

Suit	NVF55,FS1, NVJ45,etc.	NVF55,FS1, NVJ45,etc.
Code	VDG0332	VDG0664



## PANASONIC CENTRE GEAR

Suit	NVF55,FS1, NVJ35,etc.
Code	VDG0348

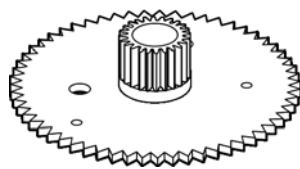

## PANASONIC GEAR KIT

Original Part No	VUA4100KIT
Suit	NVG mech' RTV560,etc.
Code	VUA4100

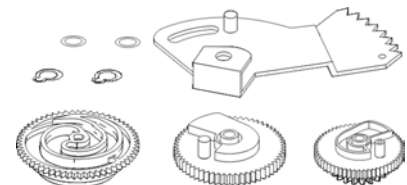

## PANASONIC CLUTCH DISC LEVER

Suit	NVD48,FS1, NVH65, NVL25, RTV740,etc.
Code	VDG0350

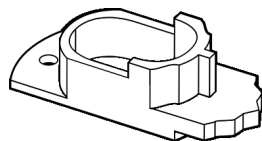

## PANASONIC SUB LOADING ARM

Suit	NVD38,FS1, NVG20,H75, NVL20,etc. RTV560,etc.
Code	VXL1480

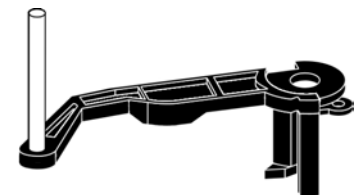

## PANASONIC LOADING GEAR (S)

Suit	NVD38, F55,FS1, NVG33,H65,J1, NVL20,W1, RTV560,etc.
Code	VDG0419

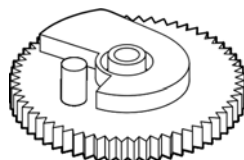

## PANASONIC TENSION ROLLER

Suit	NVF55,FS1,etc
Code	VXA3516

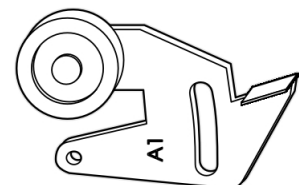



## PANASONIC ROLLER

Suit NVSD10, etc.  
Code VXA4799

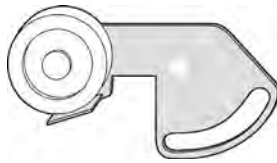

## PANASONIC RELEASE LEVER

Suit NVF55, FS1,  
NVG10, J45, etc.  
RTV560, etc.  
Code VML1860

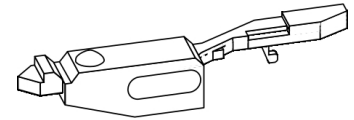

## PANASONIC CAPSTAN BEARING

Suit NVSD10, etc.  
Code VXD0140

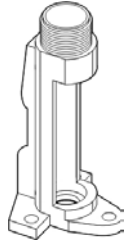

## PANASONIC SUB LOADING ARM

Suit NVF55, J1, NVF55, J1,  
NVL25, etc. NVL25, etc.  
Code VXL1856 VXL1857

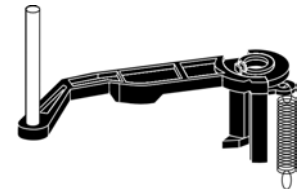

## PANASONIC CLUTCH GEAR

Original VXP0599  
Part No  
Suit NV250...  
NVG10 etc.  
Code VIA360

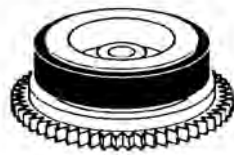

## PANASONIC POST UNIT

Suit NVF55, FS1, etc  
Code VXL1485

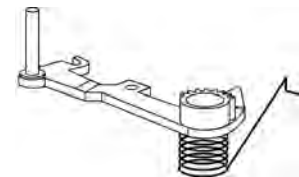

## PANASONIC GEAR

Suit NV370 NV850  
etc.  
Code VXP0523

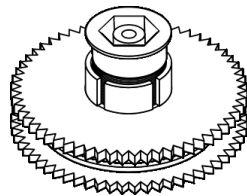

## PANASONIC CAPSTAN BRAKE

Suit NVG10, 20,  
NVG30, etc.  
Code VXZ0185

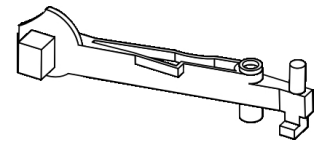

## PANASONIC CLUTCH GEAR IDLER

Suit NV370, NV370,  
780, 850 780, 850  
Code VXP0595 VDG0147



## PANASONIC IDLER ASSEMBLY

Original VXP0521  
Part No  
Suit NV250, 450, G10  
etc.  
Code VXP0521



## PANASONIC CENTRE CLUTCH

Suit NV280 NVG7,  
10, NVG12  
etc.  
Code VXP0600

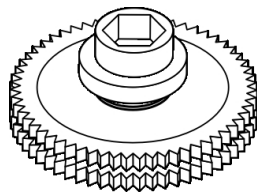

## PANASONIC IDLER

Original VXP0581  
Part No  
Suit NV730, 770.  
Code VIA350



## PANASONIC LOADING GEAR

Suit NV370,  
NV850, etc.  
Code VXP0520

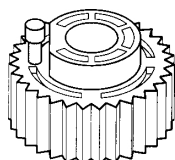

## PANASONIC WORM WHEEL PACK

Suit NV250, 280, 450, 470,  
730, 770, 870, etc.  
Code VXP0604

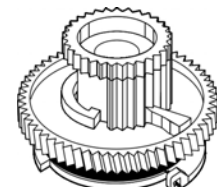



# Video Repair Parts

## PANASONIC CAM CAP

Code VMX1353

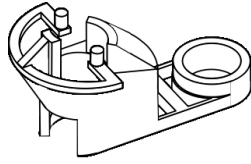

## PANASONIC SPACER

Code VMX0259

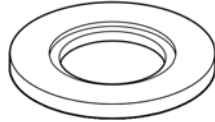

## PANASONIC GEAR PACK

Kit combines  
VDG0345 X3  
VDG0422 X1

Suit NVG mech'  
RTV560, etc.  
Code VXP0878

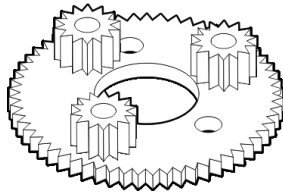

## PANASONIC "G" MECHANISM PARTS KIT

Contains VXL1490,  
VXL1743, VXP0878,  
VDG0597, VML1849,  
VMX1079, washers  
and C rings.

Code VUA4104

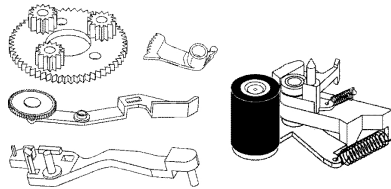

## PANASONIC PINCH CAM UNIT

Suit NVSD Mech.  
Code VDG0886

Suitable for the  
Pinch roller assembly  
VXL2246 (4-28)

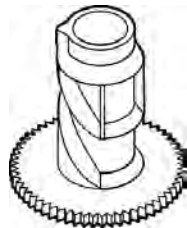

## PANASONIC MAIN LEVER UNIT

Suit NVSD Mech.  
Code VXL2307

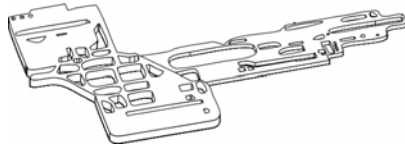

## PANASONIC IDLER ASSEMBLY

Suit NVSD10A  
NVSD20A  
NVSD30A  
Equiv. VXL2229  
Code VXL2378

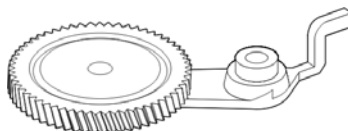

## PANASONIC ARM

Suit Super Drive  
Equiv. VXL2243  
Code VXL2394

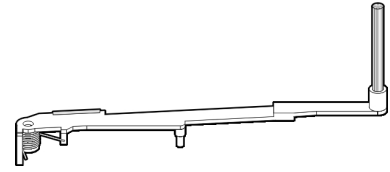

## PANASONIC GEAR

Suit NVSD10A  
NVSD20A  
NVSD30A  
Code VDG0868

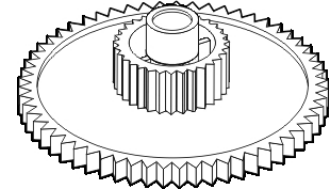

## PANASONIC AUTO HEAD CLEANER

Suit NVSD10, 20,  
NVSD400, etc.  
Code VXL2440

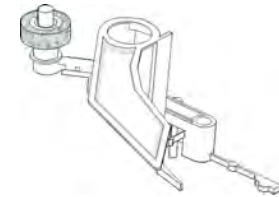

## PANASONIC AUTO HEAD CLEANER

Suit Super Mech.  
Code VXL2384

DISCONTINUED!  
Use VXL2440 above.

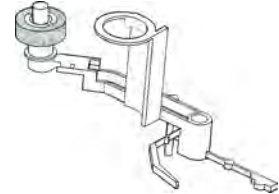

## PANASONIC CLEANER ROLLER

Suit NVHD620,670,  
NVSD220,230,  
NVSD270,280,  
NVSD420,430.  
Code VDP1668K



## PANASONIC SIDE PLATE

Includes opener  
lever VXL2250

Suit NVSD10A,  
NVSD20A,  
NVSD30A  
Code VXA4660

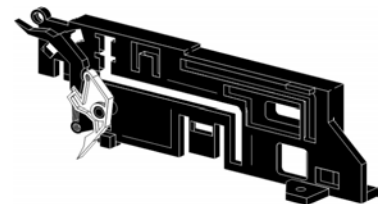

## PANASONIC SIDE PLATE

Suit NVSD10A,  
NVSD20A,  
NVSD30A  
Code VXA4806

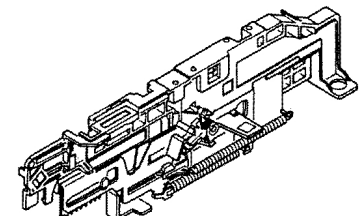





## PANASONIC CASSETTE HOLDER

Suit NVSD10, NVF65, 66,  
20, 30 70, 90  
Equiv. VXA3832  
Code VXA4661 VXA3840

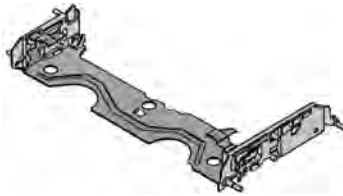

## PANASONIC BRAKE

Code VXZ0262

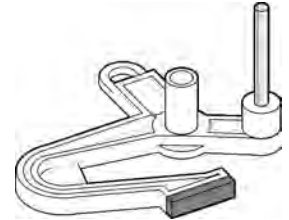

## PANASONIC SHAFT ASSEMBLY

Suit NVSD10A,  
NVSD20A,  
NVSD30A  
Code VXP1339

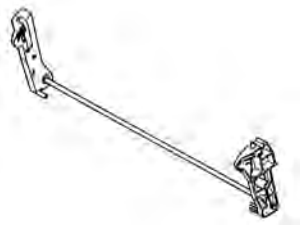

## PANASONIC BRAKE

Suit Super Drive  
Code VXZ0274

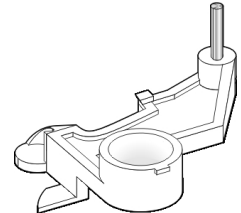

## PANASONIC SIDE PLATE

Suit NVL20, 25,  
'G' Mech  
Code VXA4076

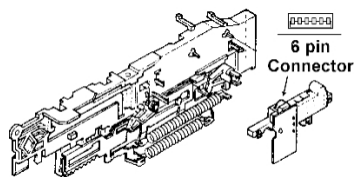

## PANASONIC SPRING

Code VMB1288

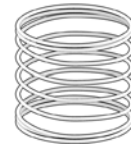

## PANASONIC SIDE PLATE

Suit NVG25, 28,  
'G' Mech  
Equiv. VMD918  
NVH65, 75,  
Code VXA3015

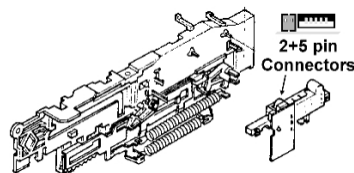

## PANASONIC BRAKE

Suit NVSD10A,  
NVSD20A,  
NVSD30A  
Code VXZ0313

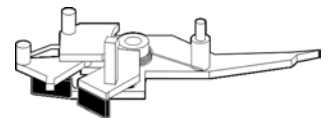

## PANASONIC SIDE PLATE

Original PCB#  
Part No VEP00R12  
Suit NVJ45, etc.  
Code VXA4468

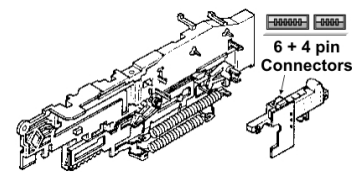

## PANASONIC BRAKE

Suit NVG Mech.  
Code VXL2088

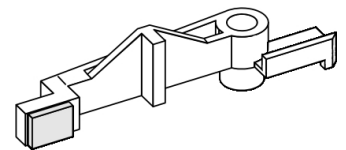

## PANASONIC SHAFT

Suit NVG33,  
NVH75, etc.  
Equiv. VXP0987  
Code VXP0851

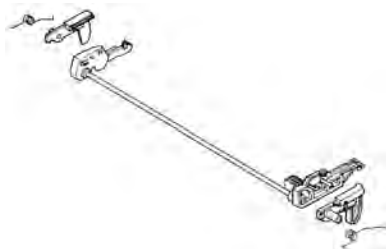

## PANASONIC BRAKE

Code VXL1500

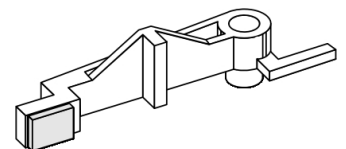

## PANASONIC BRAKE

Suit NVSD10  
Code VXZ0312

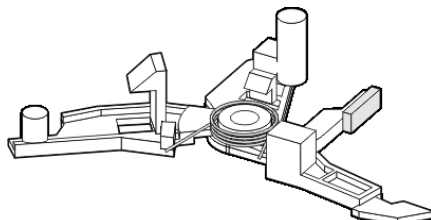

## PANASONIC GEAR

Code VDG0885

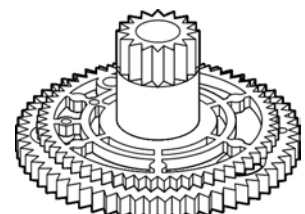



## PANASONIC LOADING ARM

Suit NVSD10A,  
NVSD20A,  
NVSD30A  
Code VXL2299

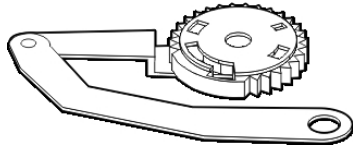

## PANASONIC GEAR KIT

Kit combines VXP0767  
VDV0159 and washers.

Code VXP0917K

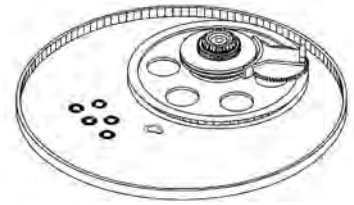

## PANASONIC LOADING ARM

Suit NVSD10A,  
NVSD20A,  
NVSD30A  
Code VXL2300

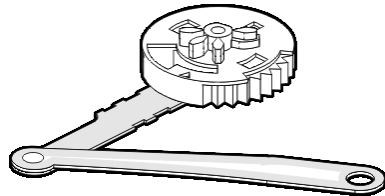

## PANASONIC CAM GEAR

Suit NVSD20A  
Code VDG0913

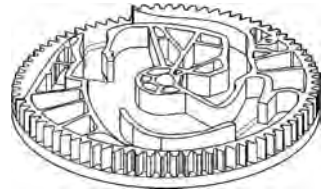

## PANASONIC SUBLOAD ARM

Code VXL2306

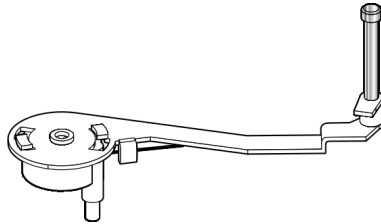

## PANASONIC ARM

Code VXL1244

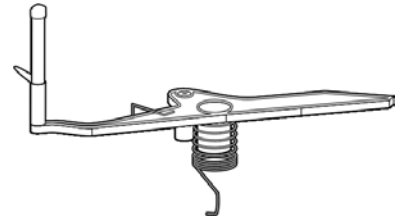

## PANASONIC GEAR

Suit NVSD10A,  
NVSD20A,  
NVSD30A  
Equiv. VDG0862  
Code VDG0957

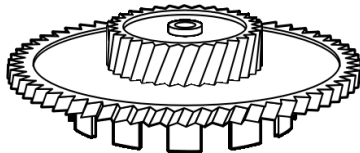

## PANASONIC GEAR

Suit NV2000, NV3000,  
NV7000, NV7200,  
NV7800  
Code VDG0017

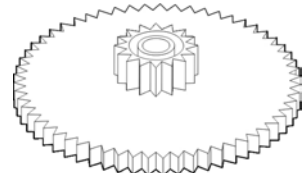

## PANASONIC GEAR

Suit NVSD10A,  
NVSD20A,  
NVSD30A  
Equiv. VDG0861  
Code VDG0956

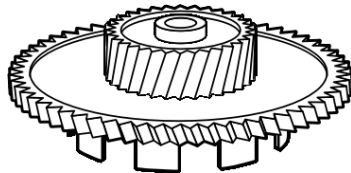

## PANASONIC CARRIAGE DOWN GEAR

Suit NVSD1, NVSD10,  
NVSD20  
Code VDG0871

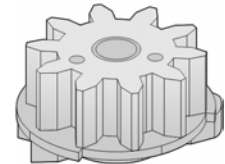

## PANASONIC CLUTCH

Suit NVSD10A,  
NVSD20A,  
NVSD30A  
Code VXP1409

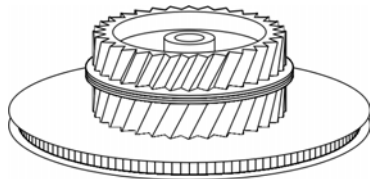

## PANASONIC WORM GEAR

As used with: VEM0427 Motor

Suit NVSD10, 20, etc.  
Code VDG0866



## PANASONIC ARM

Original Part No VXL1861,  
VXL1490  
Suit NV-J11 etc.,  
NV-G, etc.,  
RTV560, etc.  
Code VXL1861

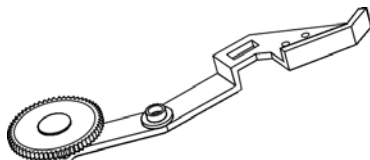

## PANASONIC PULLEY MOTOR COUPLING

As fitted to: VEM0427 Motor

Suit NVSD10, 20, etc.  
Code VDP1434

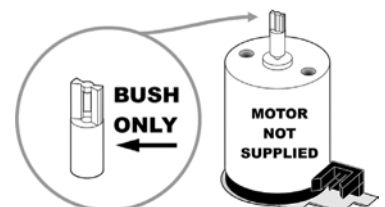



## PANASONIC MAIN CAM

Original Part No VDG1220

Suit NVSD220, 270, NVSD420, NVHD620, 670.

Code VDG1220



## PANASONIC IDLER ARM

Original Part No VXL2678, VXL2792

Suit NVSD220, 270, NVSD420, NVHD620, 670.

Code VXL2792

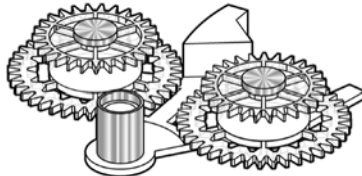

## PANASONIC CONVERSION GEAR

Suit NVSD220, 270, NVSD420, NVHD620, 670.

Original Part No VDG1221

Code VDG1221

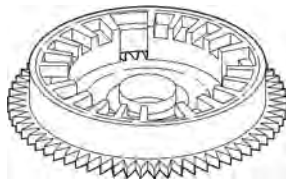

## PANASONIC CENTRE CLUTCH

Suit NVHD NVSD, NVSJ & NVFJ

Original Part No VXP1732

Code VXP2035

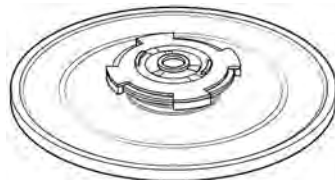

## PANASONIC CENTRE CLUTCH

Original Part No VXP1850

Suit NV-FJ600, NV-FJ720, NV-SJ720

Code VXP2053



## PANASONIC TAKE-UP BRAKE

Original Part No VXL2667, VEK8239

Suit NVSD220, 270, NVSD420, NVHD620, 670.

Code VXL2667

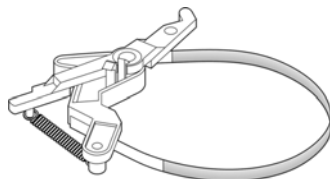

## PANASONIC LOADING ARM

Suit NVSD220, 270, NVSD420, NVHD620, 670.

Code VXL2670

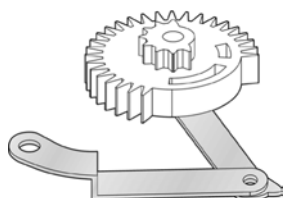

## PANASONIC LOADING ARM

Suit NVSD220, 270, NVSD420, NVHD620, 670.

Code VXL2672

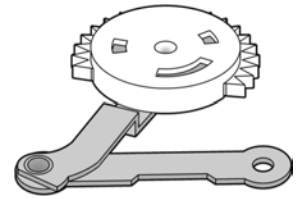

## PANASONIC REVIEW ARM UNIT

Suit NVHD100,600, NVHS950, NVSD10,20, TC20S, TC21L, TC51RM52, SM52, VR743/75, AG526,

Code VXL2310

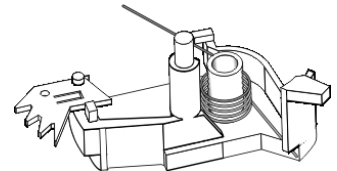

## PANASONIC INCLINED BASE [T]

Suit NV-SJ200A, NV-SJ400A, NV-FJ600A, NV-FJ720A

Code VXA5854



## PANASONIC MAIN LEVER

Suit NV-SJ200A, NV-SJ400A, NV-FJ600A, NV-FJ720A

Code VML3166



## Samsung

### SAMSUNG

AKAI  
PALSONIC  
FUNAI  
GOLDSTAR  
TEAC



### SAMSUNG/AKAI IDLER

Original Part No 9000 250 3308, 6900 025 0330

Suit VS200 etc. and equiv.

Code VIA40

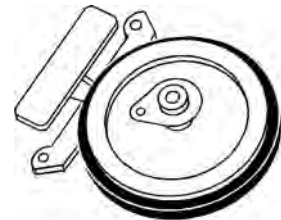

### SAMSUNG IDLER

Code VIA700

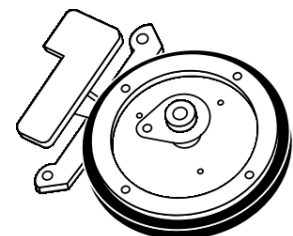



## SAMSUNG/TEMPEST IDLER

Original 5253-701-1105  
 Part No 65253-701-110  
 Suit TE900, VB900,  
 VB910, VB2215  
 Code VIA710

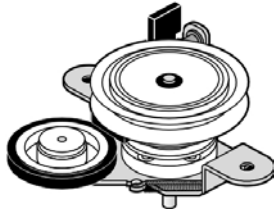

## SAMSUNG/TEMPEST IDLER

Original 66052-600-310  
 Part No  
 Suit TE77R, VRD100,  
 VCP90R, VB711, 750,  
 VB8220, PB980, 981,  
 Code VIA730

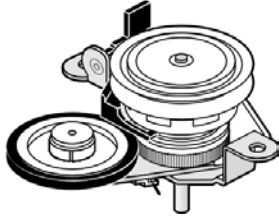

## SAMSUNG/AKAI/TEMPEST IDLER

Original 65153-600-011  
 Part No 65153-600-100  
 Suit TE90H, VS11,12,  
 DS757  
 Code VIA720

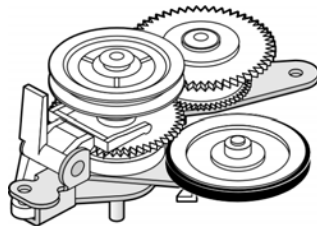

## SAMSUNG TEMPEST REEL BRAKE

Original 47647007205  
 Part No  
 Suit VB520, 900,  
 Akai VS200,  
 TE900H  
 Code RDB900



## SAMSUNG LOADING SHAFT

Original 61043002500  
 Part No  
 Suit VB300 VB370, etc.  
 Code CH2500



## SAMSUNG PINCH DRIVE

Supplied locked into alignment.

Original 67179-0069-01  
 Part No  
 Suit VB300, etc.  
 Code GR6901

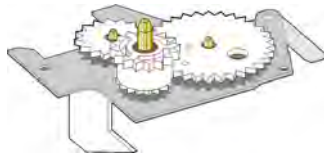

## SAMSUNG GEAR RELAY S1

Original 61474006101  
 Part No  
 Suit VB300 VB370, etc.  
 Code GR6101

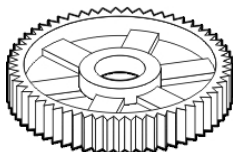

## SAMSUNG GEAR RELAY S2

Original 61474006201  
 Part No  
 Suit VB300 VB370, etc.  
 Code GR6201

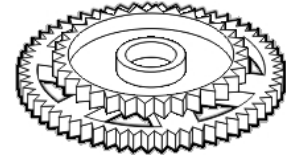

## SAMSUNG GEAR RELAY T

Original 61474006001  
 Part No  
 Suit VB300 VB370, etc.  
 Code GR6001

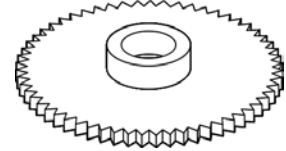

## SAMSUNG GEAR RELAY S3

Original 61474006301  
 Part No  
 Suit VB300 VB370, etc.  
 Code GR6301

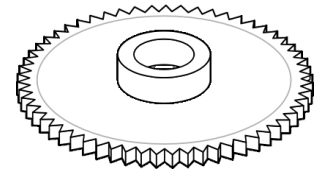

## SAMSUNG IDLER SUB ASSEMBLY

Original 61604000301  
 Part No  
 Suit VB300 VB370, etc.  
 Code GR3001

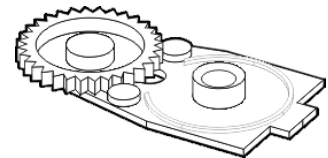

## SAMSUNG GEAR ESCALATOR

Original 61472005401  
 Part No  
 Suit VB300 VB370, etc.  
 Code GR5401

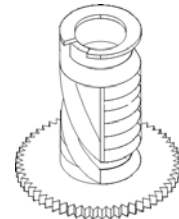

## SAMSUNG GEAR WORM WHEEL

Original 61473005302  
 Part No  
 Suit VB300 VB370, etc.  
 Code GR5302

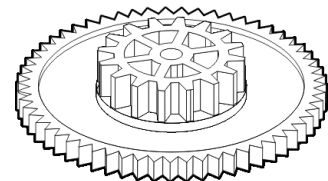

## SAMSUNG GEAR MASTER

Original 61472005502  
 Part No  
 Suit VB300 VB370, etc.  
 Code GR5502

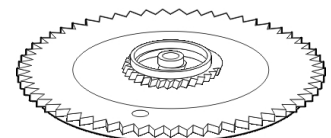





## SAMSUNG LOADING MOTOR

Includes Gears, Motor, etc.

Original 67179-0068-00  
Part No  
Code MEC6800

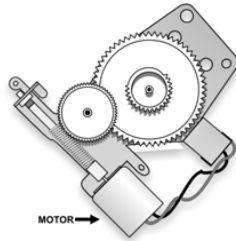

## SAMSUNG GEAR CLUTCH

Original 66053-604-420  
Part No  
Suit VB1560  
Code GIA4420

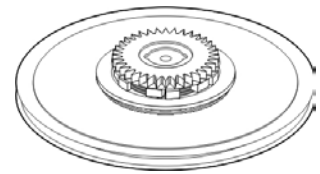

## SAMSUNG GEAR EJECT

Original 61473005101  
Part No  
Suit VB300 VB370, etc.  
Code GR5101

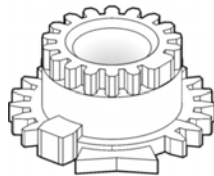

## SAMSUNG LOAD GEAR R

Original 6526 460 6610  
Part No  
Suit PB990, VB1230,  
VB1260, 1530, 1850.  
Code GR6610



## SAMSUNG GEAR IDLER ASSEMBLY

Original 61453000101  
Part No  
Suit VB300 VB370, etc.  
Code GIA1001

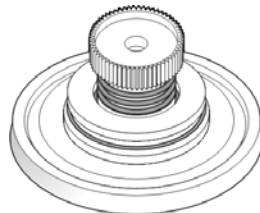

## SAMSUNG GEAR JOINT

Original 6520 360 5330  
Part No  
Suit PB990, VB1230,  
VB1260, 1530, 1850.  
Code GR5330



## SAMSUNG LOAD SLIDE LEVER

Original 66602603510  
Part No  
Suit VB300 VB370, etc.  
Code LEV3510

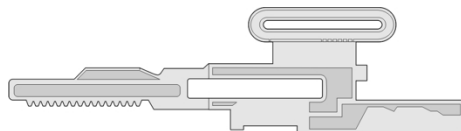

## SAMSUNG IDLER ASSEMBLY

Original 61603-0006-00  
Part No  
Suit SV10, 11, 12, SV30,  
80, 140  
Code GIA600

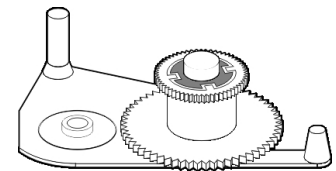

## SAMSUNG GEAR LOAD LEFT

Suit VB300 VB370, etc.  
Original 61473004701  
Part No  
Code GR4701

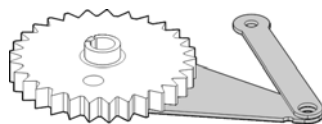

## SAMSUNG CLUTCH ASSEMBLY

Original 61453-0003-00  
Part No  
Suit SV10, 11, 12, SV30,  
80, 140  
Code VIA300

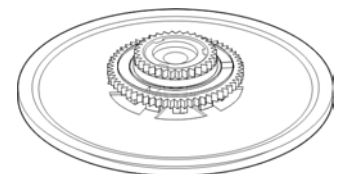

## SAMSUNG GEAR LOAD RIGHT

Suit VB300 VB370, etc.  
Original 61473004501  
Part No  
Code GR4501

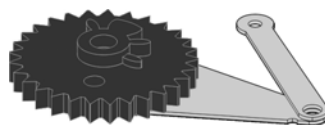

## SAMSUNG LOADING GEAR (L)

Original 61473-0107-00  
Part No  
Suit SV10, 11, 12, SV30,  
80, 140  
Code GR1070

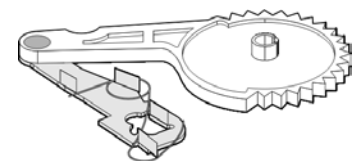

## SAMSUNG IDLER SUB-ASSEMBLY

Original 66054-609-411  
Part No  
Code GIA9411

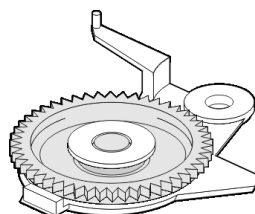

## SAMSUNG LOADING GEAR (R)

Original 61473-0105-00  
Part No  
Suit SV10, 11, 12, SV30,  
80, 140  
Code GR1050

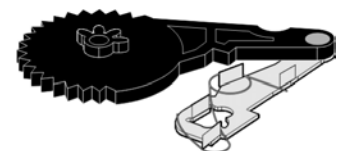



## SAMSUNG MASTER CAM GEAR

Original 61472010011  
 Part No 614720104011G11  
 Suit SV10, 11, 12,  
 SV30, 80, 140  
 Code MCG1001

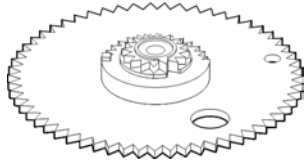

## SAMSUNG WORM WHEEL

Original 61473-0102-00  
 Part No  
 Suit SV10, 11, 12,  
 SV30, 80, 140  
 Code GR1020

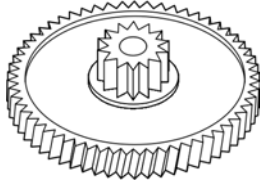

## SAMSUNG SHAFT ARM (F/L)

Original 61403-0073-00  
 Part No  
 Suit SV10, 11, 12,  
 SV30, 80, 140  
 Code ARM73

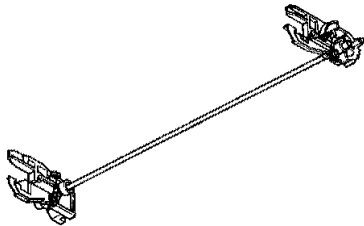

## SAMSUNG F/L ARM

Original AC66-30546A  
 Part No  
 Suit SV220B SV435B  
 Code LEV0546



## SAMSUNG GEAR

Original AC66-00039A  
 Part No  
 Suit SV220B SV435B  
 Code GR0039



## SAMSUNG CAM ARM

Original AC66-30013A  
 Part No  
 Suit SVA130B  
 Code ARM0013



## SAMSUNG DVD-VCR CENTRE GEAR

DVD-VCR Combo' unit.

Original AC66-20581A  
 Part No  
 Suit DVD-V5000 DVD-V7500  
 SV235, 240, SV245, etc.  
 Code GRC2058

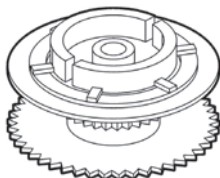

## Sanyo / Fisher / Sony



# SANYO

## SANYO/FISHER IDLER ASSEMBLY

Original 143-0-741T-20001  
 Part No  
 Code VIA512



## SANYO IDLER ASSEMBLY

Original 143-0-6627-01202  
 Part No or 613-037-4677  
 Suit VCT5000  
 Code VIA514

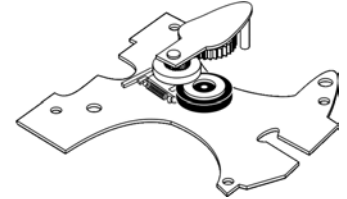

## SANYO IDLER ASSEMBLY

Original 613-037-4776  
 Part No  
 Suit M10, M20  
 Code VIA513

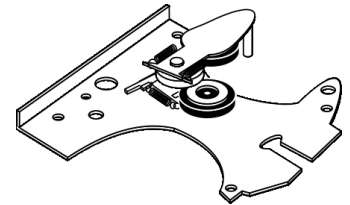

## SANYO/FISHER IDLER

Original 143-0-551T-01600  
 Part No  
 Code VIA504

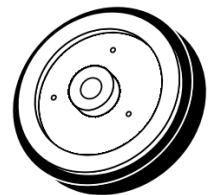

## SANYO IDLER ASSEMBLY

Original 621-009-9971,  
 143-0-4204-00300,  
 143-0-4204-00400  
 Part No  
 Suit FVHP710, 720,725  
 Code VIA540

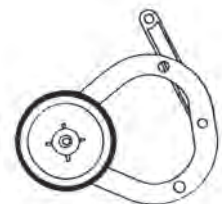

## SANYO IDLER ASSEMBLY

Original 143-0-4204-00100  
 Part No  
 Code VIA560

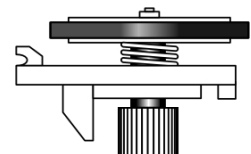



## SANYO/FISHER IDLER

Original 143-0-661T-03800  
 Part No  
 Code VIA508

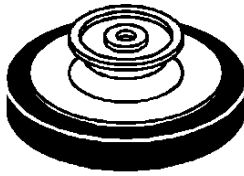

## SANYO ROLLER WIND PULLEY

Original 143-0-4804-00100  
 Part No Fisher FVH-P530  
 Code RWA530

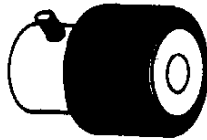

## SANYO IDLER ASSEMBLY

Original 143-0-662T-1560 or  
 Part No 613-037-4899  
 Suit VHR2700 etc.  
 Code VIA520

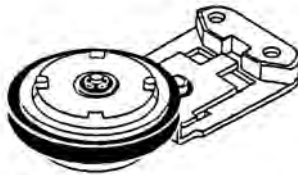

## SANYO IDLER ASSEMBLY

Original 143-0-581T-14001 or  
 Part No 613-037-3410  
 Suit VHR3500 etc.  
 Code VIA530



## SANYO IDLER ASSEMBLY

Original 143-0-4904-00900 or  
 Part No 621-010-1612  
 Code VIA550

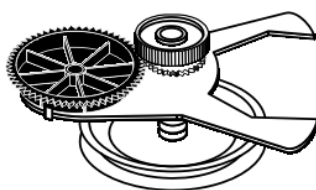

## SANYO IDLER ASSEMBLY

Original 613 037 4875  
 Part No  
 Suit VHR1100, 1300,1500  
 Code VIA565

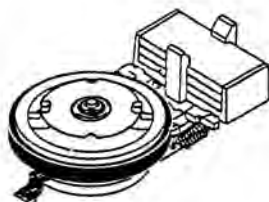

## SANYO ROLLER ASSEMBLY

Original 613-037-4905 or  
 Part No 143-0-662T-15621  
 Suit VHR3100, D500,etc  
 Code VIA570

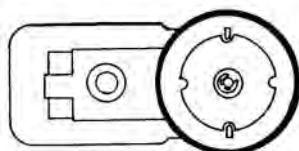

## SANYO/SONY GEAR

Original 613-0222-701  
 Part No  
 Suit VHR4100 SLVX10,20  
 Code GR2701

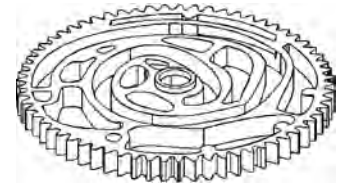

## SANYO/SONY IDLER ASSEMBLY

Original 613-022-0134 Also  
 Part No 613-093-3928  
 Suit VHR4100 SLVX10,20  
 Code GIA134



## SANYO IDLER CLUTCH

Original 613-085-7101  
 Part No  
 Equiv. 613-022-0141  
 Suit VHR5700, 6700 etc.  
 Code VIA568

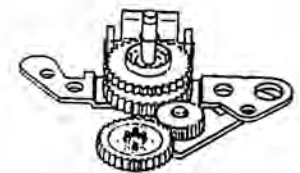

## SANYO IDLER CLUTCH

Original 613-100-4696  
 Part No  
 Suit SRT500P TLS900P  
 TLS924P TLS2000  
 TLSS2500P  
 Code VIA4696

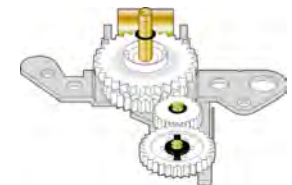

## SANYO CAM GEAR

Original 613-022-2718  
 Part No  
 Suit VHR4100  
 Code GR2718

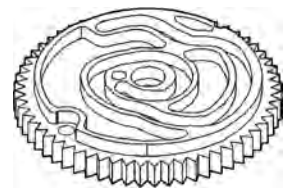

## SANYO FRICTION GEAR

Original 613-022-0066  
 Part No 613-102-0900  
 Suit VHR4100,  
 VHR5700,  
 SVX10, 20,  
 etc & Sony  
 Code GR2266

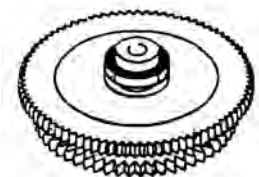

## SANYO GEAR

Original 143-0-581T-13800  
 Part No  
 Suit VHR3100 etc.  
 SV-VX10AS  
 Code GR3800





## SANYO CAM-SLIDE

This new upgrade part may differ from your part. Includes instructions.

Original Part No	6130949240
Suit	VHR190 VHRD4800
Code	CSA9240

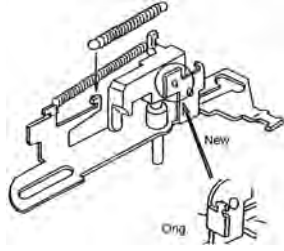

## SANYO GEAR (1)

Original Part No	613-151-9138
Suit	VHR510, 530, VHR590, 610, VHR630, 650
Code	GR9138

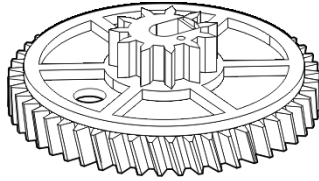

## SANYO CLEANING ROLLER

Original Part No	613-158-5829
Suit	VHR510, 530, VHR590, 610, VHR630, 650
Code	RL5829



## SANYO GEAR REEL

Original Part No	613-152-2756
Suit	VHR510, 530, VHR590, 610, VHR630, 650
Code	GR2756

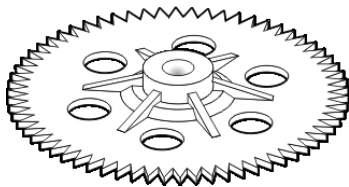

## SANYO GEAR

Original Part No	613-152-2770
Suit	VHR510,530, VHR590,610, VHR630, 650.
Code	GR2770

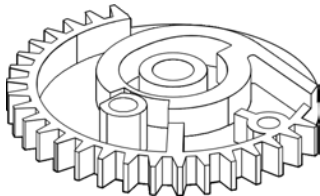

## SANYO GEAR

Original Part No	613-152-2763
Suit	VHR510,530, VHR590,610, VHR630,650.
Code	GR2763

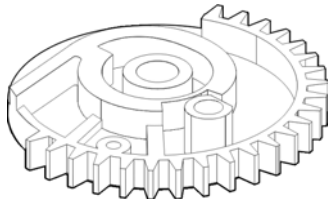

## SANYO PULLEY WHEEL

Original Part No	613-151-9701
Suit	VHR510,530, VHR590,610, VHR630,650.
Code	GR9701

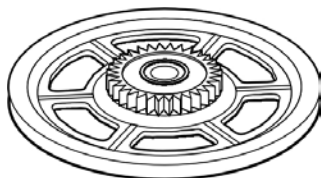

## SANYO GEAR

Original Part No	613-156-3841
Suit	VHR510,530, VHR590,610, VHR630,650.
Code	GR3841

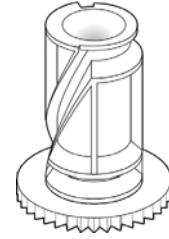

## SANYO GEAR CLUTCH

Original Part No	613-160-4186
Suit	VHR510, 530, VHR590, 610, VHR630, 650
Code	GR4186

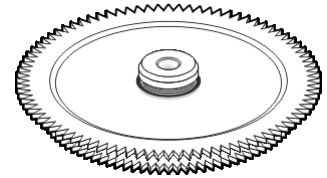

## SANYO CAM GEAR

Original Part No	613-156-4008
Suit	VHR510, 530, VHR590, 610, VHR630, 650
Code	GR4008

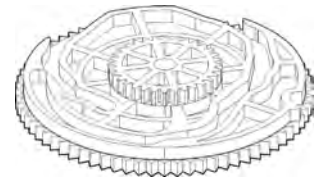

## Sharp

### SHARP IDLER ASSEMBLY

Original Part No	NIDL0005GEZZ
Code	NIDL0005

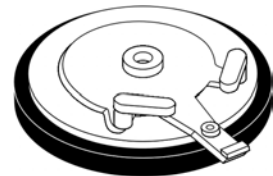

### REPLACEMENT

Code	VIA608
------	--------

### SHARP IDLER ASSEMBLY

Original Part No	NIDR0004GEZZ
Code	VIA616

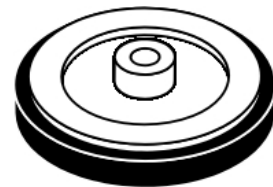

### SHARP IDLER ASSEMBLY

Original Part No	NPLYV0107GEZZ
Code	VIA632

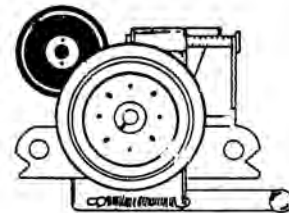

### SHARP IDLER ASSEMBLY

Original Part No	NPLYV0111GEZZ
Code	VIA636

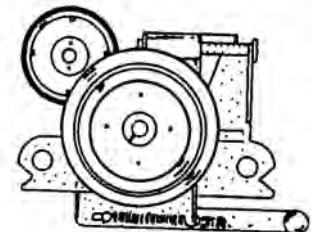





## SHARP MASTER CAM GEAR

Original Part No NGERH1024GEZZ  
 Suit 300 series, etc., Philips 4802 522 37129  
 Code MCG1024

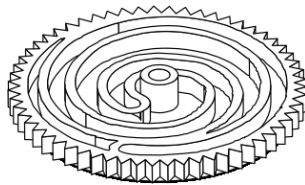

## SHARP GEAR IDLER ASSEMBLY

Without tape lock disable.

Original Part No NGERH1128GEZZ  
 Suit VCA115X, etc.  
 Code GIA1128

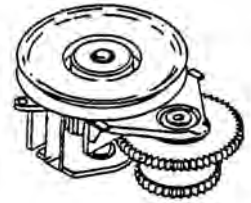

## SHARP IDLER ASSEMBLY

Original Part No NIDL0006GEZZ  
 Code NIDL0006

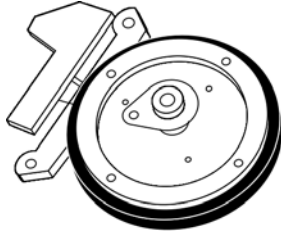

## SHARP WORM WHEEL

Original Part No NGERW1032GEZZ  
 Suit VCA505X etc.  
 Code GR1032

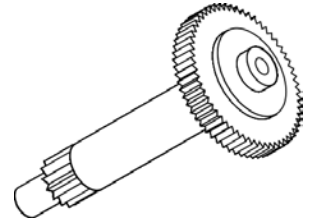

## SHARP IDLER

Original Part No NPLYV0051GEZZ,  
 Philips 4802 528 77224  
 Code VIA628

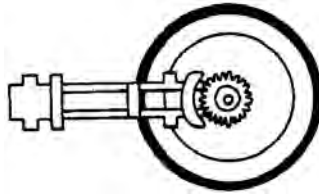

## SHARP MASTER CAM GEAR

Original Part No NGERH1074GEZZ  
 Suit VC600 series.  
 Code MCG1074

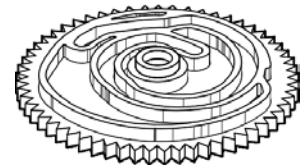

## SHARP MOTOR PULLEY

Original Part No NPLYV0121GEZZ  
 Suit MOTORS, RMOTV1004GEZZ, RMOTV1007GEZZ, RMOTV1008GEZZ, RMOTV1010GEZZ  
 Code MP121

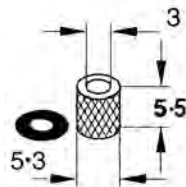

(See Motors this section)

## SHARP LEVER

Original Part No MLEV0135GEZZ  
 Suit VCF18  
 Code LEV0135

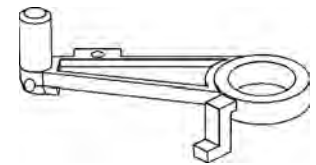

## SHARP MASTER CAM GEAR

Original Part No NGERH1043GEZZ  
 Suit VC400 series etc.  
 Code MCG1043

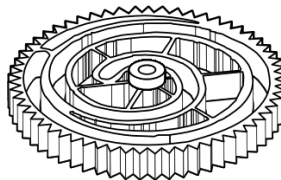

## SHARP LOADING GEAR

Original Part No NGERH1022GEZ  
 Suit VC481 etc.  
 Code GR1022

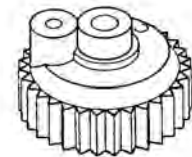

## SHARP LEVER

Original Part No MLEV0134GEZZ  
 Suit VCF18, VCA105X  
 Code LEV0134

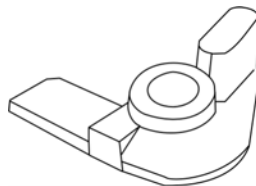

## SHARP LOADING GEAR

Original Part No NGERH1076GEZZ  
 Suit VCH851  
 Code GR1076

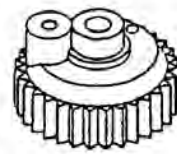

## SHARP GEAR IDLER ASSEMBLY

With tape lock disable.

Original Part No NGERH1122GEZZ  
 Suit VCA105, 111X, etc.  
 Code GIA1122

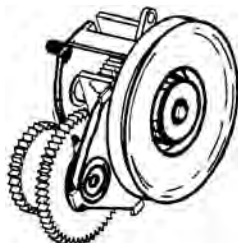

## SHARP LOADING GEAR

Original Part No NGERH3010GEZZ  
 Suit VC481 etc.  
 Code GR3010

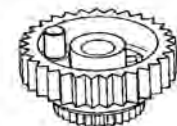



## SHARP CAM GEAR

Original Part No NGERH1073GEZZ  
 Suit VC600,700, 6F3, 6V3, etc.  
 Code GR1073

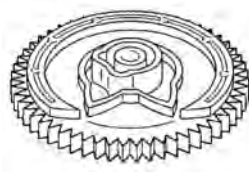

## SHARP LOADING GEAR

Original Part No NGERH1119GEZZ  
 Suit VCA111X  
 Code GR1119

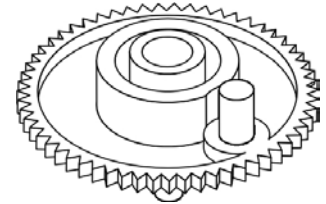

## SHARP CASSETTE LOAD ARM

Original Part No MARMP0029GEZZ  
 Suit VC651, 684, VC685, 686.  
 Code ARM29

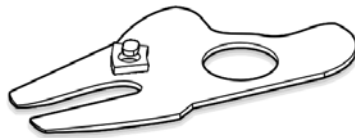

## SHARP BRAKE LEVER

Original Part No MLEVP0101GEZZ  
 Suit VCA101, 103, VCD801, etc.  
 Code LEV0101

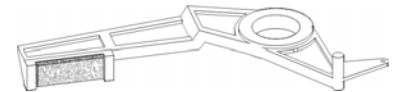

## SHARP CASSETTE UNLOCK KEY

Original Part No MARMP0026GEZZ  
 Suit VC9300  
 Code ARM26

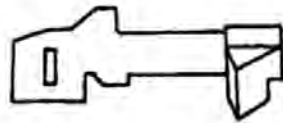

## SHARP TAPE GUIDE LEVER P5

Original Part No MLEVP0273AJZZ  
 Suit VCA200, 400, VCA600, 650.  
 Code LEV0273



## SHARP SPRING

Original Part No MSPRT0140GEFJ  
 Suit VC481 and other models.  
 Code SPR140



## SHARP CAM GEAR

Original Part No NGERH1268GE00  
 Suit VCA200, 250, VCA400, 450, VCA600, 650.  
 Code GR1268



## SHARP SPRING

Original Part No MSPRD0092GEFJ  
 Suit VC111X and other models.  
 Code SPR92

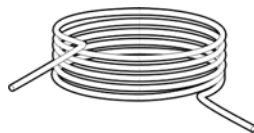

## SHARP LOADING GEAR

Original Part No NGERH1120GEZZ  
 Suit VCA,VCB, VCD,VCH, Series  
 Code GR1120

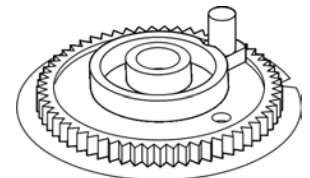

## SHARP SPRING

This fits LANG9

Original Part No MSPRD0021GEFJ  
 Code SPR21

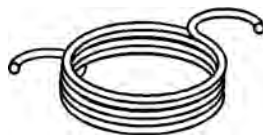

## SHARP CAM GEAR

many VC-A & VC-H Series.

Original Part No NGERH1129GEZZ  
 Code GR1129



## SHARP DOUBLE ACTION PLATE

Known as FIXING METAL.

Original Part No LANGJ0009GEZZ  
 Code LANG9

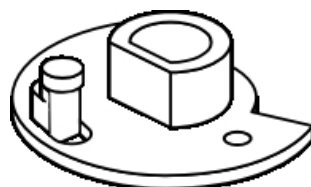

## SHARP CASSETTE LOAD ARMS

Description	Left NGERW1035GEZZ	Right NGERW1034GEZZ
Suit	VCF18,111, etc.	
Code	GR1035	GR1034

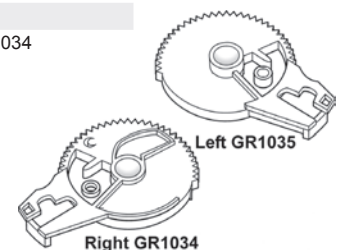



## SHARP CASSETTE OPENER

Original MLEVP0142GE00  
 Part No  
 Suit VCA111X etc.  
 Code LEV0142

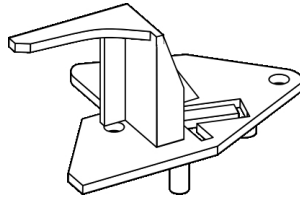

## SHARP MECHANISM

Original CCHSS0018GE02  
 Part No  
 Suit VCA35X etc.  
 Code CH0018

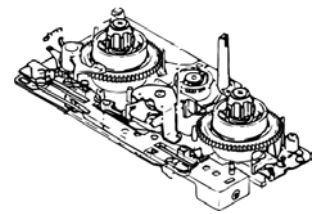

## SHARP CAM GEAR

Original NGERH1109GEZZ  
 Part No  
 Suit VCA201  
 Code GR1109

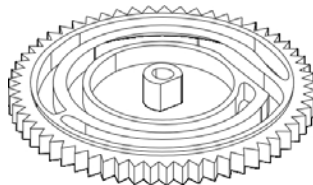

## SHARP ARM

Original MARMP0032GEZZ  
 Part No  
 Suit 600 series.  
 Code ARM32

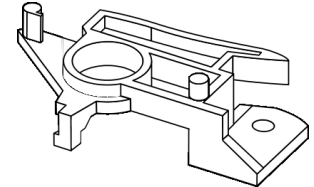

## SHARP CAM GEAR

Original NGERH1118GEZZ  
 Part No  
 Suit VCA & VCH series  
 Philips VCR's  
 VR6448, 6548 etc.  
 Code GR1118

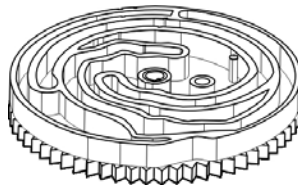

## SHARP LEVER

Original MLEVP0195GEZZ  
 Part No MLEVP0133GEZZ  
 Suit VCA101, 103, 111,  
 VCD805, VCH80X,  
 etc.  
 Code LEV0195

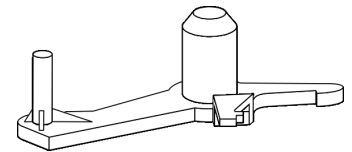

## SHARP CAM GEAR

Original NGERH1108GEZZ  
 Part No  
 Suit VCA series Philips  
 VCR's VR6448, 6548  
 etc.  
 Code GR1108

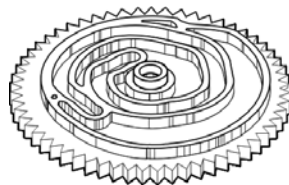

## SHARP LOADING ARM

Original MLEVF0420GEZZ  
 Part No  
 Suit VCA35X, 36X  
 VCA50X, etc.  
 Code LEV0420

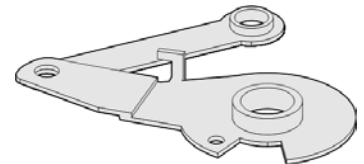

## SHARP TAKE-UP LOADING GEAR

Suit VCA36, 41, 62,  
 VCA72, 93, 97, &  
 More...  
 Code GR1219

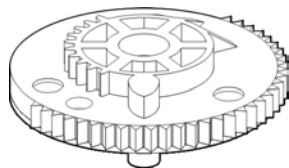

## SHARP LOADING ARM

Original MLEVF0422GEZZ  
 Part No  
 Suit VCA35X, 36X  
 VCA50X, etc.  
 Code LEV0422

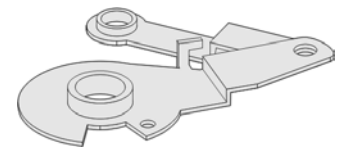

## SHARP MID DRIVE MASTER CAM

Original NGERH1217GEOO  
 Part No  
 Suit VCA36X, VCA50X  
 and others.  
 Code MCG1217

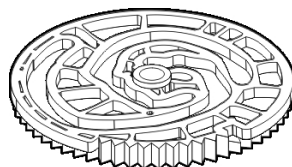

## SHARP WORM WHEEL

From cassette housing Right

Original NGERW1033GEZZ  
 Part No  
 Suit VCA111 VCF18  
 Code GR1033

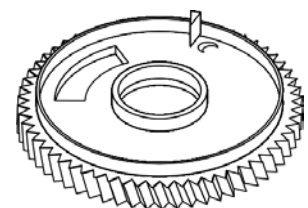

## SHARP MID DRIVE MASTER CAM

Original NGERH1218GEOO  
 Part No  
 Suit VCA36X VCA50X  
 and others.  
 Code GR2180

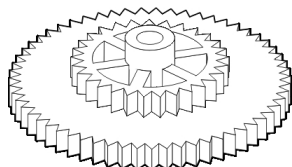

## SHARP LOADING GEAR

Original NGERH1121GEZZ  
 Part No  
 Code GR1121

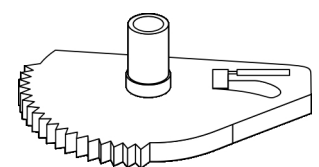



## SHARP CLUTCH MID-DRIVE

Original Part No NGERH1221AJZZ  
 Suit VCA36X, VCA50X and others.  
 Code GR1221

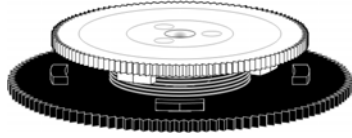

## SHARP REEL PULLEY MID-DRIVE

Original Part No NPLYV0147AJZZ  
 Suit VCA36X, VCA50X, and others.  
 Code VIA1470

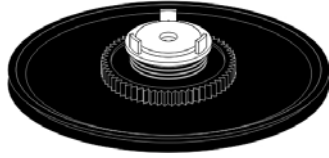

## SHARP PLAYBACK GEAR

Original Part No NGERH1224AJZZ  
 Suit VCA36X, VCA50X, and others.  
 Code GR1224

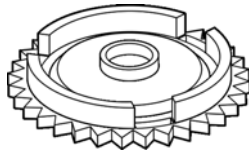

## SHARP CASS HOUSE MID-DRIVE

Original Part No NGERH1225GEZZ  
 Suit VCA36X, VCA50X, and others.  
 Code GR1225



## SHARP SLIDER HOLDER RIGHT

Original Part No LHLDX1010GEOO, LHLDX1012GEOO  
 Suit VCA111, VCF18  
 Code LDX1010

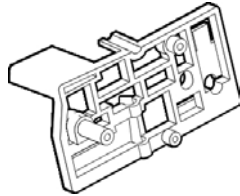

## SHARP SLIDER HOLDER LEFT

Original Part No LHLDX1011GEZZ  
 Equiv. LHLDX1013GEZZ  
 Suit VCF18, VCA111  
 Code LDX1011

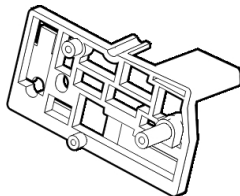

## SHARP SLIDE PLATE

Original Part No MSLIF0043GEZZ  
 Suit VCA111X  
 Code PS0043



## SHARP FRAME (R) MID-DRIVE

Original Part No LHLDX1025GEOO  
 Suit VCA36X, VCA50X, and others.  
 Code LDX1025

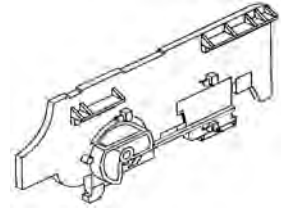

## SHARP FRAME (L) MID-DRIVE

Original Part No LHLDX1024GEOO  
 Suit VCA36X, VCA50X, and others.  
 Code LDX1024

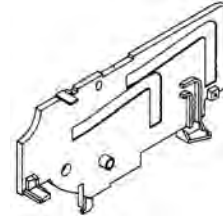

## SHARP SLIDER MID-DRIVE

Original Part No LHLDX1026GEOO  
 Suit VCA36X, VCA50X, and others.  
 Code LDX1026

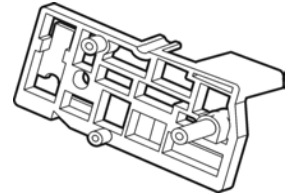

## SHARP GEAR MID-DRIVE

Original Part No NGERH1226GEOO  
 Suit VCA36X, VCA50X, and others.  
 Code GR1226

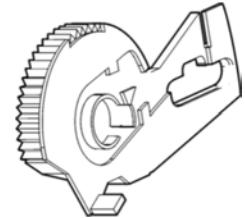

## SHARP CLEANING ROLLER

Original Part No CLEVP0239GEOO, CLEVP0239AJOO  
 Suit VCA36X, VCA50X, and others.  
 Code LEV0239

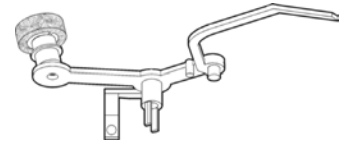

## SHARP MID-DRIVE

Original Part No NGERH1227GEZZ  
 Suit VCA36X, VCA50X, and others.  
 Code GR1227

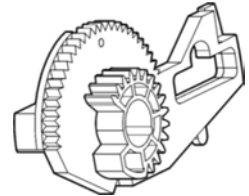

## SHARP LOAD GEAR - SUPPLY

Original Part No NGERH1220AJZZ  
 Suit VCA36, 37, 41, 50, 53, VCA53, 62, 63, 67, 72, VCH93, 94, 97, 98, VCMH83, 93, VT3428, 5128  
 Code GR1220

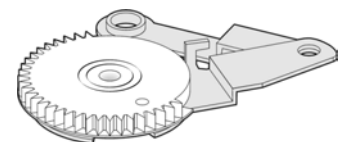





## SHARP OPEN LEVER

**Original Part No** MLEVP0238AJZZ

**Suit** VCA36, 37, 41, 50, 53, VCA53, 62, 63, 67, 72, VCH93, 94, 97, 98, VCMH83, 93, VT3428, 5128

**Code** LEV0238

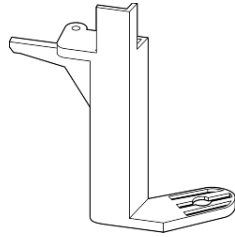

## SHARP SHIFTER

**Original Part No** MSLIP0006AJZZ

**Suit** VCA36,37,41,50,53,VCA53,62,63,67,72,VCH93,94,97,98,VCMH83,93,VT3428,5128

**Code** MSLIP0006

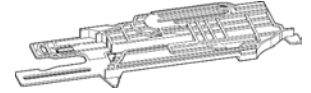

## SHARP CLUTCH LEVER

**Original Part No** MLEVP0240AJZZ

**Suit** VCA36,37,41,50,53,VC A53,62,63,67,72,VCH93,94,97,98,VCMH83,93,VT3428,5128

**Code** LEV0240

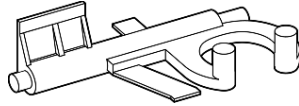

## SHARP CLUTCH CONNECT ARM

**Original Part No** MLEVP0241AJZZ

**Suit** VCA36,37,41,50,53,VC A53,62,63,67,72,VCH93,94,97,98,VCMH83,93,VT3428,5128

**Code** LEV0241

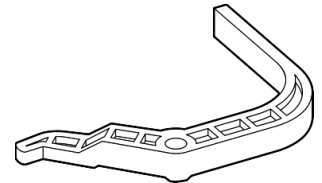

## SHARP ARM BRAKE - SUPPLY

**Original Part No** MLEVP0244AJZZ

**Suit** VCA36,37,41,50,53,VC A53,62,63,67,72,VCH93,94,97,98,VCMH83,93,VT3428,5128

**Code** LEV0244

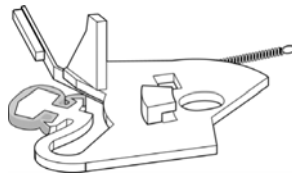

## SHARP REEL DISK

**Original Part No** NDAIV1065AJOO

**Suit** VCA36,37,41,50,53,VC A53,62,63,67,72,VCH93,94,97,98,VCMH83,93,VT3428,5128

**Code** RD1065

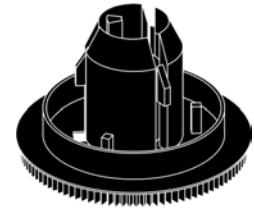

## SHARP ARM BRAKE - TAKE-UP

**Original Part No** MLEVP0242AJZZ

**Suit** VCA36,37,41,50,53,VC A53,62,63,67,72,VCH93,94,97,98,VCMH83,93,VT3428,5128

**Code** LEV0242

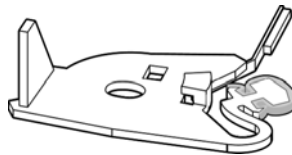

## SHARP DRIVE LEVER

**Original Part No** MLEVF0419AJZZ

**Suit** VCA36,37,41,50,53,VC A53,62,63,67,72,VCH93,94,97,98,VCMH83,93,VT3428,5128

**Code** LEV0419



## SHARP SLOW BRAKE

**Original Part No** MLEVP0250AJZZ

**Suit** VCA36,37,41,50,53,VC A53,62,63,67,72,VCH93,94,97,98,VCMH83,93,VT3428,5128

**Code** LEV0250

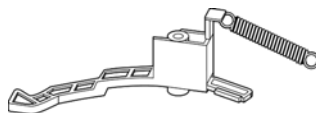

## SHARP MID-DRIVE HOUSE LEFT

**Original Part No** LHLDX1027GEZZ

**Suit** VCA36X, etc....

**Code** LDX1027

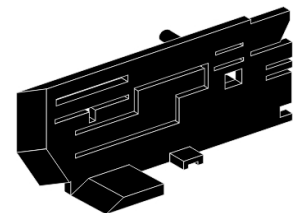

## SHARP PINCH DRIVE CAM

**Original Part No** NGERH1216AJZZ

**Suit** VCA36,37,41,50,53,VC A53,62,63,67,72,VCH93,94,97,98,VCMH83,93,VT3428,5128

**Code** GR1216

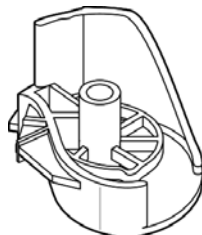

## SHARP MID-DRIVE GEAR

**Original Part No** NGERW1052GEZZ

**Suit** VCA36X, etc.

**Code** GR1052

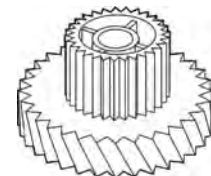

## SHARP LOCK LEVER - TAKE-UP

**Original Part No** MLEVP0249AJZZ

**Suit** VCA36,37,41,50,53,VC A53,62,63,67,72,VCH93,94,97,98,VCMH83,93,VT3428,5128

**Code** LEV0249

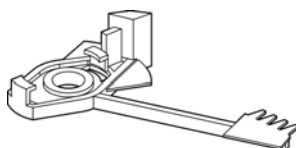

## SHARP MID-DRIVE ARM

**Original Part No** MARMP0053GEZZ

**Suit** VCA36X, etc.

**Code** ARM53

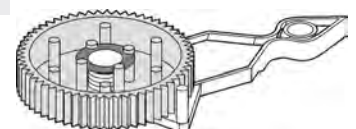



## SHARP POLE BASE - SUPPLY

Original Part No LPOLM0050GEZZ  
 Suit VCA36,37,41,50,53,VC A53,62,63,67,72,VCH 93,94,97,98,VCMH83, 93,VT3428, 5128  
 Code SPB0050

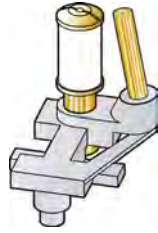

## SHARP POLE BASE - TAKE-UP

Original Part No LPOLM0051GEZZ  
 Suit VCA36,37,41,50,53, VCA53,62,63,67,72 ,VCH93,94,97,98,V CMH83, 93,VT3428, 5128  
 Code TPB0051

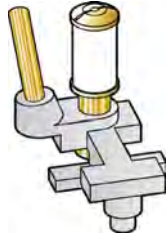

## SHARP GEAR

Original Part No NGERH1196GEZZ  
 Suit VCH91X VT3418 VT5118  
 Code GR1196

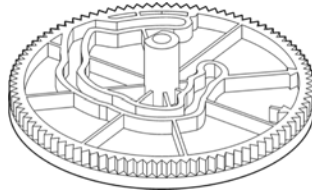

## SHARP GEAR

Original Part No NGERH1280GEZZ  
 Code GR1280

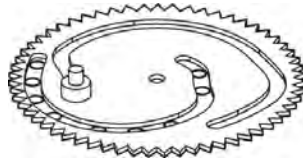

## SHARP BREAK LEVER

Original Part No MLEVP0279AJZZ  
 Suit VCA200  
 Code LEV0279



## SHARP BREAK LEVER

Original Part No MLEVP0280AJZZ  
 Suit VCA200  
 Code LEV0280

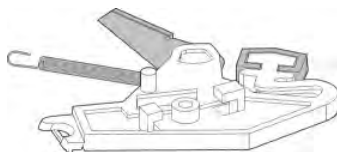

## SHARP PULLEY

Original Part No NPLYV0163GEZZ  
 Suit VCA220, 270, VCA420, 470.  
 Code PLY0163

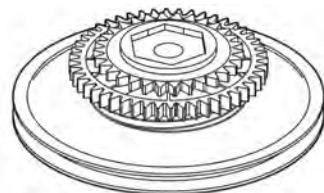

## SHARP IDLER

Original Part No NIDR0015AJZZ  
 NIDR0015GEZZ  
 Suit VCA200, 250,VCA400, 460. VCH600, 650,VT3448, 5148  
 Code GIA0015



## SHARP IDLER

Original Part No NIDR0018AJZZ  
 NIDR0018GEZZ  
 Suit VCA220, 270,VCA420, 470.  
 Code GIA0018

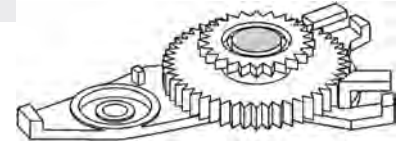

## SHARP LEVER

Original Part No MLEVP0301GEZZ  
 Suit VCA220, 270,VCA420, 470.  
 Code LEV0301



## SHARP SLIDE PLATE

Original Part No MSLIP0010AJZZ  
 MSLIP0010GEZZ  
 Suit VCA220, 270,VCA420, 470.  
 Code PS0010

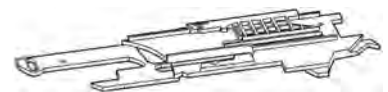

## SHARP GEAR

Original Part No NGERH1270GEZZ  
 Suit VCA650  
 Code GR1270

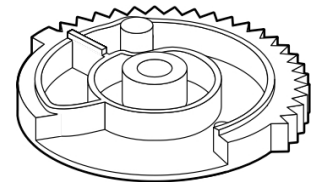

## SHARP GEAR

Original Part No NGERH1271GEZZ  
 Suit VCH650  
 Code GR1271

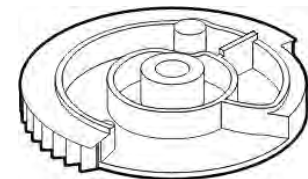

## SHARP CASSETTE HOLDER

Original Part No LHLDX1031AJZZ  
 Suit VCA200  
 Code LDX1031

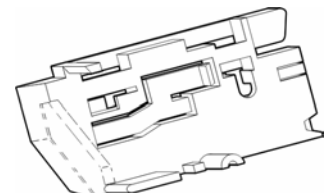



## SHARP CASSETTE HOLDER

Original Part No LHLDX1030AJZZ  
 Suit VCA200, 250, VCA400, 450, VCA600, 650.  
 Code LDX1030

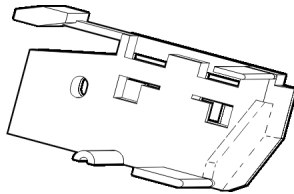

## SHARP HOUSING PANEL

Original Part No LHLDX1028AJZZ  
 Suit VCA650  
 Code LDX1028

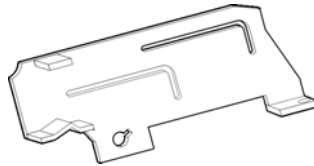

## SHARP CAM LEVER

Original Part No MLEVP0237GEZZ  
 Suit VCA36, 41, 50, 53, VCA62, 66, 67, 72, VCH83, 93, 94, 97, VCMH80, 83, 93, VT3428, 5128, etc.  
 Code LEV0237

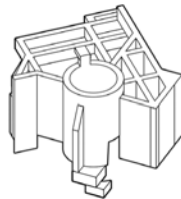

## SHARP BRAKE TAKE-UP

Original Part No series videos MLEVP0128GEZZ  
 Suit most VCA, VCB, VCD, VCH, VCS, VCT, and VR, VT  
 Code LEV0128

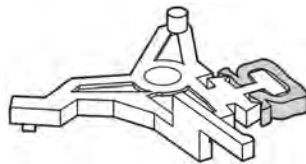

## SHARP BRAKE SUPPLY

Original Part No series videos MLEVP0129GEZZ  
 Suit most VCA, VCB, VCD, VCH, VCS, VCT, and VR, VT  
 Code LEV0129



## SHARP MASTER CAM GEAR

Original Part No NGER1295AJ00  
 Suit VCA240, 290, VCA490, etc.  
 Code GR1295



## SHARP PULLEY

Original Part No NPLYV0162GEZZ  
 Suit VCA220, 470, VCA550, etc. VCH680, 705, VCH800, etc.  
 Code PLY0162

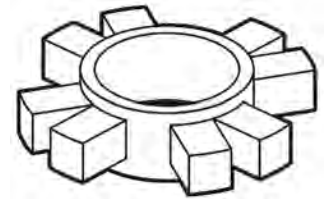

## SHARP LEVER

Original Part No MLEVP0336AJZZ  
 Suit VCA220, 470, VCA550, etc. VCH680, 705, VCH800, etc.  
 Code LEV0336

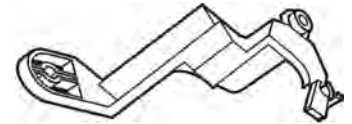

## □ Sony

## SONY

Very early VHS Models were manufactured by Sanyo.



## SONY ARM ASSEMBLY

Original Part No X3727-776-1 X3749-173-4  
 Suit SLV215, 353, SLV75, 7, 777, SLVX30, X50, SLVX810, etc.  
 Code GIA7761

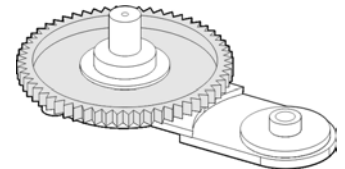

## SONY GEAR

Original Part No 3-736-116-01  
 Suit SLV215, 353, SLV75, 7, 777, SLVX30, X50, SLVX810, etc.  
 Code GR1601

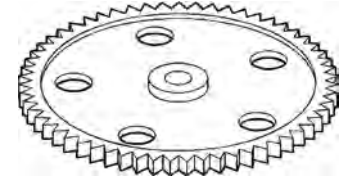

## SONY CAM GEAR

Original Part No 3-736-143-01  
 Suit SLV215, 353, SLV75, 7, 777, SLVX30, X50, SLVX810, etc.  
 Code GR4301

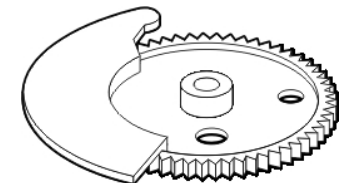

## SONY PRESS CAM

Original Part No 3-736-135-01  
 Suit SLV353, 757, SLVX30, X50,  
 Code GR3501

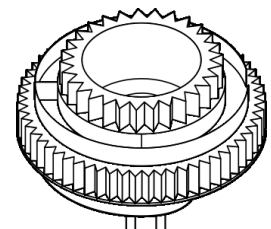



## SONY GEAR

Original Part No 3-943-700-01  
 Suit SLV215,SLVX35,X55,SLVX810,etc.  
 Code GR7701

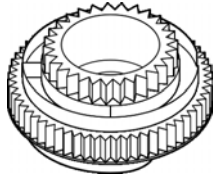

## SONY PULLEY

Original Part No X3727-782-1  
 Suit SLV215,353,SLV757,777,SLVX30,X50,SLVX810,etc.  
 Code GR7821

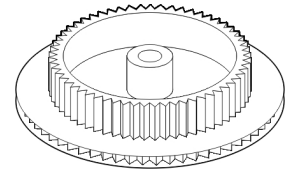

## SONY WHEEL WORM

Original Part No 3-736-015-01  
 Suit SLV215,353,SLV757,777,SLVX30,X50,SLVX810,etc.  
 Code GR1501

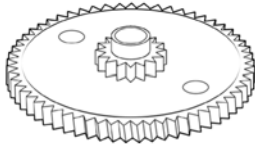

## SONY GEAR

Original Part No X3727-795-1  
 Suit SLV215,353,SLV757,777,SLVX30,X50,SLVX810,etc.  
 Code GR7951

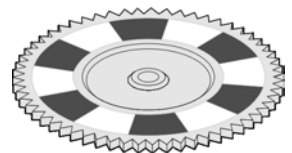

## SONY CAM GEAR

Original Part No 3-736-170-01 3-736-170-03  
 Suit SLV215,353,SLV757,777,SLVX30,X50,SLVX810,etc.  
 Code GR7001

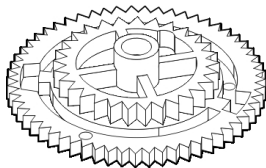

## SONY CLEANING ROLLER

Original Part No A6747-264-A A6747-267-A  
 Suit SLVX30, SLV215, 777,SLVX50, 810,etc.  
 Code ARM264 ARM267

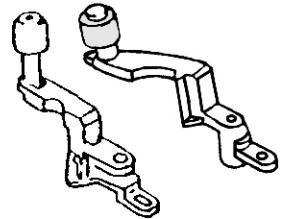

## SONY CAM GEAR

Original Part No 3-736-176-01  
 Suit SLV215,353,SLV757,777,SLVX30,X50,SLVX810,etc.  
 Code MCG7601

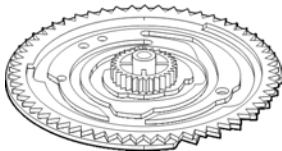

## SONY CAM ELEVATOR

Original Part No 3-952-182-01,3-736-136-01  
 Suit SLV215,353,SLV757,777,SLVX30,X50,SLVX810,etc.  
 Code GR8201



## SONY CAM GEAR

Original Part No 3-733-394-01  
 Suit SLV215,353,SLV757,777,SLVX30,X50,SLVX810,etc.  
 Code GR3940

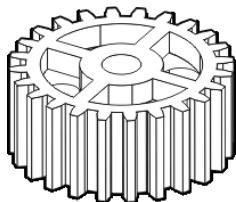

## SONY STOPPER

Original Part No 3-736-111-01  
 Suit SLV215,353,SLV757,777,SLVX30,X50,SLVX810,etc.  
 Code STP1101

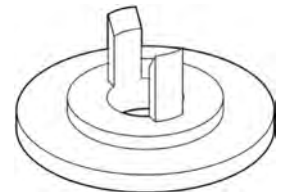

## SONY GEAR RIGHT THREADING

Original Part No 3-736-148-01  
 Suit SLV215,353,SLV757,777,SLVX30,X50,SLVX810,etc.  
 Code GR4801

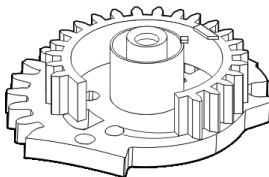

## SONY ARM BLOCK

Original Part No A6759074P  
 Code GR5074

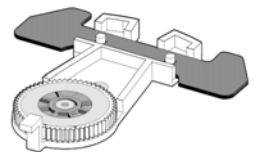

## SONY GEAR

Original Part No 3-736-147-01  
 Suit SLV215,353,SLV757,777,SLVX30,X50,SLVX810,etc.  
 Code GR1470

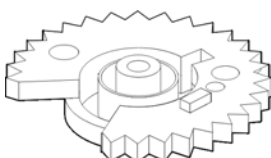

## SONY CHASSIS BLOCK

Original Part No A6739-084-A  
 Suit SLVX55  
 Code MEC9804

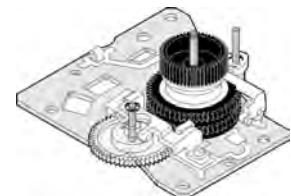





## SONY PLATE SLIDE MODE

Original Part No 3-736-177-01  
 Suit SLV215,353,SLV757,777,SLVX30,X50,SLVX810,etc.  
 Code PSM7701

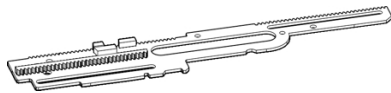

## SONY ELEVATOR CAM

Original Part No 3-958-151-01  
 Suit SLV, SLVT,SLVX Series  
 Code CAM5101



## SONY ARM TENSION REGULATOR

Original Part No 3-736-142-01  
 Suit SLV757  
 Code ARM4201

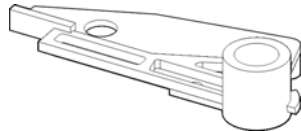

## SONY WORM WHEEL

Original Part No 3-958-157-01  
 Suit SLV, SLVT,SLVX Series  
 Code GR7010

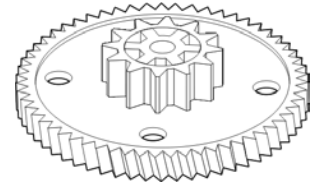

## SONY ARM

Original Part No 373614001  
 Suit SLV757,SLVX811  
 Code ARM4001



## SONY GEAR

Original Part No 3-958-152-01  
 Suit SLV, SLVT,SLVX Series  
 Code GR5201

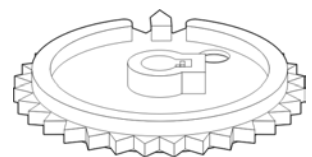

## SONY LOAD GEAR

Original Part No 3-946-922-01  
 Suit SLVX37,SLVX57.  
 Code GR2201

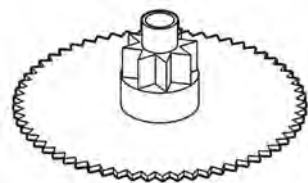

## SONY LOAD GEAR SUPPLY

Original Part No 3-958-476-01  
 Suit SLV, SLVT,SLVX Series  
 Code GR7601

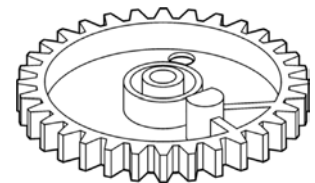

## SONY MECH

The following parts are from SONY mechanism to suit SLV7000, SLVT2000 SLVX315, 317, 325,SLVX327, 335, 425,SLVX427, 515, 517,SLVX522, 525, 527,SLVX825, 835, and maybe more we are unaware of!

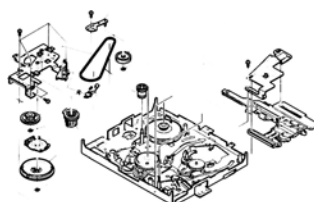

## SONY GEAR PRESS

Original Part No 3-958-153-01  
 Suit SLV, SLVT,SLVX Series  
 Code GR5301

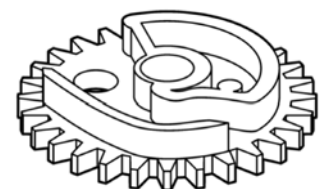

## SONY ROLLER ASSEMBLY [CLEANER]

Original Part No Sony X-3944-363-1  
 Suit SLV7000,SLVK872,SLVT2000,SLVX312,SLVX315....842  
 Code RL3631



## SONY LOAD GEAR TAKE-UP\*

Original Part No 3-958-485-01,3-958-485-02  
 Suit SLV, SLVT,SLVX Series  
 Code GR8502

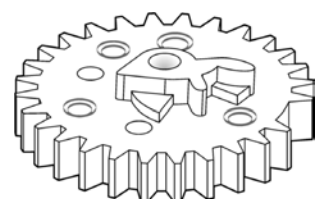

## SONY REEL DRIVE ASSEMBLY

Original Part No A-6739-102-A  
 Suit SLV, SLVT,SLVX Series  
 Code GIA9102

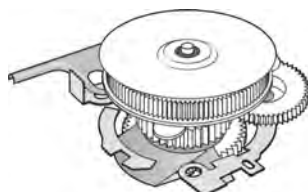

## SONY GEAR\*

Original Part No 3-958-162-01,3-958-162-02  
 Suit SLV, SLVT,SLVX Series  
 Code GR6202





# Video Repair Parts

## SONY PLATE SLIDE MODE\*

Original 3-958-163-04,  
Part No 3-958-163-01  
Suit SLV, SLVT,SLVX  
Series  
Code LEV6304

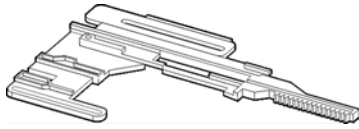

## SONY CAM GEAR (OLD)

Suits OLD FRONT LOAD DRIVE  
GEAR (No Longer Available from  
Sony.) See KIT5602 Below if  
replacing both cam and gear, etc.

Original 3-958-161-01,  
Part No 3-958-161-04  
Code CAM6104

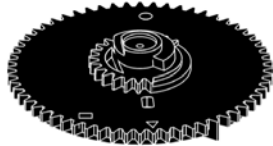

## SONY CENTRE GEAR

Suit SLVED225 825, 925, 929,  
SLZEZ121, 424, 727, etc.  
Code GRC2058

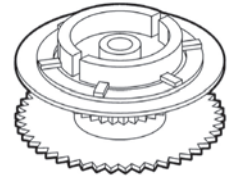

## SONY FRONT LOAD DRIVE GEAR KIT\*\*

3-958-156-02 Gear Sony Is no longer  
available! Sony recommends 'Must  
use this kit to avoid "No tape loading or  
eject" problem when replacing GR5603 '  
\*Includes gears & slide plate.

Suit SLV,T,X Series, etc.  
Code KIT5602



## SONY FRONT LOAD DRIVE GEAR (NEW)\*

Original 3-958-156-01,  
Part No 3-958-156-03  
Suit SLV, SLVT,SLVX  
Series  
Code GR5603

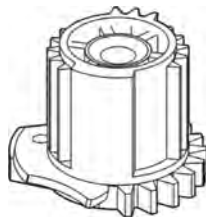

Use only with CAM6107  
(See info KIT5602 above!)

## SONY CAM GEAR (NEW)\*

Original 3-958-161-07  
Part No  
Suit SLV, SLVT,SLVX  
Series  
Code CAM6107

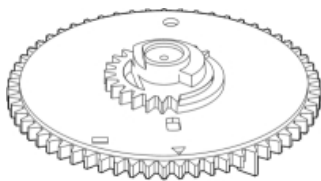

Use only with GR5603  
(See info KIT5602 above!)

## SONY SWITCH MODE

Original 1-413-896-21 1-413-897-11  
Part No  
Code PS9621 PSM9711

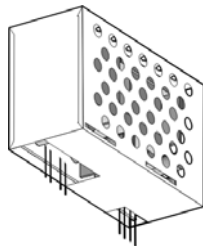

## SONY POWER SUPPLY

1-413-621-11  
Complete module  
from power cord to  
Connection sockets

Suit SLV777  
Code PSM2111

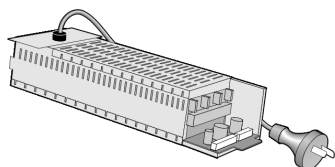

## SONY ARM OPEN LID

Original 397751401  
Part No  
Suit SL-VEZ1, 10,SL-VEZ7,  
70.  
Code ARM1401



## SONY PINCH PRESS GEAR

Original 397744101  
Part No  
Suit SL-VEZ1, 10,SL-VEZ7,  
70.  
Code GR4103



## SONY TG8 DRIVE GEAR

Original 397744501, , New,  
Part No 397744103  
Suit SL-VEZ1, 10,SL-VEZ7,  
70.  
Code GR4502



## SONY TG8 SUPPLY GEAR

Original 397744601  
Part No  
Suit SL-VEZ1, 10,SL-VEZ7,  
70.  
Code GR4601



## SONY CLEANING ROLLER

Original X39472551  
Part No  
Suit SL-VEZ1, 10,  
SL-VEZ7, 70.  
Code RL2551





## SONY LOAD GEAR TAKE-UP

Original Part No 397745501,  
397745502,  
NEW, 397745503  
Suit SL-VEZ1, 10,  
SL-VEZ7, 70.  
Code GR5503



## SONY LOAD GEAR SUPPLY

Original Part No 397745101  
Suit SL-VEZ1, 10,  
SL-VEZ7, 70.  
Code GR5501



## SONY GEAR ASSEMBLY & PULLEY

Original Part No X397745101  
Suit SL-VEZ1, 10,  
SL-VEZ7, 70.  
Code GR5851



## SONY LOAD SLIDE GEAR

Original Part No 397744201,  
397744202,  
397744203  
Suit SL-VEZ1, 10,  
SL-VEZ7, 70.  
Code GR4202

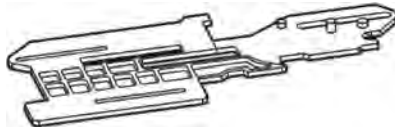

## SONY REEL DIRECT GEAR

Original Part No X39475841  
Suit SL-VEZ1, 10,  
SL-VEZ7, 70.  
Code GR5841



## SONY CAMCORDER REEL [T]

Original Part No X-3727-951-9  
Suit CCD-V888E and  
others. Take-Up reel  
clutch assembly.  
Code RT9519

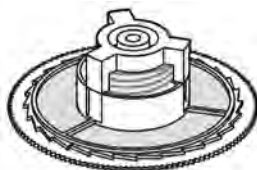

## Toshiba

### TOSHIBA IDLER

Original Part No 70326538  
Code VIA820



## Teac / Philips

### TEAC / PALSONIC / FUNAI / GOLDSTAR / LG

Rebadging technology  
AND NOW PHILIPS



### PHILIPS TEAC GEAR KIT

Original Part No 4822 3101 0657  
Suit MV7, 77, 777, RTV250,  
256, 350, RTV356, 725,  
785, VR9489.  
Code GR10657

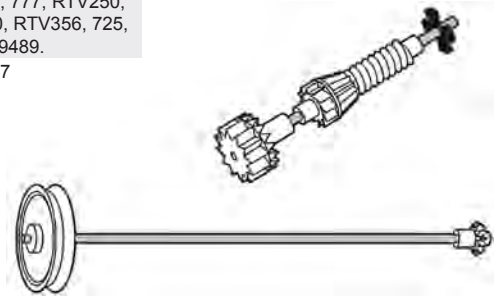

### TEAC/PHILIPS VCR SERVICE KIT-i

Original Part No 4822-310-31963  
Suit GR560, GV540,  
MV7, 77, 777,  
RTV250, 256, 350,  
RTV456, 725, 785,  
VR9489/39.  
Code ES7118



### TEAC/PHILIPS VCR SERVICE KIT-b

Original Part No 4822-310-31955  
Suit GR560, GV540, MV7,  
77, 777, RTV250, 256,  
350, RTV456, 725, 785,  
VR9489/39.  
Code ES7111



### TEAC/PHILIPS CLEANING ROLLER

Original Part No 4822-528-70773  
Suit GR560, GV540, MV7,  
77, 777, RTV250, 256,  
350, RTV456, 725, 785,  
VR9489/39.  
Code RL7730







## □ Cassette Housings

### □ Akai

#### AKAI CASSETTE LOAD ASSEMBLY

Original Part No BV-V1102A150A

Suit VS422, VS425, VS765, VSA650, VSF10, VSF11, VSF12, VSF650, etc.

Code CH1102

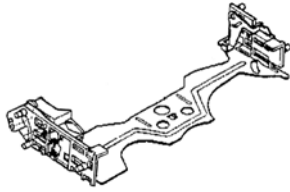

### □ Daewoo / Tempest

#### DAEWOO TEMPEST CASSETTE HOUSING

Original Part No 97SA104100, 97SA104110

Suit DVR6158, VCR32, 52, VCR8025, TE970R, 99R.

Code CH8025



### □ Funai / Teac / Palsonic

#### FUNAI TEAC PALSONIC CASSETTE HOUSING

Original Part No 62D806516301

Suit MV3010, 3030, 3050, MV4010, 6010, Palsonic VCR9688

Code CH6301



### □ LG / Goldstar

#### GOLDSTAR CASSETTE HOUSING

Original Part No 219-011A, 219-004A

Suit AV62, GHV1241, 46, 47, GHV51, KBV9012, M22, VCR7000, VR1500, etc.

Code CH9011

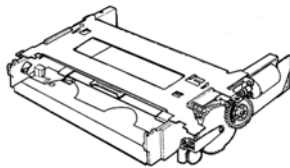

#### GOLDSTAR CASSETTE HOUSING

Original Part No 219-015B, 219-010B

Suit AV65, GHV1290, 91, 92, 93, GHV1392, 93, 1910, VCP4200, 4300, VCP4305, 4306.

Code CH9015

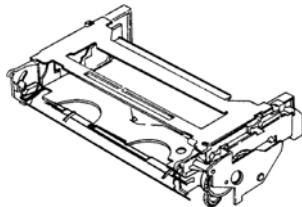

#### GOLDSTAR CASSETTE HOUSING

Original Part No 219-017B, 219A017F

Suit AV66, RG20

Code CH2190

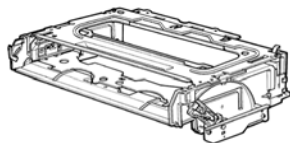

### □ JVC / Philips

#### JVC CASSETTE HOUSING

Suit HRD540, 580, 920, HRDX20, 42, VR3241, etc.

Code PUS29499B

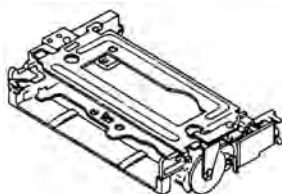

#### JVC CASSETTE HOUSING

Suit HRD520EA HRDX22

Code PUS29499C PUS29499E

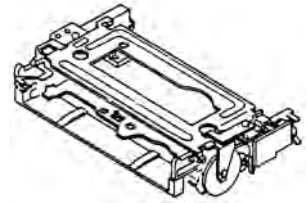

#### JVC CASSETTE HOUSING

Suit HRD640, 910. HRJ200, 400.

Code PUS29499D PUS29672A-5

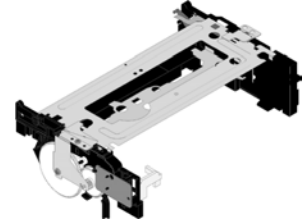

#### JVC CASSETTE HOUSING

Suit HRJ600

Equiv. PUS29662A4

Code PUS29662C1

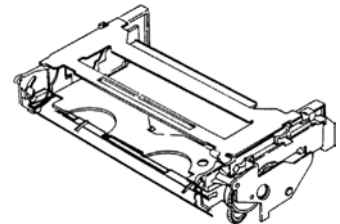

#### JVC CASSETTE HOUSING

Original Part No PUS26805U

Suit HRD140, 141, 142, HRD143, 150, 250, HRD455, 565, 566, HRD725, 755 and NEC N895.

Code CH2681

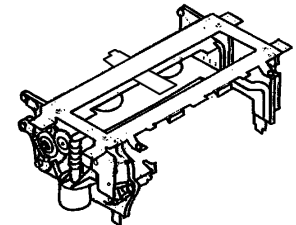

#### JVC CASSETTE HOUSING

Original Part No PUS26805Q

Suit HRD110, 111, 120, HRD121, 220, 225, RV360, 370, GE8100, 9300, N830/1/3

Code CH2680

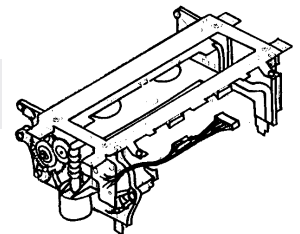

#### JVC CASSETTE HOUSING

Suit HRD170, 180, HRD160, 200, 190, etc. HRD217, 530..

Code PUS28277F PUS28277H

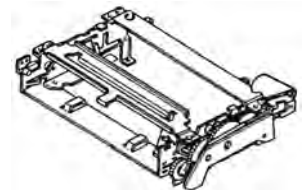

#### JVC CASSETTE HOUSING

Original Part No PUS25908D-101

Suit HR2200, HR2650

Code PUS25908

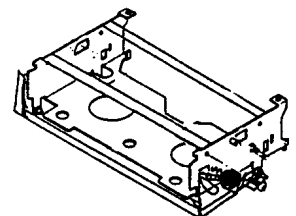





## JVC CASSETTE HOLDER

Suit HR7700  
Code PU20934A

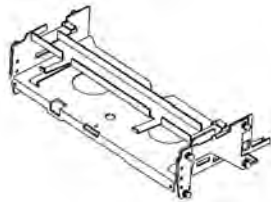

## JVC CASSETTE HOUSING

Suit HRJ220, 221,  
HRJ625, etc.  
Code PUS29724C-1

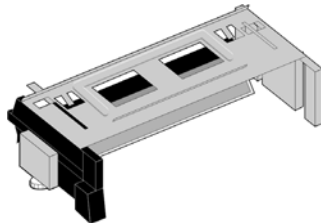

### □ Mitsubishi

## MITSUBISHI CASSETTE HOLDER

Bottom Unit.

Suit HS521, 621,  
HS640, 7424.  
Code CH1030



## MITSUBISHI CASSETTE HOUSING

Original Part No 590A256020  
Suit HSE11, HSM33, 57,  
HSM58, 68, HSM1000,  
HSMX1, X2.  
Code CH5602



### □ Panasonic

## PANASONIC HOUSING

Suit NVG10 etc.  
Equiv. VXA2562  
Code VXA2450

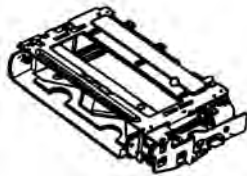

## PANASONIC DOOR KIT

Original Part No VKF0225 & Spring  
VMB1171  
Suit NV370, NV600, NV788,  
NV850, etc.  
VKF0225, VFK0266,  
Equiv. VFK0335, VFK0336,  
VKF1715, etc.  
Code VXA1806



## PANASONIC CASSETTE HOLDER

Suit NVSD10, NVF65, 66,  
20, 30 70, 90  
Equiv. VXA3832  
Code VXA4661 VXA3840

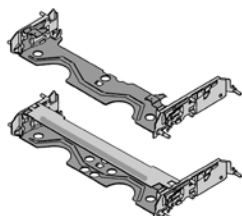

## PANASONIC SIDE PLATE

Includes opener  
lever VXL2250

Suit NVSD10A, NVSD20A,  
NVSD30A  
Code VXA4660

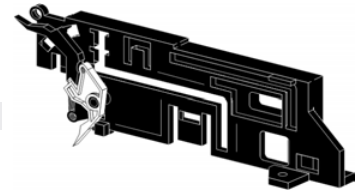

## PANASONIC SIDE PLATE

Suit NVSD10A, NVSD20A,  
NVSD30A  
Code VXA4806

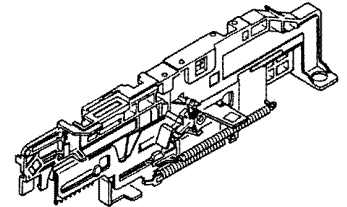

## PANASONIC SHAFT ASSEMBLY

Suit NVSD10A, NVSD20A,  
NVSD30A  
Code VXP1339



## PANASONIC SIDE PLATE

Suit NVL20, 25, NVG25, 28, NVJ45, etc.  
'G' Mech 'G' Mech  
Type 6 Pin 2+5 Pin 6+4 Pin  
Code VXA4076 VXA3015 VXA4468

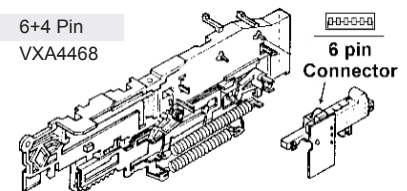

## PANASONIC SHAFT

Suit NVG33, NVH75, etc.  
Equiv. VXP0987  
Code VXP0851

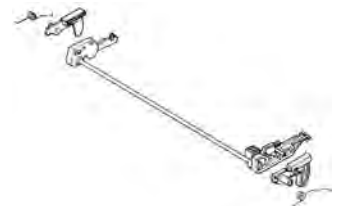

### □ Samsung

## SAMSUNG CASSETTE HOUSING

Original Part No 61227004705  
Suit VB520, 900, Akai VS200,  
Tempest TE900H  
Code CH0900



## SAMSUNG CASSETTE HOUSING

Original Part No 62052-0004-02  
Suit VB300, VB370, VB3260,  
etc.  
Code CH4020

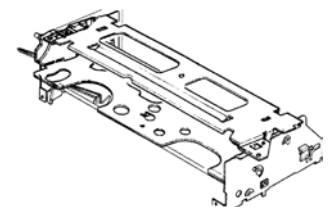



## □ Sanyo

### SANYO CASSETTE HOUSING

Original Part No 613-152-0578  
 Suit VHR510, 530, VHR630, 650.  
 Code CH2057

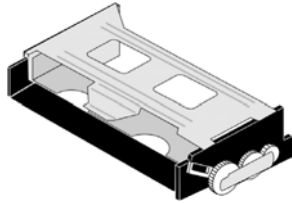

### SANYO CASSETTE HOUSING

Original Part No 613 125 4862, 613 125 5487  
 Suit SRT500, TLS1500, TLS900, 974.  
 Code CH4862



## □ Sharp

### SHARP CASSETTE HOLDER

Original Part No LHLDX3016GEZZ  
 Suit VC581, etc.  
 Code CH3016



### SHARP HOUSING ASSEMBLY

Original Part No CHLDX3039  
 Suit VC45, VCA101, VCH851  
 Code CH3039

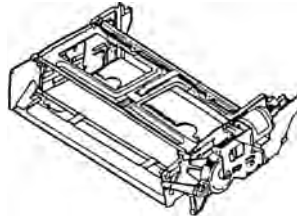

### SHARP CASSETTE HOUSING

Description	Without Cass' In SW	With Cass' In SW
Original Part No	CHLDX3050GE00	CHLDX3051GE00
Code	CH3050	CH3051

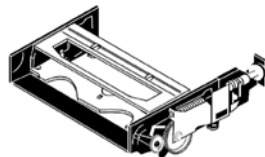

### SHARP CASSETTE HOUSING

Original Part No	CHLDX3052GE51/53	CHLDX3066GE58
Suit		VC-H91, B20, B60
Code	CH3052	CH3066

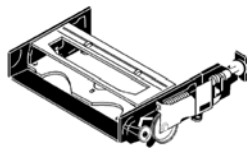

### SHARP CASSETTE HOUSING

Original Part No CHLDX3071GE02  
 Suit VCA36, 37, 41, VCA50, 53, 62, VCA67, 72, 93, VCA94, 97, 98, inc. 'X' series.  
 Code CH3071

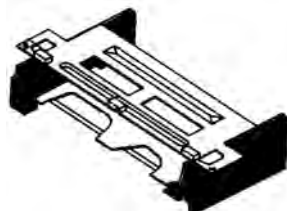

## SHARP CASSETTE HOUSING

Original Part No CHLDX3081TEV2  
 Suit VCA220, 270, VCA420, 470.  
 Code CH3081



## □ Sony

### SONY CASSETTE HOUSING

Original Part No A6751-421-A  
 Suit SLVX30, 50, 810, etc.  
 Code CH1421

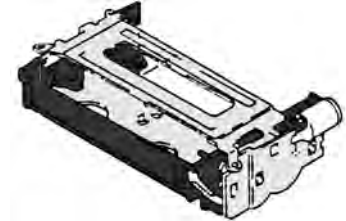

### SONY CASSETTE HOUSING

Original Part No A6751-445-A, A6751-455-A, A6751-455-G  
 Suit SLVX55, 710.  
 Code CH1445

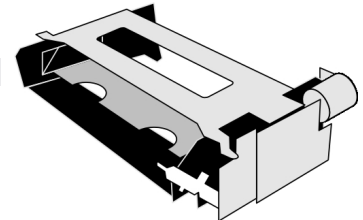

### SONY CASSETTE HOUSING

Original Part No	A6751-426-A	A6751-453-A
Suit	SLV777	SLV215, 353, etc.
Code	CH1426	CH1453

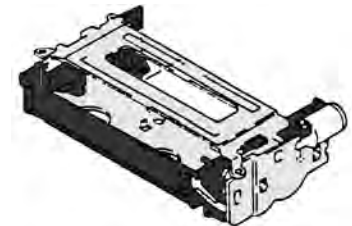

### SONY CASSETTE HOUSING

Original Part No A6751496A, A6759603A, A6759623A, A6775357A  
 Suit SLVX812, SLVX822  
 Code CH9623

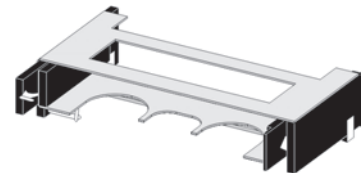

### SONY CASSETTE HOUSING

Original Part No A6759619B, New A6759619C  
 Suit SL-VEZ1, 10, SL-VEZ7, 70.  
 Code CH9619





## □ Tension Bands

### □ Akai

#### VIDEO TENSION BANDS



#### AKAI TENSION BAND

Original Part No VT328134  
 Suit VS3, etc.  
 Code TB3281

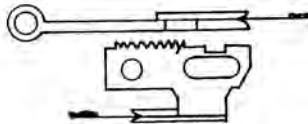

#### AKAI TENSION BAND

Original Part No ML500881  
 Suit VS22, 23, 25, 35, 37, 38, 53, 55, 66, 75  
 Code TB5008

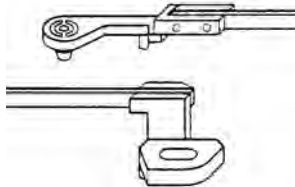

#### AKAI TENSION BAND

Original Part No BLB360350  
 Suit VS112, VS165, 505  
 Code TB3603



#### AKAI TENSION BAND

Original Part No BVB35237  
 Suit VS303, 603, VS606, 607, etc.  
 Code TB2377

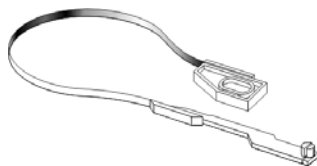

#### AKAI TENSION BAND

Original Part No MZ420016N2  
 Suit VSG204, ..., 212, VSG405, 511, VSG2100, etc.  
 Code TB4200

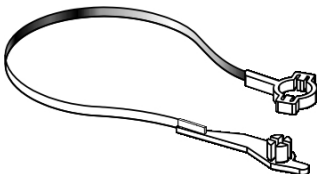

#### AKAI TENSION BLOCK

Original Part No BL4335386  
 Suit VSG280, VSG2DPL, VSG765, 790, 875.  
 Code ARM5386

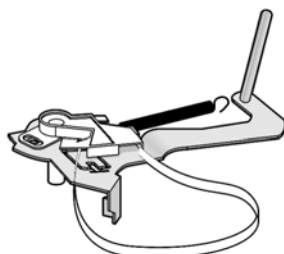

## □ Funai / Teac / Palsonic

#### FUNAI TENSION BAND

Original Part No 8059-08-302  
 Suit MV435, 445, VX2000, etc.  
 Code TB8302

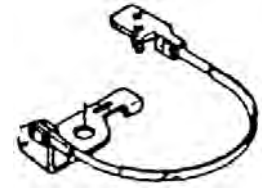

#### FUNAI TEAC PALSONIC TENSION BAND

Original Part No 62D806508303  
 Suit MV3010, 3030, 3050, MV4010, 6010, Palsonic VCR9688  
 Code TB8303

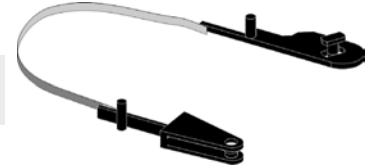

#### FUNAI TEAC TENSION BAND

Original Part No OVSA08816  
 Suit MV3420, MV4820.  
 Code TB8816



#### FUNAI TEAC TENSION BAND

Original Part No OVSA-04658  
 Suit MV3410, MV4810T  
 Code TB4658



## □ LG / Goldstar

#### GOLDSTAR TENSION BAND

Original Part No 328-017B  
 Code TB8017

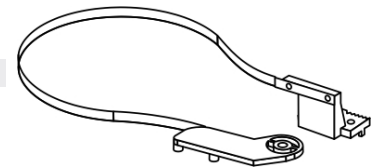

#### GOLDSTAR TENSION BAND

Original Part No 328-033B  
 Code TB8033

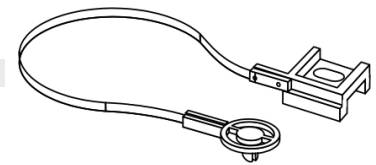

#### GOLDSTAR / NEC TENSION BAND

Original Part No 333-329A, 328-075A, NEC 79VG0998, VN36  
 P23H, P433H, P933H, RN800H, RN830H, T293H, T493H, VHG104, VNG67.  
 Code TB3329

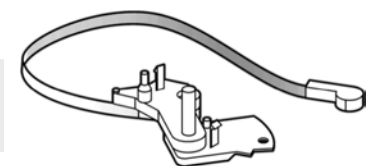

#### GOLDSTAR / LG TENSION BAND

Original Part No 4770R-0004A  
 Suit VSJ200, 215, 411, VSJ700, 711, 716, LG AF293, 493, 993, AC250, 450, 950.  
 Code TB0004





## Hitachi

### HITACHI TENSION BAND

Original 7413665  
 Part No  
 Suit VTF778E  
 Code TB3665

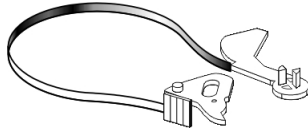

## JVC

### JVC TENSION BAND

Suit HRD170,180,  
 210,217,300,321,  
 370,400,440,441,  
 470,500,530,700,  
 HRS5000,9000 etc.  
 Code PQ41948A

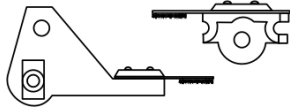

### JVC TENSION BAND

Suit HRD140,141,  
 142,143,150,152,  
 156,157,160,250,  
 257,565,566,755,  
 Code PQ41370B

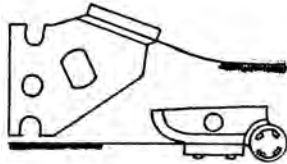

### JVC TENSION BAND

Suit HRD520,521, 540,580,600,  
 610,620,830,  
 Code PQ43501

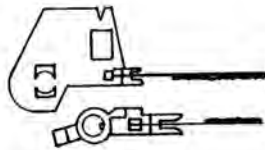

### JVC TENSION BAND

Equiv. PQ44734A-1  
 Suit HRD640, HRD910  
 Code PQ45527A-1

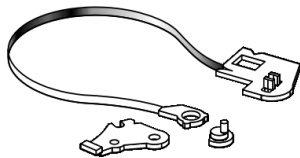

### JVC TENSION BAND

Suit HR7200,7300,7600,7650,  
 HRD110,111,120,121,225,  
 HV4000,8000,VCR1500,  
 N830,831,833,  
 RV340,350,360,370.  
 Code PU51390A

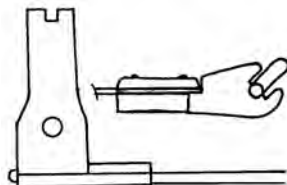

### JVC TENSION BAND

Suit HR3300,3330,  
 3660,3600,4100,  
 HV1000,2000,3000,  
 RV300,310,320,  
 Code PUS45904A

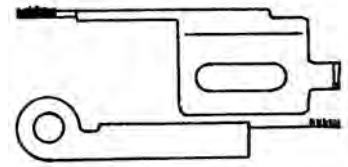

### JVC TENSION BAND

Suit HRD455,725 NEC  
 N895 TOSHIBA V63  
 Code PQ40262E

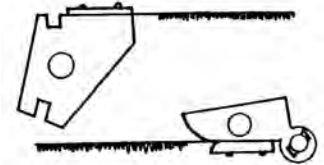

### JVC TENSION BAND

Suit HR2200, HR2650  
 Code PU48784B

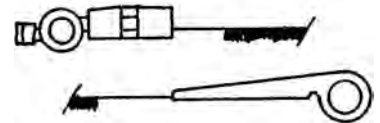

### JVC TENSION BAND

Suit HRC3  
 Code PU52993A

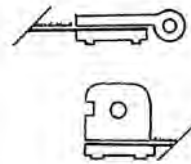

### JVC TENSION BAND

Original PQ46298A-3,  
 Part No PQ46298A-5  
 Suit HRJ220, HRJ221,  
 HRJ625  
 Code PQ46298

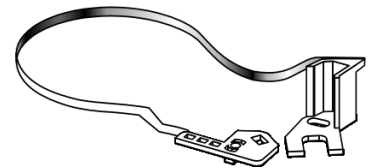

### JVC TENSION BAND

Suit HRJ600  
 Code PQ34629A-3

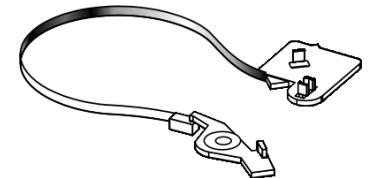

## Mitsubishi

### MITSUBISHI TENSION BAND

Original 591B552010  
 Part No  
 Suit HSJ11,41, HSMX1,2  
 Code TB2010

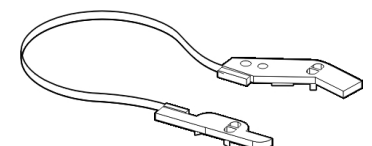





## MITSUBISHI TENSION BAND

Original Part No 614B62402, 614B624020  
 Suit HSM50,X3, HSMX5,X7, HSMX10,20.  
 Code TB2402

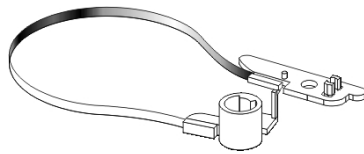

## MITSUBISHI TENSION BAND

Original Part No 621C557010  
 Suit HS521, 621, HS640, 7424.  
 Code TB7010



## NEC

### NEC TENSION BAND

Original Part No 16183551  
 Suit DX1600,2000, DX3000,9053, DX9055,9066  
 Code TB3551

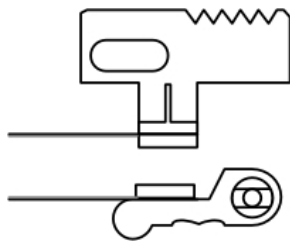

### NEC TENSION BAND

Original Part No 16177851  
 Suit DX9012,9014, DX9016,9033,  
 Code TB7851

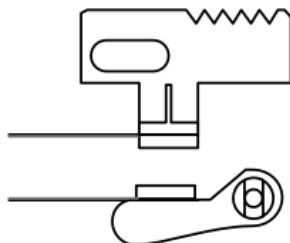

### NEC TENSION BAND

Original Part No 16188802  
 Suit N9402A  
 Code TB8802

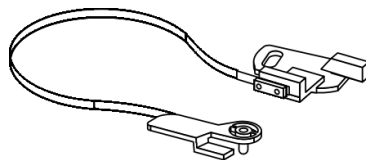

### NEC TENSION BAND

Original Part No 79TD3959, DaeWoo 97SB382900  
 Code TB2900

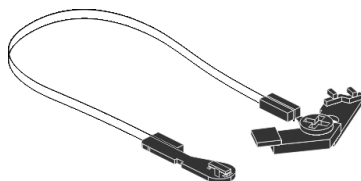

## Panasonic

### PANASONIC TENSION BAND

Suit NV7000,7200, NV7500 and BLAUPUNKT RTV222  
 Code VXZ0078

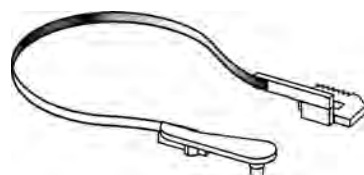

## PANASONIC TENSION BAND

Suit NV300, 600, NV777, etc. AG6200, RTV321.  
 Code VXZ0129



## PANASONIC TENSION BAND

Suit NV250 etc. NV-G10 etc.  
 Code VXZ0165

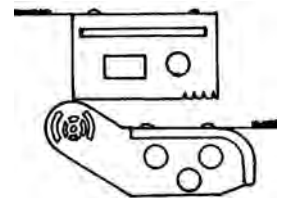

## PANASONIC TENSION BAND

Suit NVG20, etc.  
 Code VXZ0267

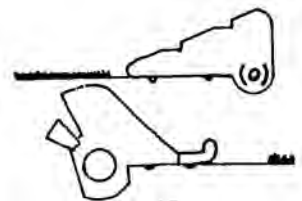

## PANASONIC TENSION BAND

Suit NVSD10A, NVSD20A, NVSD30A  
 Code VXZ0310

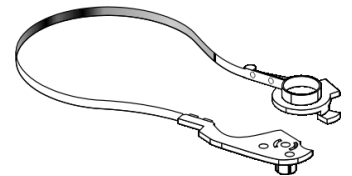

## PANASONIC TENSION BAND

Original Part No VXL2671, VXL2793  
 Suit NVSD220, 270, NVSD420, NVHD620, 670.  
 Code VXL2671

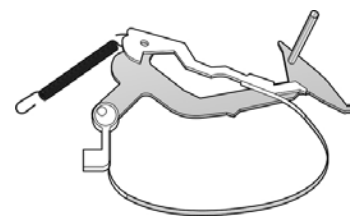

## Samsung

### SAMSUNG TENSION BAND

Original Part No 6202 400 0501  
 Suit VB300, VB370 & More.  
 Code TB5001

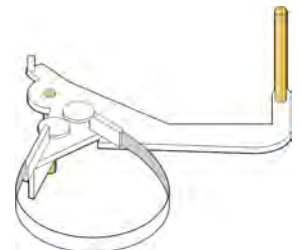

### SAMSUNG TENSION BAND

Original Part No 61543-0071-00V  
 Suit SV10,11,12, SV30,80,140  
 Code TB7100

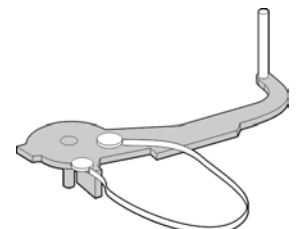



## □ Sanyo

### SANYO TENSION BAND

Original Part No 143-0-711T  
 Suit VHR110, 13  
 Code TB2000

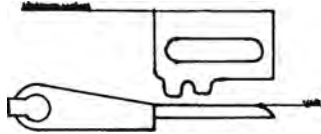

### SANYO TENSION BAND

Original Part No 613-160-5282  
 Suit VHR510, 530, VHR590, 610, VHR630, 650  
 Code TB5282

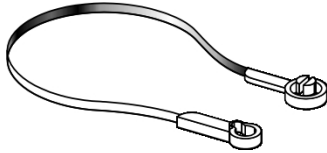

### SANYO TENSION BAND

Original Part No 613-021-9701  
 Suit VHR4100, etc.  
 Code TB9701

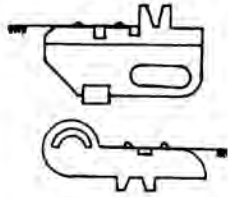

### SANYO TENSION BAND

Original Part No 1430711T02101, Also 1430711T02100, Also 613-037-5377  
 Suit VHR3300, D500, etc.  
 Code TB2101

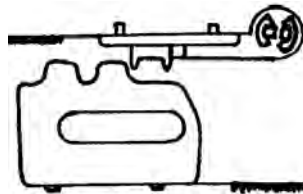

### SANYO TENSION BAND

Original Part No 143-2-5204-01500  
 Suit FVH-P620, 710, etc.  
 Code TB1500

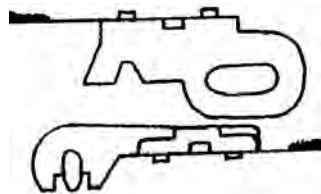

### SANYO TENSION BAND

Original Part No 1430711T02021  
 Suit VHR2100, VHR2300, VHR2500, VHR2700, etc.  
 Code TB2021

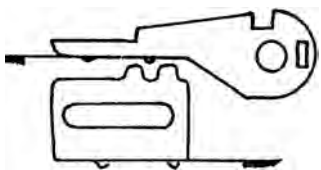

### SANYO TENSION BAND

Original Part No 613-100-4573  
 Suit SRT500P, TLS900P, TLS924P, TLS2000, TLS2500P  
 Code TB4573

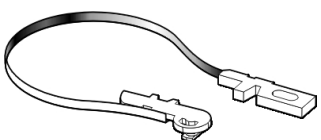

## □ Sharp

### SHARP TENSION BAND

Original Part No LBNDK1002GEZZ.  
 Suit VCA10, 30, 60, 103, 105, 106, 111, 505, 605, D810, VCH80, VR6443, 6448,  
 Code DK1002

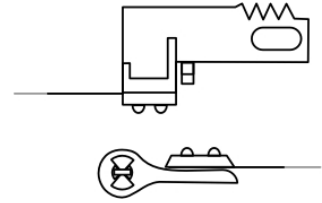

### SHARP TENSION BAND

Original Part No LBNDK3011GEZZ, Philips 480240117243  
 Code DK3011

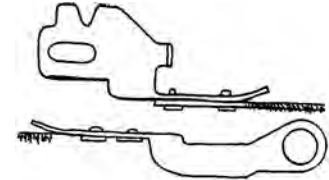

### SHARP TENSION BAND

Original Part No PBRKZ0003GEZZ, LBNDK1001GEZZ  
 Suit VC200X, 820X, 600/700 series & Philips equiv.  
 Code TB0003

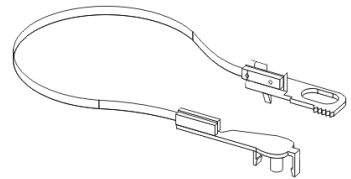

### SHARP TENSION BAND

Original Part No LBNDK3008GEZZ  
 Suit VC7300, VC7700, etc.  
 Code DK3008

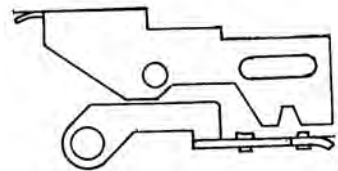

### SHARP TENSION BAND

Original Part No LBNDK3014GEZZ, 480240357605  
 Suit 300, 400, 500, 6000 and Philips  
 Code DK3014

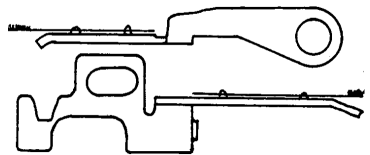

### SHARP TENSION BAND

Suit VCA36, 37, 41, VCA50, 53, 62, VCA67, 72, VCH94, 97, 98, VCMH38, H93.  
 Code DK1008

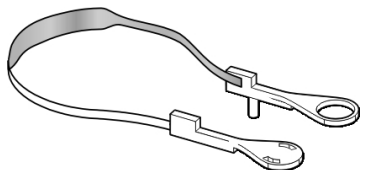

### SHARP TENSION BAND

Original Part No LBNDK1011AJZZ  
 Suit VCA220, 270, VCA420, 470.  
 Code DK1011

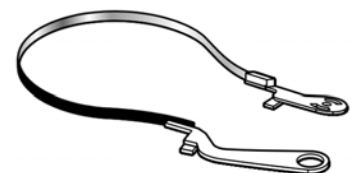



## SHARP TENSION BAND

Original LBNDK1009GEZZ  
 Part No  
 Suit VCH650X  
 Code DK1009

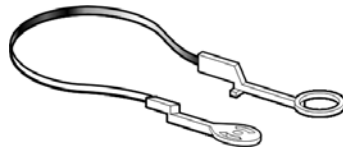

## AKAI PUSH SWITCH

Original ES349367  
 Part No  
 Code SW9367

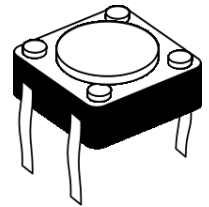

Others see Section 10  
 ELECTRONIC COMPONENTS

### □ Sony

## SONY TENSION BAND

Original X3727-797-1  
 Part No  
 Suit SLV215, 353, SLV757,  
 777, SLVX30, X50,  
 SLVX810, etc  
 Code TB7971

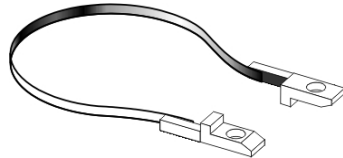

## AKAI SWITCH

Original ES-348089J1  
 Part No  
 Suit VS4  
 Code SW3480



## SONY TENSION BAND

Original X-3943-886-1  
 Part No  
 Suit SLVX812, SLVX822  
 Code TB8861

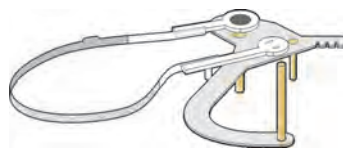

## AKAI MODE SWITCH

Original VT372187, VT363354  
 Part No  
 Suit VS112, 165, VS512,  
 515, VS516, etc.  
 Code SW3721

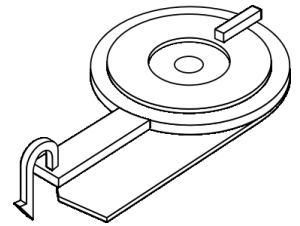

## SONY TENSION BAND

Original X39475891  
 Part No  
 Suit SL-VEZ1, 10, SL-VEZ7,  
 70.  
 Code TB5891

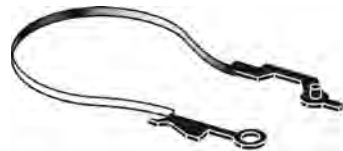

## AKAI MODE SWITCH

Original ES387465J  
 Part No  
 Suit VS422, 425, VS765,  
 965, VSA650, 1100,  
 VSF10, G11, & MORE  
 Code SW3874



### □ Mode Switches

### □ Akai

## VIDEO SWITCHES

FRONT PANEL SWITCHES  
 CASSETTE-IN SWITCHES  
 RECORD SWITCHES  
 MODE SWITCHES  
 ROTARY SWITCHES  
 ROTARY ENCODERS  
 SLIDE ENCODERS

**MORE AVAILABLE SEE:**

<http://www.wes.com.au/>



## AKAI MODE SWITCH

Original ES353653A  
 Part No  
 Suit VS202, 303, VS603,  
 606 VS607, etc.  
 Code SW3536

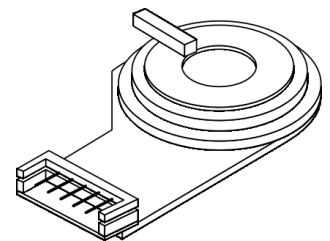

## AKAI MODE SWITCH

Original ES-381310J1  
 Part No  
 Suit VS22, 26, 35, VS53,  
 66, 75, VCA77, R8, etc.  
 Code SW3813



## MICRO PUSH SWITCHES

Most videos use  
 common types and  
 some are brand specific.  
 For our entire switch  
 range see:

<http://www.wes.com.au/>

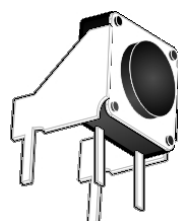

## AKAI MODE SWITCH

Original ES433595,  
 047K120340-01  
 Part No  
 Suit VSG280, VSG2DPL,  
 VSG765, 790, 875.  
 Code SW4001

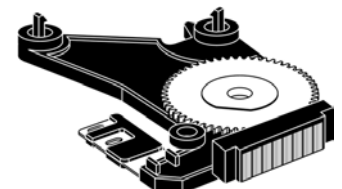



## Deitron / Tempest / Tracton

### DIETRON / TEMPEST / TRACTON

Original Part No 5S30407011  
 Suit TE99R,970R, VCR32,52,8052, DVR6158D,etc.  
 Code SW3040

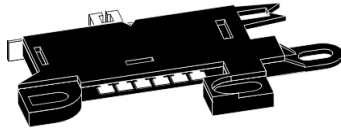

## Funai / Teac

### FUNAI SWITCH ASSEMBLY

Original Part No 8059-16-320  
 Code FU1620

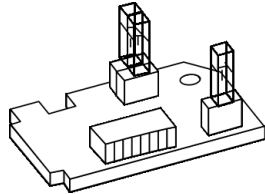

### FUNAI LEAF SWITCH

Original Part No 6401-01-151  
 Code SW1151

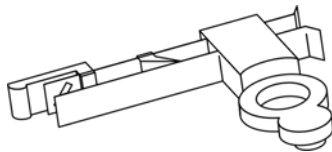

### FUNAI TEAC MODE SWITCH

8000-22-304, WA-03VO, 6 pin

Suit MV300, 400, MV430, 435, MV1400, 1440  
 Code SW3105

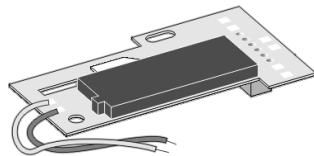

### FUNAI TEAC MODE SWITCH

62D806513302 Board & connectors.

Suit MV3010, 3030, MV3050, 4010, MV6010, etc, VCR9688, etc.  
 Code SW3302



### FUNAI TEAC MODE SWITCH

Original Part No SSR0104HD004  
 Suit MV3420, MV4820.  
 Code SW0004

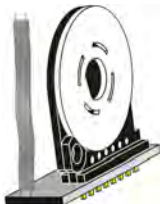

### FUNAI TEAC MODE SWITCH

Original Part No 5S10104100  
 Suit MV3094  
 Code SW4100



## FUNAI TEAC MODE SWITCH

Original Part No 5SSF1DKM10, MMSS00320ZMB0  
 Suit D284 D884, DVK10 224 424 824, MV3080 3092 4090, MV6080 6090 6092  
 Code SW3200



## Goldstar

### GOLDSTAR MODE SWITCH

Original Part No 556-115A  
 Suit VCP100,101, VCP110,115, VCP120,126, KVP120,etc.  
 Code SW6115

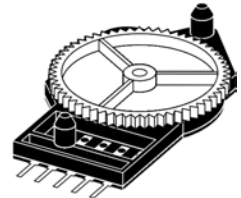

### GOLDSTAR MODE SWITCH

Original Part No 556-085A  
 Suit GHV1290,1295, GHV1910,4300, GHV4310,4320, AV64,etc.  
 Code SW5560

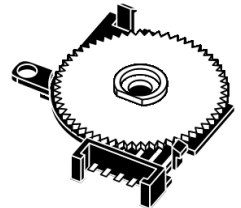

### GOLDSTAR MODE SWITCH

Original Part No 556-055B  
 Suit GHV1232,1240, GHV1241,1247, KBV9012,AV61/2, VCP4100,R7000, and more...  
 Code SW6055

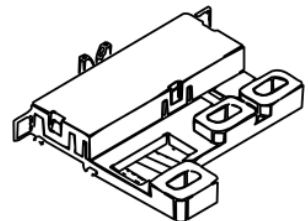

### GOLDSTAR MODE SWITCH

Original Part No 556-133A  
 Suit AV66, RG20. and more...  
 Code SW6133

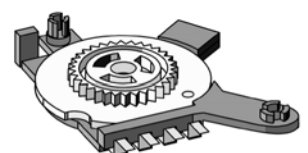

### GOLDSTAR / NEC MODE SWITCH

Original Part No 556-252A & B, NEC 79VG1093 VN36  
 Suit P23H, P433H, P933H, RN800H, RN830H, T293H, T493H, VHG104, VNG67.  
 Code SW6252



## Hitachi

### HITACHI MODE SWITCH

Original Part No 5625141  
 Suit VT100,110, VT111,125, VT128,138, VT150....  
 Code SW5141







## HITACHI MODE SWITCH

Original Part No 5625061  
 Suit VT11,14, VH600, VT9300,etc.  
 Code SW5061

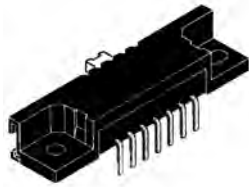

## HITACHI MODE SWITCH

Original Part No 5625091  
 Suit VT17,19,33,34,35,38,52,63,330,640.  
 Code SW5091

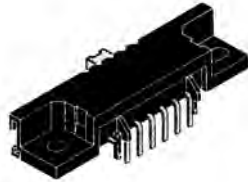

## □ JVC

### JVC SLIDE ENCODER

Suit Code  
 HRD170,171,180,210,230, PU58642  
 HRD320,470,530.  
 HRD227,380. PU59924



### JVC SLIDE ENCODER

Suit HRD300,337, HRD400,441, HRD700,750, HRS5000,5500, HRS9000,etc.  
 Code PU60444

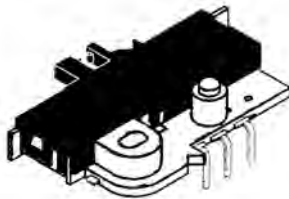

### JVC SLIDE ENCODER

Original Part No PU60973-1-1  
 Suit HRD540,580  
 Code PU60973

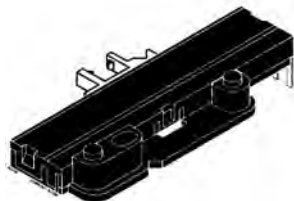

### JVC SLIDE ENCODER

Suit HRD520, 521, HRD830, 600, HRDX20, 22, HRJ200, etc.  
 Code PU60622



### JVC SLIDE ENCODER

Original Part No PU61247-1-1  
 Suit HRD640, HRD790, HRD910  
 Code PU61247



## JVC SLIDE ENCODER

Suit HRJ600  
 Code PU61322-1-2

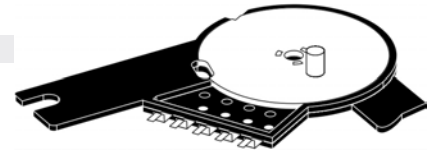

## JVC ROTARY ENCODER

Suit HRJ220, 221, HRJ625, etc.  
 Code PU61432-1-1

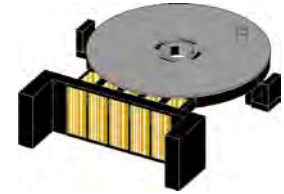

## JVC / PHILIPS ROTARY ENCODER

Original Part No QSW0554-02, 4822-273-10349  
 Suit HRJ255, 455, HRJ655, 755. VR288, 388.  
 Code SW5402

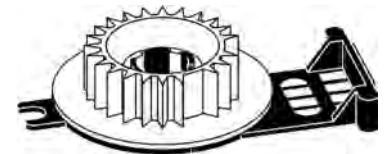

## JVC RECORD PROTECT

Original Part No PU60624-1-4, PU60624-1-5  
 Suit HRDX20, VR3241/75  
 Code PU60624

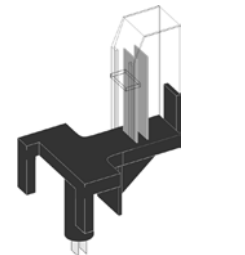

## □ LG

### LG MODE SWITCH

AKAI SANYO GOLDSTAR

Original Part No 6600RPY001B  
 Suit LG AC, AF, BC, SANYO VHR, NEC VN, VNG, AKAI VCJ, etc.  
 Code SW6600



## □ Mitsubishi

### MITSUBISHI MODE SELECTOR

GREY COG

Original Part No 439P011020  
 Suit HS337,338, HS347,411, HS421,etc..  
 Code SW1102





## MITSUBISHI MODE SWITCH

### GREEN COG

Original 439P011040  
 Part No  
 Suit HSE10, 20, 30  
 Code SW1040



## MITSUBISHI MODE SWITCH

Original 439P007010  
 Part No SWITCH ONLY  
 Code SW7010



## MITSUBISHI MODE SWITCH KIT

COMPLETE KIT  
 Manufacturer recommends:  
 Replace one,  
 Replace them all!

Original 439P007010  
 Part No  
 Code KT7010

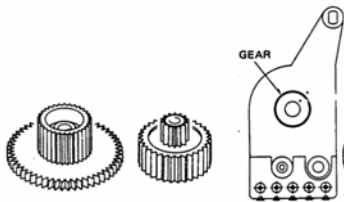

## MITSUBISHI CASSETTE SWITCH

Original 439P00802  
 Part No  
 Suit AV12,51, 400, TR102, etc.  
 Code SW8020

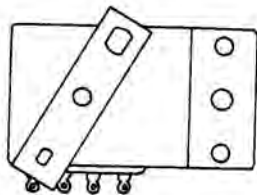

## MITSUBISHI MODE SWITCH

Original 439D03901, 439D039010, 439P03101/0  
 Part No  
 Suit HSM50,X3, HSMX5,X7, HSMX10, 20.  
 Code SW3901

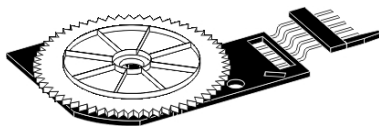

### NEC

## NEC MODE SWITCH

Original 5S10407058  
 Part No  
 Suit VN20  
 Code SW7058

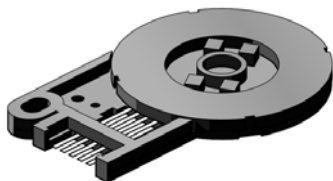

## NEC MODE SWITCH

Original 79TD3895  
 Part No  
 Suit VN22, 25  
 Code SW3895

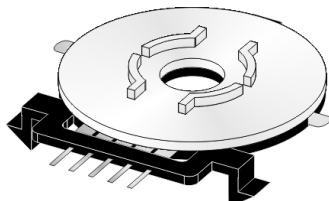

## NEC MODE SWITCH

Original 5SSFMDKM10, MMA0018OZBO, 79TD3598  
 Part No  
 Suit VN23,26,64, AWA 2H20D, AWA 4H40D, etc  
 Code SW3598

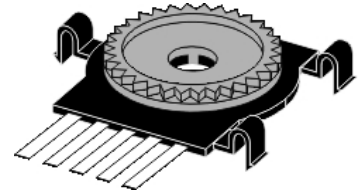

## NEC MODE SWITCH

Original 65909041  
 Part No  
 Suit N9000 series.  
 Code SW9041

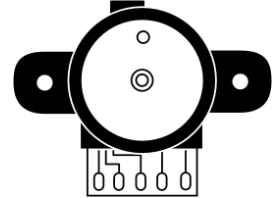

### National

## NATIONAL MODE SWITCH

Suit NV2000, 3000, 7000, 7200  
 Code VSS0048

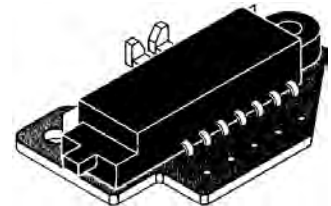

## NATIONAL MODE SWITCH

Suit NV300, 340, 600, 777, 788  
 Code VSS0060

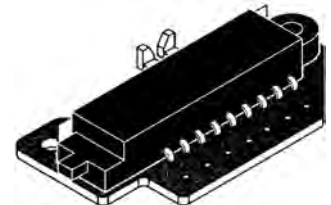

## NATIONAL MODE SWITCH

Suit NV370,380,480,630, NV730,770,780,850.  
 Code VSS0091



## NATIONAL MODE SWITCH

Suit NVG7, 9, NVG10, 11, NVG12, 16,  
 Code VSS0135

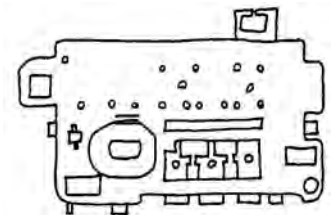

## NATIONAL MODE SWITCH

Suit NV100  
 Code VSS0061

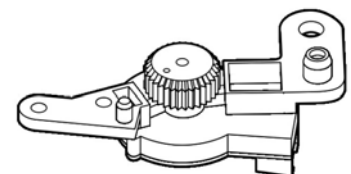



## NATIONAL MODE SWITCH

Suit NV250, 280,  
NV450, 470,  
NV870, etc.  
Code VSS0110

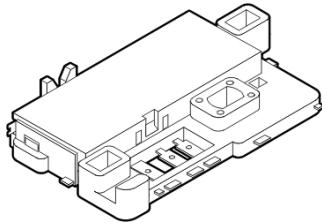

## NATIONAL MODE SWITCH

Suit NVG20, 22, 25, 33, 40, 45  
NVH65, H75, L20, L25,  
RTV560, 740, etc..  
Code VSS0175A EVQWXD001



## □ Panasonic

### PANASONIC MODE SWITCH

Suit NVG30  
Code VES0327

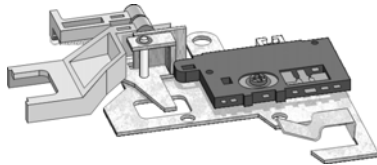

### PANASONIC MODE SWITCH

Suit NVSD10A,  
NVSD20A,  
NVSD30A  
Code VSS0365

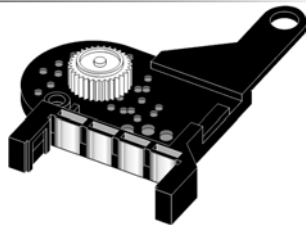

### PANASONIC MODE SWITCH

Original Part No VSS0520  
Suit NVSD220, 270,  
NVSD420,  
NVHD620, 670.  
Code VSS0520

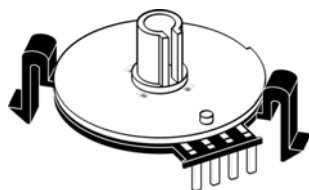

### PANASONIC CASSETTE UP/DOWN SWITCH

Suit NV300, 370, 600,  
777, 788 etc.  
Equiv. VSM0046  
Code VSM0048



### PANASONIC SAFETY TAB SWITCH

Suit NV300, 600,  
NV777, 788, etc.  
Code VSM0043

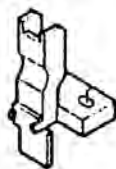

## □ Orion

### ORION MODE SWITCH

Original Part No 0520244002  
Code SW4002

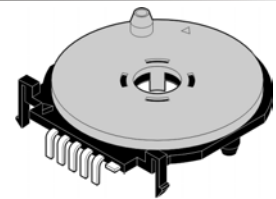

### ORION MODE SWITCH

Original Part No 0520244003  
Code SW4003

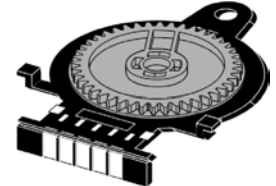

## □ Samsung

### SAMSUNG/TEMPEST MODE SWITCH

Original Part No 9000-221-4109  
Suit VB627, VB629  
Code SW6900

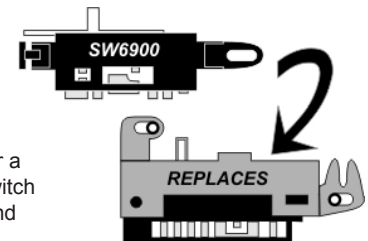

This switch will substitute for a Samsung/Tempest mode switch used in VB900, VB2215B and TE900. With info.

### SAMSUNG MODE SWITCH

Original Part No 63579-101-026  
Suit VB1230  
Code SW1026

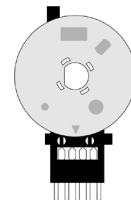

### SAMSUNG MODE SWITCH

Original Part No AC3420100A  
Suit SV240B  
Code SW0100



## □ Sanyo

### SANYO/FISHER MODE SWITCH

Original Part No 4-2314-00251,  
Also 621-006-4030  
Suit FVH-P series.  
Code SW4030

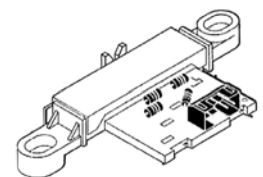

### SANYO MODE SWITCH

Original Part No 645-007-1560  
Suit VHR510, 530,  
VHR590, 610,  
VHR630, 650  
Code SW1560

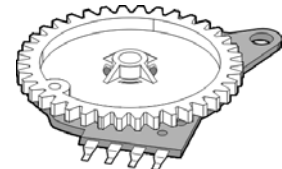



# Video Repair Parts

## SANYO MODE SWITCH

Original 613-110-0374,  
Part No 613-077-4361  
Suit VHR4100,5700,  
Code SW4361

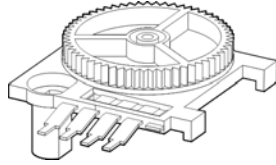

## SHARP MODE SWITCH

Original QSW-R0026GEZZ  
Part No  
Suit VCA30, 35,  
VCA115, 125.  
Code QSWR0026

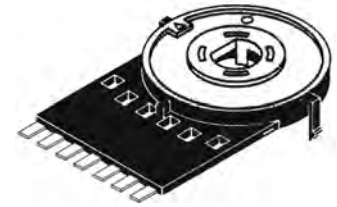

## SANYO/FISHER MODE SWITCH

Original 610 064 783, Also  
Part No 4 231V 86200  
Suit VHR1100,  
VHR1300,  
VHR1500  
Code SW6200

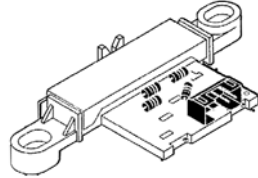

## SHARP CASSETTE IN SWITCH

Original QSW-F0004GEZZ  
Part No  
Suit 300/9000 series.  
Code QSWF0004

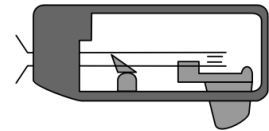

## SANYO/FISHER MODE SWITCH

Original 4-231V-86500,  
Part No Also 613-006-4820  
Suit VHR2500  
Code SW4820

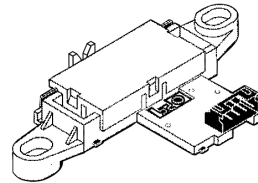

## SHARP SWITCH

Suit many models.

Original QSWF0011GEZZ  
Part No  
Code QSWF0011

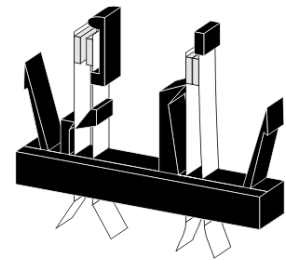

## SANYO/FISHER MODE SWITCH

Original 4-231V-87400,  
Part No Also 613-006-4936  
Suit VHR3500,  
VHR3700, etc.  
Code SW4936

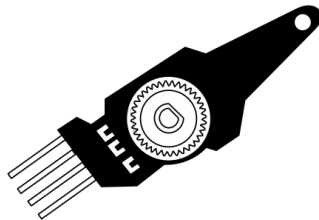

## SHARP CASSETTE IN SWITCH

Original QSW-F0021GEZZ  
Part No  
Suit DAEWOO,  
DEITRON,  
TEMPEST.  
Code QSWF0021

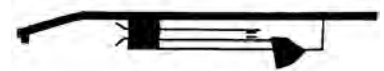

## SANYO REC SAFETY SWITCH

Original 4-231V-8700  
Part No  
Suit VHR3100 etc.  
Code SW8700

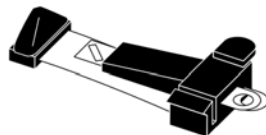

## SHARP LEAF SWITCH

Original QSW-F0023GEZZ  
Part No  
Suit VC51B  
Code QSWF0023

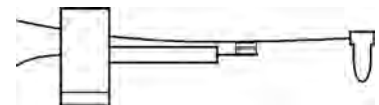

### Sharp

## SHARP MODE SWITCH

Original QSW-R0014GEZZ  
Part No  
Suit VC581, VR6441.  
Code QSWR0014

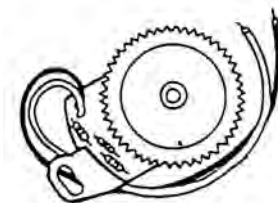

## SHARP REC SAFETY SWITCH

Original QSWF0034GEZZ  
Part No  
Suit VCA10,34,40,49,  
VCA105,125,  
VCB20,60,H91,  
VR3360,6349,  
VT3480, etc.  
Code QSWF0034

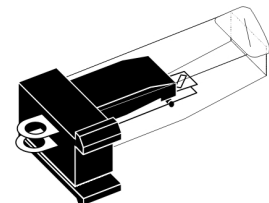

## SHARP MODE SWITCH

Original QSW-R0019GEZZ  
Part No  
Suit VCA502, VCH851,  
etc.  
Code QSWR0019

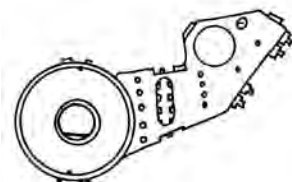

## SHARP SWITCH

Original QSWR0034GEZZ  
Part No  
Suit VCH88, 91, 95,  
VT3418, 5118.  
Code QSWR0034

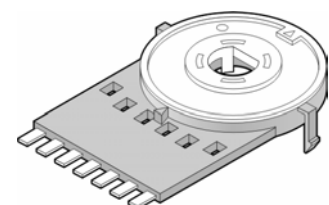





## SHARP MODE SWITCH

**Original Part No** QSWR0008GEZZ,  
QSWR0010GEZZ,  
480227617213

**Suit** MV640, 740, VC5F3,  
VC383, 481, 584, 9300,  
VR401, 6840, VRD012

**Code** QSWR0010

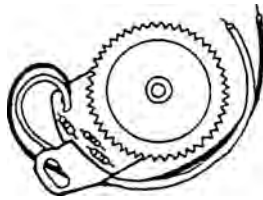

## SHARP MODE SWITCH

**Suit** VC651, 682,6V3,6442,  
VR6520,6542.

**Code** QSWR0017

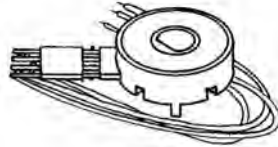

## SHARP MODE SWITCH

**Original Part No** QSWR0023GEZZ

**Suit** VC780,790, VCA105,A111,  
VCA505,D805, VCH855,...

**Code** QSWR0023

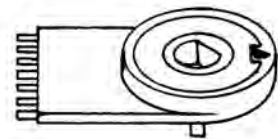

## SHARP MODE SWITCH

**Original Part No** QSW-S0032GEZZ

**Suit** VC381,386, VC388,390,  
VC9300, VR501,601,  
VRD022,etc...

**Code** QSW-S0032

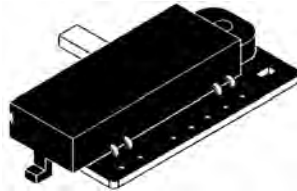

## SHARP CASSETTE-IN SWITCH

**Original Part No** QSWF0010GEZZ

**Suit** MP121,MV740,  
VC387,482,581,....  
VC4842,8482, VR6440,6641,  
VR6840,6937

**Code** QSWF0010

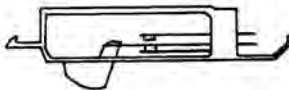

## SHARP SWITCH

**Original Part No** QSW-F0013GEZZ

**Suit** VC381,383,390,  
VR501,601,701, and more

**Equiv.** QSW-M0014GEZZ, QSW-M0019GEZZ

**Code** QSWF0013

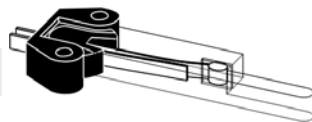

## SHARP ROCKER SWITCH

**Original Part No** QSW-F0022GEZZ

**Suit** VC200,500,651,  
VC682,6F3,779,  
VC785,787,793,  
VCA101,103,502,  
VR6443,6543,etc.

**Code** QSWF0022



## SHARP LEAF SWITCH

**Original Part No** QSW-F0024GEZZ

**Suit** VC51B, VCA101, VR6443,  
More.

**Code** QSWF0024

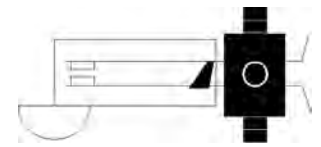

## SHARP SWITCH

**Suit** 14VT10X,  
VCA10,30,40,60,  
VCA105,115,125,  
VCB20,60,D810,  
VCH80,855,S1000,  
VR3360,6448,etc..

**Code** QSWF0040

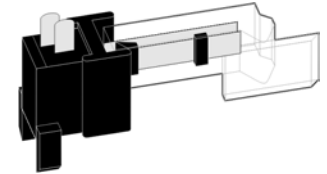

## SHARP CASSETTE SWITCH AND PCB

Complete PCB, switch  
and components, etc.

**Original Part No** Old QSW-F0035GEZZ,  
New DUNTK3194HE00

**Suit** VCA111X and others.

**Code** KT3194

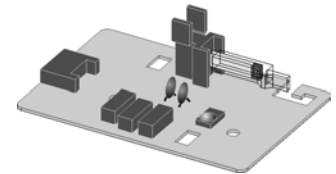

## □ Sony

## SONY MODE SWITCH

**Original Part No** 1-692-062-11

**Suit** SLV715, SLV810\*,  
SLV811, SLV815

**Code** SW2012

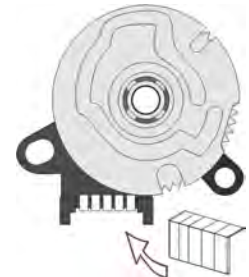

## SONY MODE SWITCH

**Original Part No** 177115511

**Suit** SL-VEZ1, 10,  
SL-VEZ7, 70.

**Code** SW5511



## SONY MODE SWITCH

**Original Part No** 1-762-490-11,  
1-762-076-11

**Suit** SLVX812,  
SLVX822

**Code** SW9011



## SONY FACIA ROTARY SWITCH

FF/REW Rotary  
PLAY/STOP Push

**Original Part No** 1-572-662-11

**Suit** SLVF10,  
SLVX810

**Code** SW6211





# Video Repair Parts

## Mode Sensors

### Universal Lamps

#### VCR SENSING LAMP

Volts	Code
6	SL74-6
12	SL74-12



#### VCR SENSING LAMP

Suit older units

Volts	Code
12	SL79-12
6	SL79-6



## JVC

### JVC SENSING LAMP

Suit HR7200 etc.  
30cm lead.6  
volt,70mA. 4mm  
Diam.

Code
SL15



### JVC SENSING LAMP

As SL15  
Including Plug.  
20cm blue lead.

Code
SL25

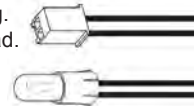

## Akai

### AKAI SENSING LAMP

VS1, 2, 3, 4, 5 etc.  
12V 60mA. 50cm  
lead.

Code
SL40



### AKAI LAMP & HOLDER

Same as SL40

Code
SL42

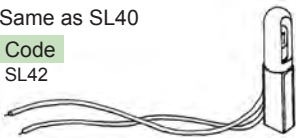

## Sharp

### SHARP SENSING LAMP

300 & 900 series 5V,  
110mA, 18cm lead.

Code
SL50



### SHARP LAMP & HOLDER

As SL50

Code
SL52

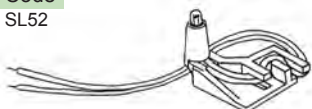

## LG / Goldstar

### GOLDSTAR SENSOR

Suits many models  
and many brands.

Original Part No	513-194D
Code	LN3194



## National

### NATIONAL PHOTO DIODE

Used in National  
and other VCR's.

Code
PN202S-R



### NATIONAL PHOTO DIODE

Used in National  
and other VCR's.

Code
LN58



### NATIONAL PHOTO DIODE

Used in National  
and other VCR's.  
Equiv. to GL450

Code
LN59



### NATIONAL PHOTO DIODE

Used in National  
and other VCR's.

Code
PN150



### NATIONAL PHOTO DIODE

Suit many VCR's.

Code
PN268-R
LN68



### NATIONAL SENSOR

Code
ON2170
ON2270

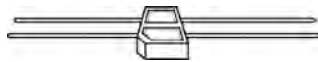

### NATIONAL SENSOR

Used in National  
and other VCR's.

Code
ON2160



## NEC

### NEC LED & HOLDER

Original Part No	16-19-1821
Equiv.	16-18-6441
Code	LN1821

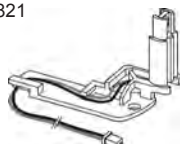

## JVC

### JVC REEL SENSOR

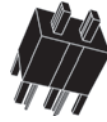

Original Part No	JVC PU61433, Philips 4822 2099 0487
------------------	--

Suit	HRJ220, 425, 635, HRS9400, RV455, VR155, 255, 257, VR357, 455, 755,
Code	PU61433

### JVC PHOTO DIODE

Suit	HRD540, 860, X20, etc...
Code	PU60625

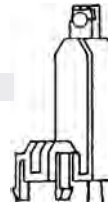

### JVC SENSOR

Original Part No	JVC HR-D725, NEC N895
Code	PU55827

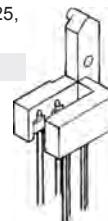

### JVC SENSOR

Original Part No	PU57650-1-1
Suit	HR-D160, 275, 755, etc.
Code	PU57650

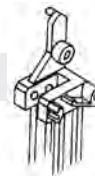

### JVC REEL SENSOR

Suit	HRD540, 580, HRDX20, etc.
Code	PS5705



### JVC REEL SENSOR

Suit	HRD170, 180, 530 HRD520, etc.
Code	PU60271 PU60629

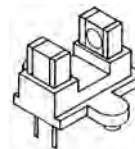

### JVC SENSOR

Suit	HR-D300, etc.
Code	PU58879

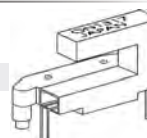

## Sharp

### SHARP PHOTO DIODE

Original Part No	RH-PX0039GEZZ
Code	PX0039



### SHARP SENSOR

Original Part No	RH-PX0042GEZZ
Code	PX0042

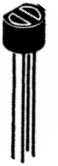

### SHARP CASSETTE SENSOR

Original Part No	RH-PX0169GEZZ, RH-PX0180GEZZ
Suit	VCF410
Code	PX0180



### SHARP IR SENSOR

Original Part No	RHPX0176GEZZ, RHPX0053GEZZ
Code	PX0176



### SHARP SENSOR

Original Part No	RHPX0238GEZZ
Code	PX0238



## Rotational Sensor

### ROTATION SENSOR

Original Part No	RHPX0252GEZZ
Suit	VCA200X
Code	PX0252



## Reel Sensor

### REEL SENSOR

IR TX & RX LEDs	
Code	PS6002A



## Infrared

### INFRARED RECEIVER

Original Part No	NATIONAL PN313B or PH302
Code	PN313



### INFRA-RED RECEIVER

PN323B, PH310,  
ED360409 and  
more!

Equiv.	PH310
Code	PN323



## Components

### SECTION 12

LED Diodes Electronic  
Components Section 12  
COMPONENTS





## □ Misc Parts

### □ Brake Pads

#### AKAI BRAKE PADS

21mm x 5mm  
Supplied in bags  
of 10 pieces.

Code  
ABP10



#### JVC BRAKE PADS

8mm x 2.5mm  
Supplied 10 pcs/bag.

Original PUM30019-2  
Part No  
Code JBP10



#### SANYO BRAKE PADS

21mm x 3.5mm  
Supplied 10 pcs/bag.

Original 613-055-7117,  
Part No 143-2-712T-05200  
Code SBP10



#### ADHESIVE BRAKE PAD / TENSION BAND FELT

Supplied in a sheet  
100mm x 70mm.  
Just cut to size for  
application.  
Light grey colour felt.

Code  
TBF170

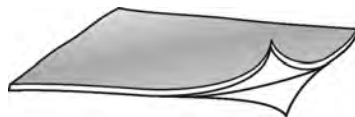

## □ Misc Parts

### JVC KNOB SET

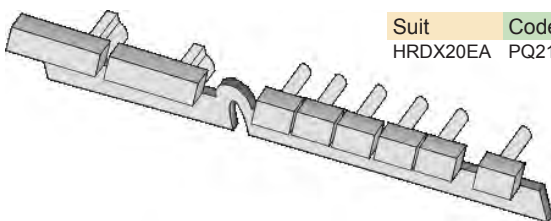

Suit HRDX20EA  
Code PQ21174

### SHARP CRYSTAL

Original RCRSB0090GEZZ  
Part No  
Code CR0090

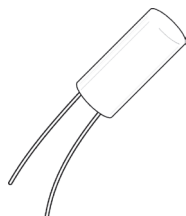

MORE X-TALS SEE SECTION 12  
COMPONENTS

## □ Chroma

### NATIONAL CHROMA PCBs

Code  
VEFC007  
VEFC009  
VEFC013  
VEFC015

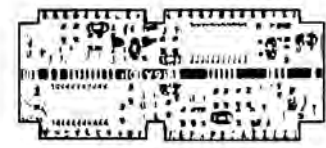

### PANASONIC COLOUR MODULES

Suit Code  
NVG30 VEFH03D  
NVJ1 VEFH04F

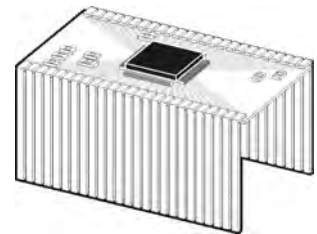

### PANASONIC COLOUR MODULES

Suit NVHD100,  
NVSD1, 10  
Equiv. VEFH29B,  
VEFH29C  
Code VEFH29D



## □ Switchmode Repair

### PANASONIC SWITCHMODE REPAIR KIT

OEM kit by Panasonic. Includes Resistors, Diodes, Transistors,  
Required for repair.

Suit NVSD200, 205,  
NVSD207, 250,  
Code VUE4127KIT



### SONY SWITCH MODE

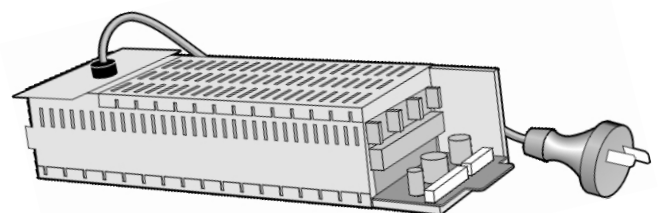

Original 1-413-896-21 1-413-621-11 1-413-897-11  
Part No  
Suit SLVX312PS SLV777 SLVX835  
Type 8 Pin  
Code PS9621 PSM2111 PSM9711





# Video Repair Parts

## □ Servicing Tools and Accessories

### UNIVERSAL REMOTES See Section 01

We sell a comprehensive range of pre-programmed and programmable remotes for replacing damaged remotes and/or combining all your remotes into one.

Different styles and features available.

See section 01 AV TV SAT Install  
From ONLY \$15.50 !



### REMOTE CONTROL REPLACEMENT CABLES

6M in length with molded plus & grommets. 3 Types of plugs.

Type	2.5mm plug	3.5mm plug
Code	RCC25	RCC35



### RUBBER KEYPAD REPAIR KIT

#### REMOTE CONTROL REPAIR

Restores conductivity to worn carbon contacts on remote controls & keypads. Repairs are good for at least 500,000 keystrokes. Carbon/silver solution.

#### 50 Applications

Code  
CW2605



### SECURITY TAMPER LABELS

#### "WARNING - WARRANTY VOID IF SEAL BROKEN OR TAMPERED WITH."

Place over screws and seals to prevent tampering. Suit repair shops, etc. Special type sticker that will not peel off in one go. Convenient dispenser box. Roll 500 pieces

Code  
WL500

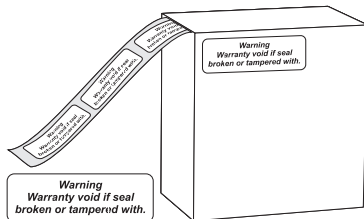

### UNIVERSAL HEAD EXTRACTOR TOOL

Extract VCR heads without damage to either head or mounting assembly. Adjustable so as to suit various brand heads.

Code  
HT800



VIDEO HEAD NOT INCLUDED  
EXTRACT VIDEO HEADS SAFELY AND ACCURATELY

### COTTON GLOVES

Eliminate the need to clean heads after fitting by using gloves. Recommended by leading manufacturers. Sold in pairs.

Code  
GLV2



### MECHANICALS GREASE

#### PLASTICS GREASE

Plastic to Plastic or Metal.

Size Code  
35ml SPG35SL



#### MOLYKOTE DX PASTE

White Grease for Surfaces & Bearings.

Size Code  
50g MK6195



#### MOLYKOTE BR 2 PLUS

Metal bearings, etc.

Size Code  
100g LM47



### HAND TOOLS

For our comprehensive servicemans tool range please see section TOOLS & TEST EQUIPMENT

#### PEARL CATCHER

Oops! Retrieve dropped screws.

Code  
PU5



#### DENTIST MIRROR

Look behind things.

Code  
HT922



Please see section 07 TOOLS & TEST EQUIPMENT

### DOOR CATCH

#### FRONT FLAP CLOSE

As found on front door flaps on VCRs, DVDs, etc. Push to open  
Push to close

Code  
DL1902

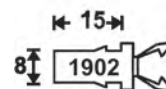





## GENERAL PURPOSE VHS TEST TAPE

This tape is designed as a preliminary service test tape for standard VCR's. Its cost effectiveness makes it suitable for initial fault finding and mechanical checking. It contains 30 minutes of colour bar signal and 1KHz audio tone.

Code  
VID50



## ELECTRONIC TOOL WALLET

### 25 PIECE REPAIR KIT

An excellent variety of common electronic repair tools for the technician Soldering/De-Soldering, Screw drivers, Cutters, all manner of handy items Zip-Case 285x195x50mm

Code  
GTK030B

More tools; See Section 07  
TOOLS & TEST EQUIPMENT



## PRECISION VHS ALIGNMENT TAPE

Highest Quality recording. Suit final alignments.  
8 min RF Sweep  
8 min Colour bars 3KHz Tone  
8 min Staircase Monoscope 333Hz Tone  
6 min Crosshatch, Linearity (circle & border)

Code  
VID70



## VCR ALIGNMENT TOOLS

Three types are available to adjust AC heads, video heads, tape guide path, transport, etc.

Code HT36

HT87

HT89



## VHS HI-FI ALIGNMENT TAPE

Includes 3KHz & 333Hz tones in linear & HiFi, Standard RF Sweep, etc. Ideal for final alignment. Master Tape.  
8min Colour Bars  
8min Stair Step  
8min Circle & Border  
8min RF Sweep

Code  
VID75



## HAND ASSIST TOOLS

A collection of assorted hand tools scribes, hooks, blades, brushes, etc. designed to assist technicians in repair and servicing. Premium quality. Made in Japan.

Code  
SA10



## TRANSPARENT VHS WORKING CASSETTE

VCR servicing is made easier with this tape simulator. All functions normally but now you have access to the parts of the mechanism. Saves time and chewed tapes! Now with door tab simulator. Clear plastic.

Code  
VID5041



## TOOLS & TEST EQUIPMENT - SECTION 07

SEE SECTION 07 TOOLS & TEST EQUIPMENT

We also stock a large range of hand tools like screwdrivers needle-nose pliers NEW! Screw head pliers! Cutters, crimpers, seizure clamps, assorted sizes of metal & plastic tweezers plus lots more!





# Video Repair Parts

## CAMCORDER HEADCLEANER

Can be used wet or dry. Supplied with cleaning fluid. Non-abrasive

Type VHS-C 8mm  
Code HL206 HL205



## CASSETTE ADAPTOR VHS-C

Adapts the compact camcorder cassette to the normal size. VHS-C Cassettes ONLY! S-VHS Compatible [ NOT 8mm/Hi-8 ] REQUIRES "AA" BATTERY

Code EL303E

NOT FOR 8mm!



## HEAD CLEANER VHS

Non-Abrasive polyester to clean the entire tape path. Includes cleaning solution. Note this tape does not have a leader tape and may not function as expected in some machines.



## EXTRA CLEANING SOLUTION

Code CS500

## SUPER QUALITY VIDEO HEAD CLEANERS

Chamois Tip with 45° shaft. Packaged 10 per bag.

Code VCS10



## VIDEO SPLICE KIT

Repair or modify VHS or BETA tapes with this splicing jig for precise control of cut & pasting. Includes jig, press, blade, adhesive tape and VHS & BETA leader tapes.

### KIT

Code PC8101

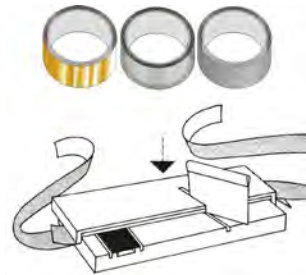

## VIDEO CLEANING SWABS

Lint-less foam swabs with a strong shaft. Packaged 20 per bag.

Code VCS20



Full Range In Section 07  
TOOLS & TEST EQUIPMENT

## VIDEO SPLICING TABS

Splice tabs for 1/2" video tape. Order one to receive a packet of 90.

Code MK32



## HEAD CLEANING SPRAY

Our full range is found in the Section TOOLS & TEST EQUIPMENT

**ELECTROLUBE 270g**  
Spray can non-residue Video Head Cleaner

Code VID400M



## VIDEO TAPE SPLICER KIT

Defeats all hassles with repairing and modifying video cassette tapes. This handy unit has clips for holding the door open and releasing the reel ratchet. A grooved plate allows easy alignment of the tape with "fingers" to hold it in position. Also includes a guillotine blade for accurate & neat splicing of the video tape. Suitable for both VHS & BETA tapes. Comes with instructions and splice tabs. Edit and repair is easy now.

Code SV620

## REPLACEMENT TABS

Splice tabs for 1/2" video tape. Order one to receive a packet of 90.

Code MK32

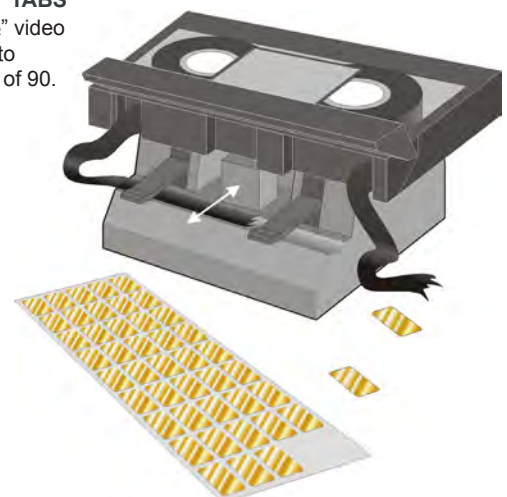



## VHS VIDEO CASSETTE

Long-Life Anti-Fungus Treatment provides high reliability for long-term storage.

Brand	Maxell*
Time	180 min
Code	ME180GX



## 8mm VIDEO CAMERA CASSETTE

To suit the Video-8 format Japan quality & durability\*  
Sony or TDK may be supplied Depending on availability\*

Time	85min
Code	V8085



## TDK

Extra High Grade ideal for archiving extra special recordings.

Brand	TDK
Time	180 min
Code	EHGE180



\*Brand may change to continue stock.

## MINI-DV DIGITAL VIDEO CASSETTE

### DVC CAMCORDER CASSETTES

Brand	Type	Time	Code
Panasonic	SD	83minLP 55minSP	DVM83PQ
Panasonic	SD	90minLP 60minSP	DVC090
Sony	HD	94minLP 63minSP	DVM63HD

\*Brands may change to continue stock.



## S-VHS SUPER VHS CASSETTE

### Super-VHS PRO 240 Min

Absolute premium solution High density magnetic tape With S-VHS identity tag as required to work as S-VHS TDK or JVC or FUJI Brands may be supplied. 240 Min.

Code	SVHS240
------	---------



Brand may change to continue stock.



## VIDEO CASSETTE COVERS

Video cassette storage cases for VHS and BETA  
Fitted with outer sleeve

Colour	Clear Black
Code	VCC2 VCC4

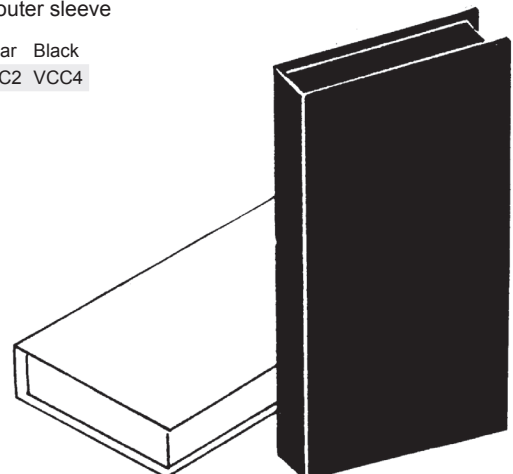





# Video Repair Parts

■ <b>Cassette Housings</b> .....	<b>80</b>	■ <b>Overhaul Kits</b> .....	<b>30</b>
■ Akai .....	80	■ JVC OEM .....	30
■ Daewoo / Tempest .....	80	■ JVC Replacement .....	32
■ Funai / Teac / Palsonic .....	80	■ National Panasonic OEM .....	31
■ JVC / Philips .....	80	■ National Panasonic Replacement .....	32
■ LG / Goldstar .....	80	■ <b>Pinch Rollers</b> .....	<b>25</b>
■ Mitsubishi .....	81	■ Akai .....	25
■ Panasonic .....	81	■ Daewoo .....	25
■ Samsung .....	81	■ Funai / Teac .....	25
■ Sanyo .....	82	■ Goldstar / LG / NEC .....	25
■ Sharp .....	82	■ Hitachi .....	25
■ Sony .....	82	■ JVC / Phillips .....	26
■ <b>Idlers &amp; Gears</b> .....	<b>33</b>	■ Mitsubishi .....	26
■ Akai .....	33	■ National .....	26
■ Daewoo / NEC / AWA / Tempest .....	36	■ NEC .....	26
■ Funai / Teac / Palsonic .....	38	■ Panasonic .....	27
■ Hitachi .....	44	■ Philips / Teac .....	27
■ JVC .....	45	■ Samsung .....	27
■ LG / Goldstar / NEC / Teac .....	40	■ Sanyo .....	27
■ Mitsubishi / AWA .....	52	■ Sharp .....	27
■ NEC .....	54	■ Sony .....	27
■ Orion .....	55	■ Video Pinch Roller Listing .....	28
■ Panasonic .....	55	■ <b>Motors</b> .....	<b>9</b>
■ Samsung .....	63	■ Akai .....	9
■ Sanyo / Fisher / Sony .....	66	■ Daewoo .....	10
■ Sharp .....	68	■ Funai / Teac / Palsonic .....	10
■ Sony .....	75	■ Goldstar / LG .....	10
■ Teac / Philips .....	79	■ Hitachi .....	10
■ Toshiba .....	79	■ JVC .....	11
■ <b>Misc Parts</b> .....	<b>95</b>	■ LG / Goldstar .....	12
■ Brake Pads .....	95	■ Mitsubishi .....	13
■ Chroma .....	95	■ National .....	14
■ Misc Parts .....	95	■ NEC .....	14
■ Switchmode Repair .....	95	■ Panasonic .....	14
■ <b>Mode Sensors</b> .....	<b>94</b>	■ Philips .....	15
■ Akai .....	94	■ Samsung .....	15
■ Components .....	94	■ Sanyo .....	16
■ Infrared .....	94	■ Sharp .....	16
■ JVC .....	94	■ Sony .....	19
■ JVC .....	94	■ Teac / Philips .....	19
■ LG / Goldstar .....	94	■ <b>Servicing Tools and Accessories</b> .....	<b>96</b>
■ National .....	94	■ <b>Tension Bands</b> .....	<b>83</b>
■ NEC .....	94	■ Akai .....	83
■ Reel Sensor .....	94	■ Funai / Teac / Palsonic .....	83
■ Rotational Sensor .....	94	■ Hitachi .....	84
■ Sharp .....	94	■ JVC .....	84
■ Sharp .....	94	■ LG / Goldstar .....	83
■ Universal Lamps .....	94	■ Mitsubishi .....	84
■ <b>Mode Switches</b> .....	<b>87</b>	■ NEC .....	85
■ Akai .....	87	■ Panasonic .....	85
■ Deitron / Tempest / Tracton .....	88	■ Samsung .....	85
■ Funai / Teac .....	88	■ Sanyo .....	86
■ Goldstar .....	88	■ Sharp .....	86
■ Hitachi .....	88	■ Sony .....	87
■ JVC .....	89	■ <b>Video Belts</b> .....	<b>20</b>
■ LG .....	89	■ Belt Kits .....	22
■ Mitsubishi .....	89	■ Cross Reference .....	20
■ National .....	90	■ Idler Tyres .....	24
■ NEC .....	90	■ Video Belts & Idler Tyres .....	23
■ Orion .....	91	■ <b>Video Heads</b> .....	<b>2</b>
■ Panasonic .....	91	■ AC Heads .....	8
■ Samsung .....	91	■ Akai / LG .....	5
■ Sanyo .....	91	■ Funai .....	5
■ Sharp .....	92	■ Hitachi .....	5
■ Sony .....	93	■ JVC .....	5
		■ Samsung .....	5
		■ Video Head Cross Reference .....	6